



Friendly Specialist
SERVICE

The background of the lower half of the page is a dark blue gradient. It features several surgical instruments, including forceps and scalpels, arranged on a surface. The instruments are rendered in a slightly darker shade of blue, creating a subtle, artistic effect.

SURGICAL INSTRUMENTS

Catalogue

PROFILE

HEALPRO INSTRUMENTS who has been in the line of business since 2015 We have extensive experience, and have gained a good reputation in the field of export. Now we, the third generation, are successfully running our business.

Products and Services

We do manufacture and export wide range of Surgical Instruments specialized in Surgical Scissors Instruments. Besides producing standard instruments we also offer our services to produce any specific instrument for our valued customers.

Dedication to Quality

We assure you of superb services and individual attention at all times. Our policy is to achieve excellence through quality performance in meeting our customers' requirements. Throughout the whole production process quality is maintained by watchful in-line supervision, regular and final inspection. Our production units employ the highest quality of raw materials from Pakistan, Germany, France and Japan. HEALPRO is certified by ISO 9001:2008, ISO 13485:2003, CE, cGMP (USA) these guarantee that our instruments are safe and fit for their intended use.

Warranty

All of our products are 100% guaranteed against any defect in raw material and workmanship. Any instruments that prove to be defective, when used for its intended surgical purpose, will be replaced/repared free of cost.



CORPORATE GOAL

To be the market leader in manufacturing world's finest Surgical & Dental Instruments, at the most competitive prices.

Never compromise on Quality!

During the initial years of our formation, we worked hard to precisely understand the requirements of our respected customers, which has gradually improved over time. As our guiding philosophy, we put the concepts of "Customer First" and "Quality First" into practice, to respond to the expectation of our customers.

QUALITY ASSURANCE

Our commitment to the quality ethics and performance of all our instruments is demonstrated by our accreditation to the International quality assurance standards of ISO 9001:2008, ISO 13485:2003, cGMP & CE.

GUARANTEE

Our guarantee is your complete satisfaction.

We take great pride in our reputation for manufacturing "consistent" quality instruments as per our customer's requirements. We offer our customers a complete guarantee when it comes to the workmanship and materials of all our products.

R&D

Our company take R&D as a continuing driving force for the research and development of our Instruments. Our company is well equipped with in-house R&D department, with state of the art machinery, where every piece is put through stringent tests before its final assembling. It provides us ample scope to adapt the needs of our valued clients.

CHILD LABOR POLICY

As good corporate citizens and most importantly as a matter of social responsibility, we are committed to the ideas of protecting children from the exploitations of child labor. We strongly believe that the future growth of children, of their communities and the country as a whole is best served through education, not child labor.



REPAIR & RESTORATION

We offers complete surgical and dental instruments repair and restoration service, utilized in all kinds of operating procedures at very competitive rates.

Our services include, but are not limited to, complete set restoration, instrument customization, gold plating, laser/chemical etching, coding, final finishing, Re-Polishing and most importantly the functional performance of an instrument and its aesthetic appearance.

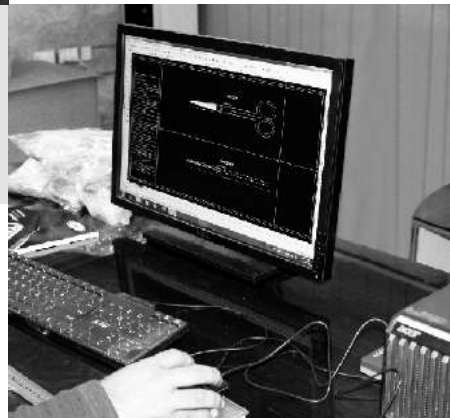

OEM MANUFACTURING

We not only manufactures fine quality surgical instruments, but we also provide complete modification and customization of instrument design according to its specific usage. All OEM instruments are carefully hand crafted with details to guarantee quality and exact specifications.

We can work pretty much on anything, from physical samples to hand drawn sketches, high precision 3D CAD models and drawings.

Our experience and knowledge in hand crafting surgical and dental instruments, combined with modern engineering capabilities, allow us to adopt the finest techniques to apply to each product, to accomplish the outcomes our customers require.



***Your TRUSTED Partner
In Surgical Instruments***



01

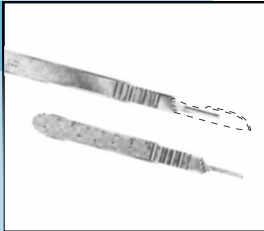

Scalpels

Skalpelle
Bisturis
Escalpelos

Page 01 - 11

02



Scissors

Schere
Tesouras
tijeras

Page 12 - 52

03



Dissecting & Tissue Forceps

Präparierende & Gewebszange
Pinça de dissecação e tecido
Dissección y pinzas de tejido

Page 53 - 71

04



Artery Forceps

Arterienzange
Pinça de artéria
Pinzas arteriales

Page 72 - 106

05



Cotton Swap Forceps

Wattestäbchen
Pinça de cotonete de algodão
Fórceps de algodón

Page 107 - 113

06



Retractors

Wundhaken
Retratores
Retradores

Page 114 - 168

07



Probes

Sonden
Sondas
Sondas

Page 169 - 171

08



Diagnostics

Diagnose
Diagnóstico
Diagnostico

Page 172 - 180

09

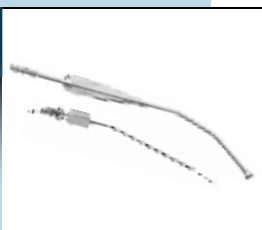

Trocars, Suction Tubes, Cannulas

Trokare, Saugrohre, Kanülen
Trocars, Tubos de Sucção, Cânulas
Trocares, tubos de succión, cánulas

Page 181 - 187

10



Anaesthesia

Anästhesie
Anestesia
Anestesia

Page 188 - 202

11

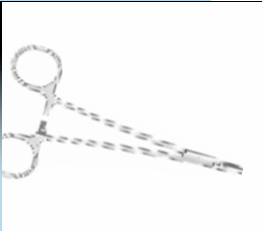

Suture

Naht
Sutura
Sutura

Page 203 - 227

12



Dressing

Dressing
Vestir
Vendaje

Page 228 - 234

13

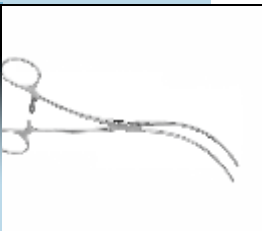

Cardiovascular Surgery

Herz-Kreislauf-Chirurgie
Cirurgia Cardiovascular
Cirugía Cardiovascular

Page 235 - 275

14

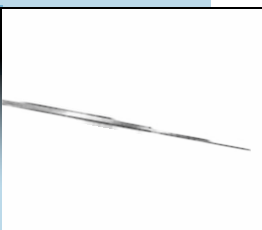

Neurosurgery, Laminectomy

Neurochirurgie, Laminektomie
Neurocirurgia, Laminectomia
Neurocirugía, laminectomía

Page 276 - 330

15



Tracheotomy

Tracheotomie
Traqueotomia
Traqueotomía

Page 331 - 335

16



Dermatology

Dermatologie
Dermatologia
Dermatología

Page 336 - 340

17

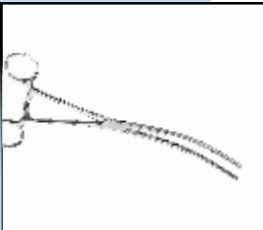

Stomach, Intestines, Rectum

Magen, Darm, Rektum
Estômago, Intestinos, Reto
Estômago, intestinos, recto

Page 341 - 355

18



Liver, Gall Bladder, Kidney and Urology

Leber, Gallenblase, Niere und Urologie
Fígado, vesícula biliar, rim e urologia
Hígado, vesícula biliar, riñón y urología

Page 356 - 366

19

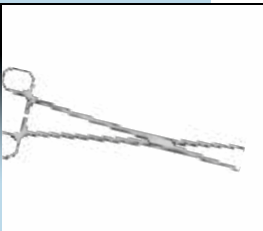

Gynecology

Gynäkologie
Ginecologia
Ginecología

Page 367 - 389

20



Obstetrics

Geburtshilfe
Obstetrícia
Obstetricia

Page 390 - 394

21

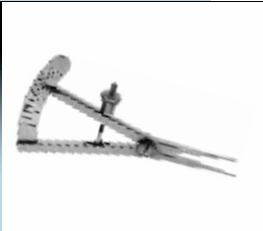

Calipers
Bremssättel
Pinças
Calibrador

Page 395 - 397

22



Otology
Otologie
Otologia
Otología

Page 398 - 412

23



Rhinology
Rhinologie
Rinologia
Rinología

Page 413 - 431

24



Oral Maxillo-Facial Surgery
Mund-Kiefer-Gesichtschirurgie
Cirurgia Maxilofacial Oral
Cirugía maxilofacial oral

Page 432 - 444

25

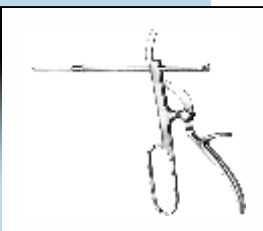

Tonsillectomy, Laryngo-Bronchoscopy
Tonsillektomie, Laryngo-Bronchoskopie
Amigdalectomia Laryngo-broncoscopia
Amigdalectomía, laringoscocoscopia

Page 445 - 449

26

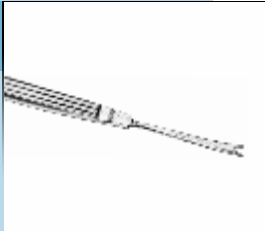

Cranio-Maxillo-Facial Surgery

Cranio-Maxillo-Gesichtschirurgie
Cirurgia Cranio-Maxilo-Facial
Cirugía cráneo-maxilar-facial

Page 450 - 464

27



Holloware

Holloware
Holloware
Holloware

Page 465 - 477

28



Dissecting Kits

Kits zerlegen
Kits de Dissecação
Kits de disección

Page 478 - 480



Scalpels

Skalpelle

Bisturis

Escalpelos

Page 01-09

Dissecting Knives
Messer sezieren
Facas de dissecação
Disección de cuchillos



HP-01-006 - HP-01-010
Fig. 1 - 10
With metal handle

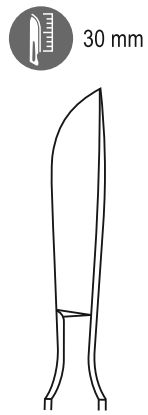

HP-01-001
Fig. 1
15 cm



HP-01-002
Fig. 2
15 cm

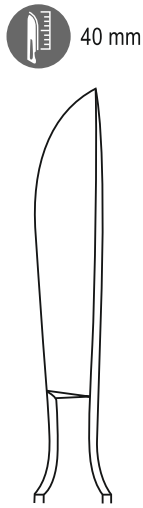

HP-01-003
Fig. 3
15.5 cm

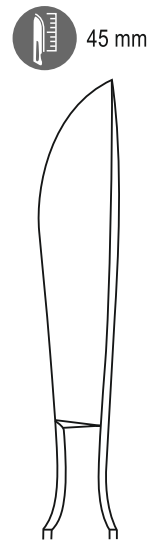

HP-01-004
Fig. 4
16 cm

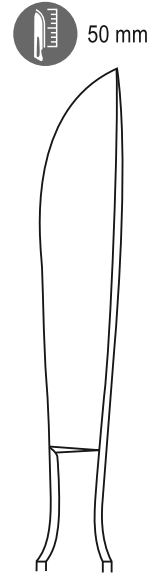

HP-01-005
Fig. 5
16 cm

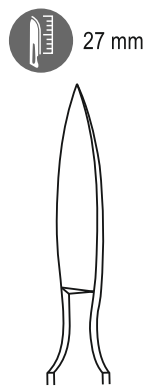

HP-01-006
Fig. 6
15 cm

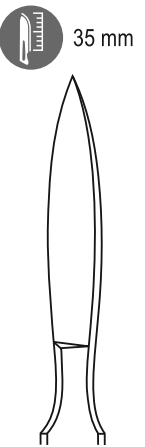

HP-01-007
Fig. 7
15 cm

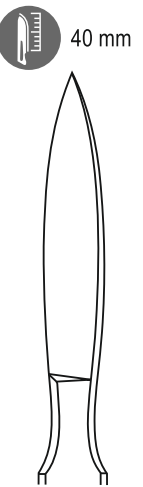

HP-01-008
Fig. 8
16 cm

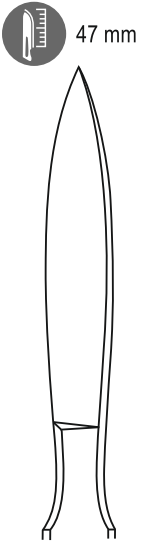

HP-01-009
Fig. 9
16 cm

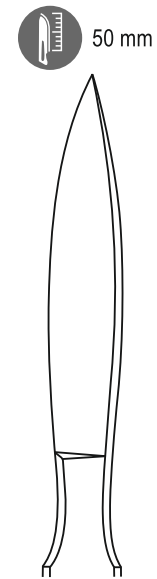

HP-01-010
Fig. 10
17 cm

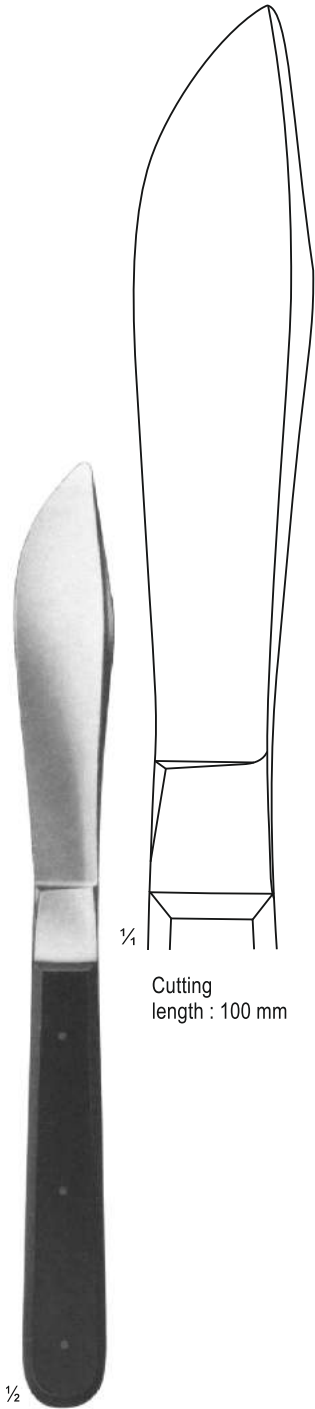

Cutting length : 100 mm

HP-02-011
 25 cm
 With wooden handle

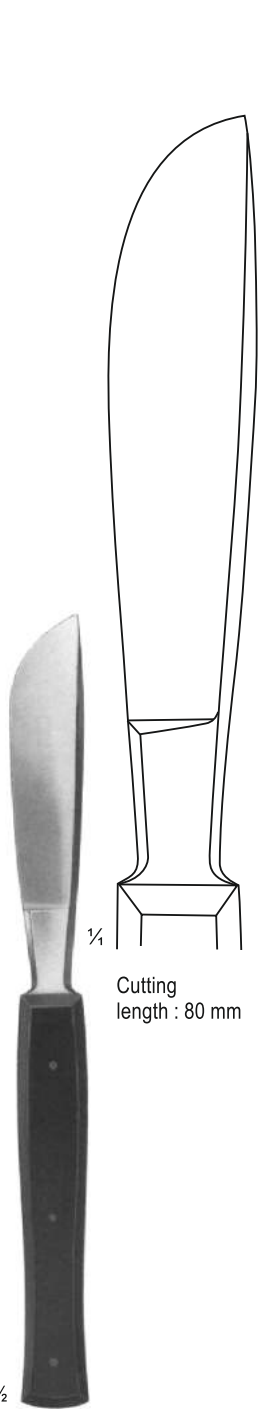

Cutting length : 80 mm

Virchow
HP-02-012
 21 cm
 With wooden handle

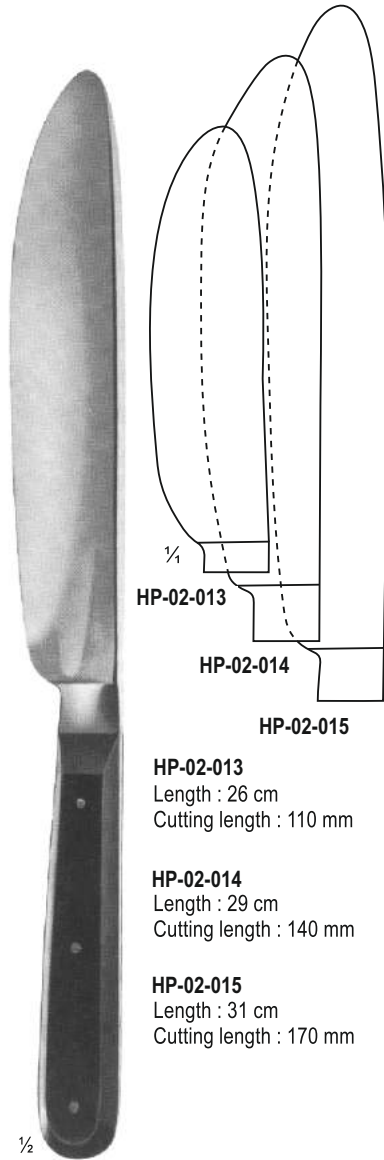

HP-02-013
HP-02-014
HP-02-015

HP-02-013
 Length : 26 cm
 Cutting length : 110 mm

HP-02-014
 Length : 29 cm
 Cutting length : 140 mm

HP-02-015
 Length : 31 cm
 Cutting length : 170 mm

Walb
HP-02-013 - HP-02-015
 With wooden handle

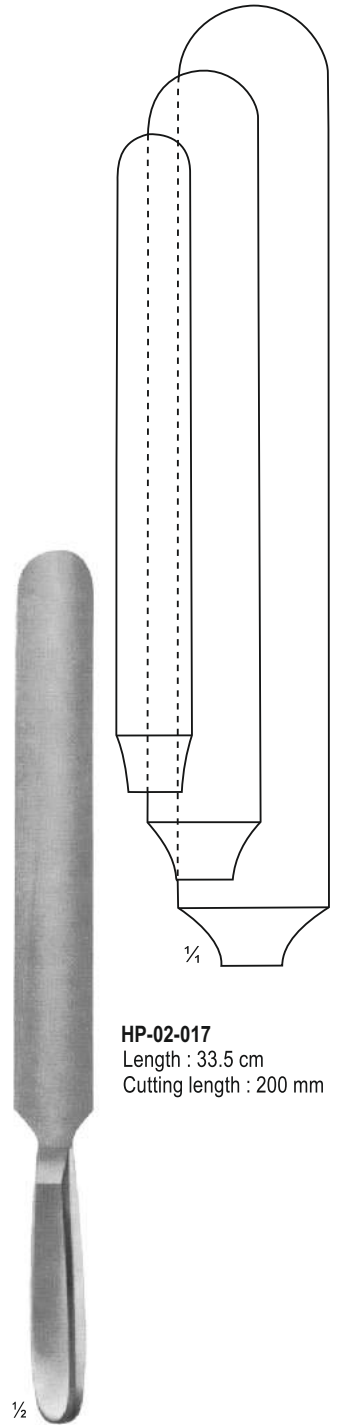

HP-02-017
 Length : 33.5 cm
 Cutting length : 200 mm

Virchow
HP-02-016
 With hollow handle

Amputating, Cartilage, Autopsy Knives, Interosseous Knives
Amputation, Knorpel, Autopsie Messer, Interosseus Messer
Amputação, Cartilagem, Facas de Autópsia, Facas Interósseas
Amputaciones, cartílagos, cuchillos de autopsia, cuchillos interósseos



½

HP-03-018
5.5 cm
Blade length
With raspatory,
Wooden handle



½

HP-03-019
7 cm
Blade length
Wooden handle



½

Langenbeck
HP-03-020
18 cm



½

Langenbeck
HP-03-021
18 cm



HP-04-022 HP-04-023 HP-04-024 HP-04-025 HP-04-026 HP-04-027 HP-04-028 HP-04-029 HP-04-030 HP-04-031

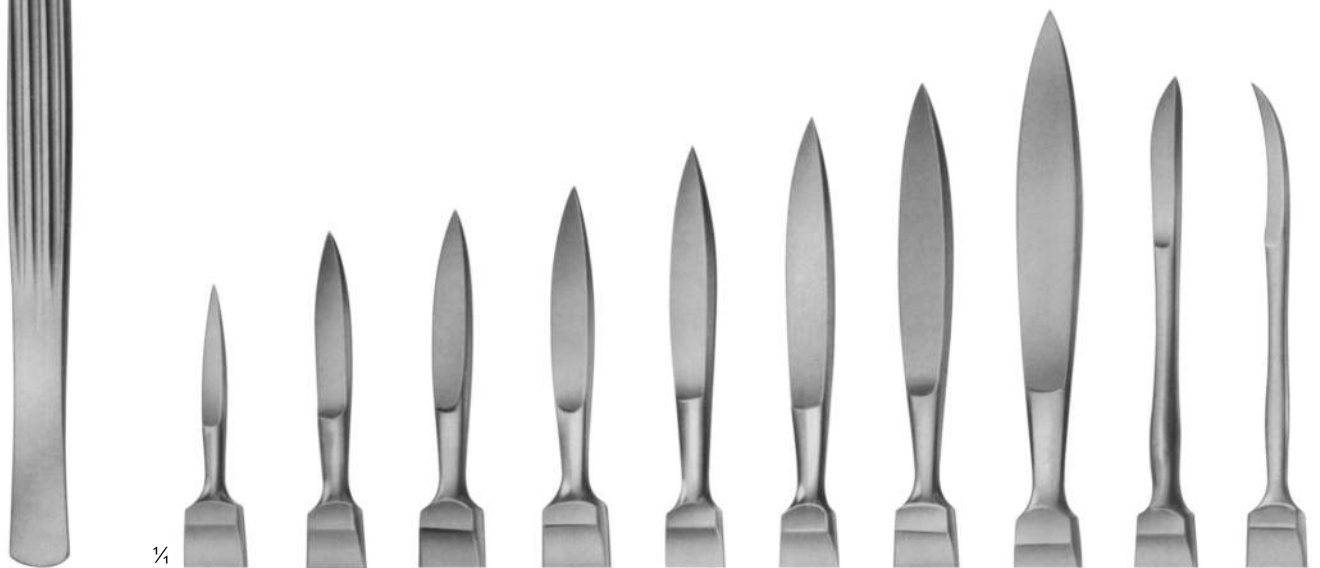

HP-04-032 HP-04-033 HP-04-034 HP-04-035 HP-04-036 HP-04-037 HP-04-038 HP-04-039 HP-04-040 HP-04-041
Tenotome

HP-04-022 - HP-04-041
14 cm - 17.5 cm

Cone Knives, Myomatome, Trigeminal, Tonsil Knives
Kegelmesser, Myomatome, Trigeminus, Tonsillenmesser
Facas Cone, Myomatome, Trigeminal, Facas Amígdalas
Cuchillos Cono, Myomatome, Trigeminal, Tonsil Knives

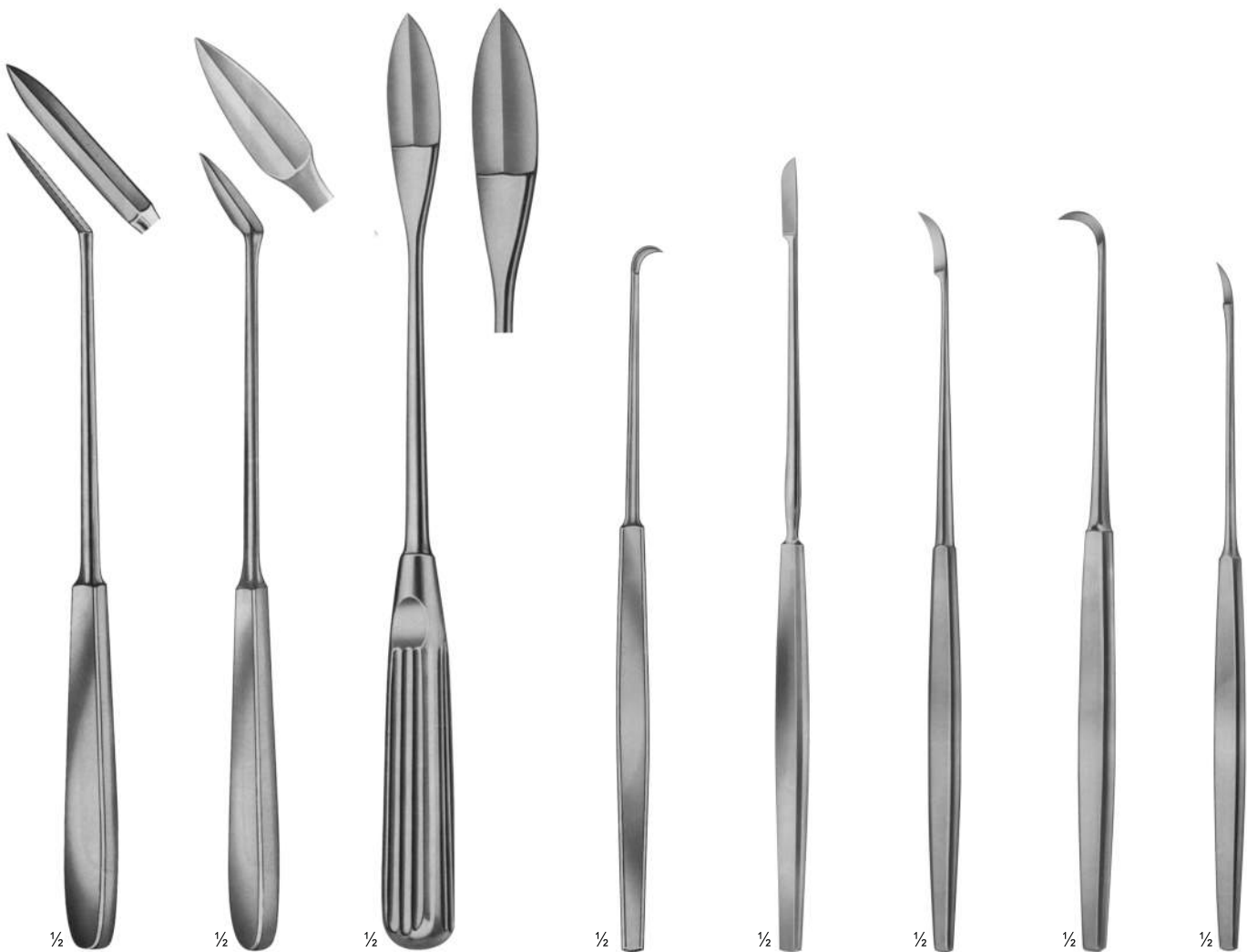

1/2

Ayre
HP-05-042
23.5 cm
Cone knife

1/2

HP-05-043
23 cm
Cone knife

1/2

Segond
HP-05-044
27 cm
Myomatome

1/2

Olivecrona
HP-05-045
20.5 cm
Trigeminal knife

1/2

HP-05-046
23 cm
Trigeminal knife

1/2

Abraham
HP-05-047
21.5 cm
Tonsil knife

1/2

Bruenings
HP-05-048
21.5 cm
Tonsil knife

1/2

Fowler
HP-05-049
20 cm
Tonsil knife

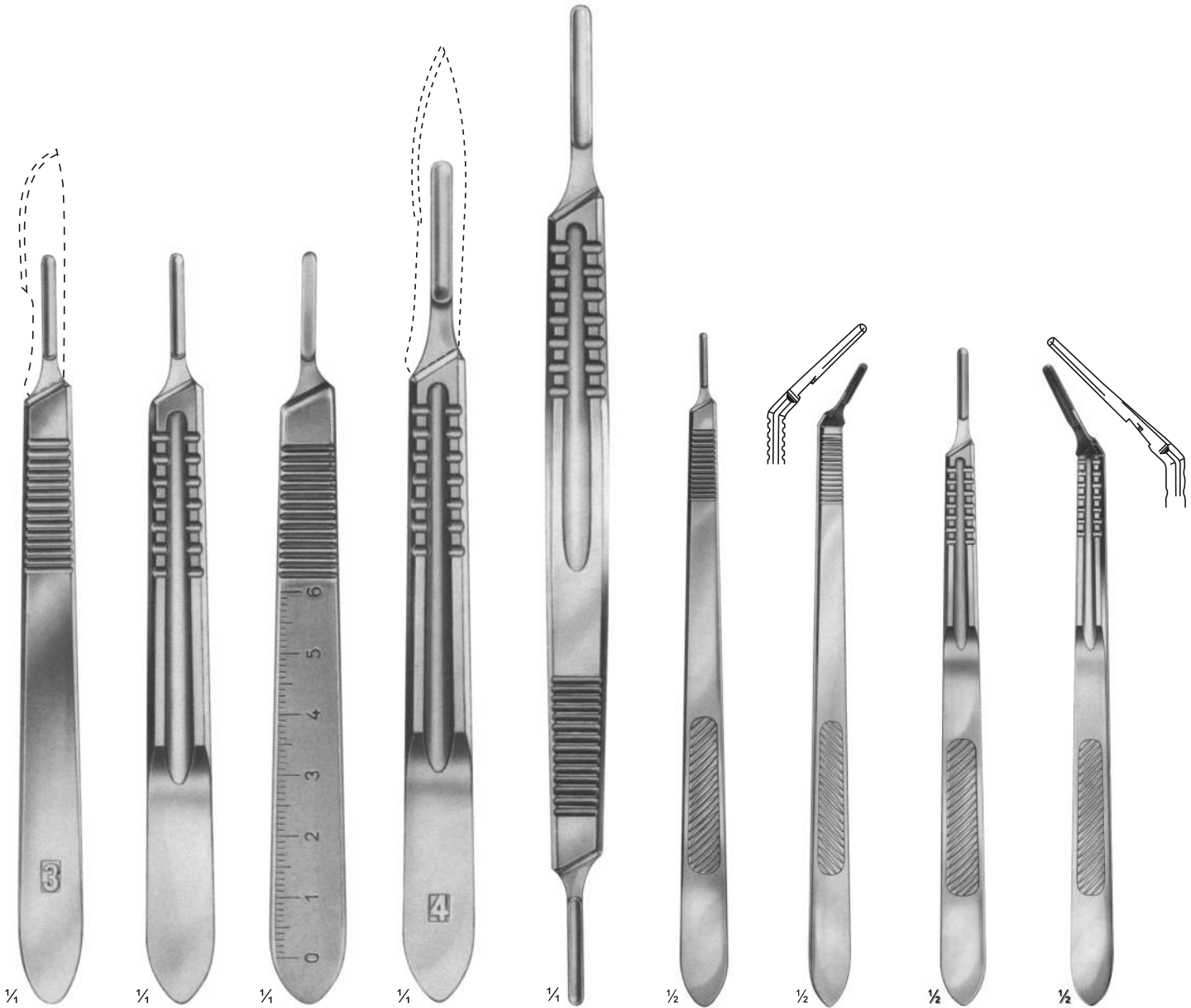

Standard
HP-06-050
No. 3
12 cm
Solid

HP-06-051
No. 3
12 cm
Solid

HP-06-052
No. 3
12 cm
Solid

Standard
HP-06-053
No. 4
13.5 cm
Solid

HP-06-054
Double handle
No. 4 + No. 3
16 cm
Solid

HP-06-055
No. 3 L
Straight
21.5 cm
Solid
Long

HP-06-056
No. 3 L
Angled
20.5 cm
Solid
Long

HP-06-057
No. 4 L
Straight
21 cm
Solid

HP-06-058
No. 4 L
20.5 cm
Solid angled



HP-07-059
No. 7
16 cm
Solid

HP-07-060
No. 7 K
12.5 cm
Solid

HP-07-061
No. 3
Hollow-Round
15.5 cm

HP-07-062
No. 3
Straight
14 cm
Solid

HP-07-063
No. 3
Angled
14 cm
Solid

Collin
HP-07-064
No. 8
13.5 cm
Hollow

Collin
HP-07-065
No. 9
14.5 cm
Hollow

Beaver
HP-07-066
No. 3K
11.5 cm

HP-07-067
No. 3KL
11.5 cm



Silver
HP-08-068
 19.5 cm
 For usual razor blades
 Dermatome



Schink
HP-08-069
 30 cm
 Adjustable from
 0.1 to 2.0 mm



Schink
HP-08-070
 Spare blade



Schink
HP-08-071
 Skin fixing plate

Dermatomes
Dermatome
Dermatomes
Dermatomas



Watson
HP-09-072
32 cm
Complete with blade



Humby
HP-09-073
32 cm
Complete with blade



Humby
HP-09-074
Spare blade



Scissors

Schere

Tesouras

tijeras

Page 12-52

Operating Scissors

Bedienungsscheren
Tesoura Operacional
Tijeras de operación



3/4

Standard
HP-12-001 - HP-12-007
14.5 cm
BL/BL



1/4

HP-12-001 12 cm
HP-12-002 13 cm
HP-12-003 14.5 cm
HP-12-004 16.5 cm
HP-12-005 18.5 cm
HP-12-006 20.5 cm
HP-12-007 25 cm



Straight

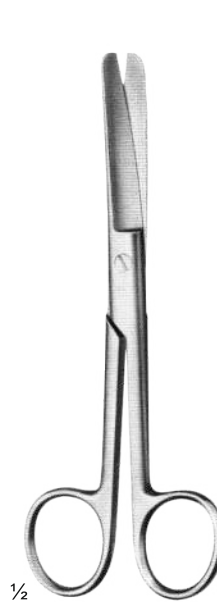

3/4

Standard
HP-12-008 - HP-12-014
14.5 cm
BL/BL



1/4

HP-12-008 12 cm
HP-12-009 13 cm
HP-12-010 14.5 cm
HP-12-011 16.5 cm
HP-12-012 18.5 cm
HP-12-013 20.5 cm
HP-12-014 25 cm



Curved



3/4

Standard
HP-12-015 - HP-12-021
14.5 cm
SH/BL



1/4

HP-12-015 12 cm
HP-12-016 13 cm
HP-12-017 14.5 cm
HP-12-018 16.5 cm
HP-12-019 18.5 cm
HP-12-020 20.5 cm
HP-12-021 25 cm



Straight

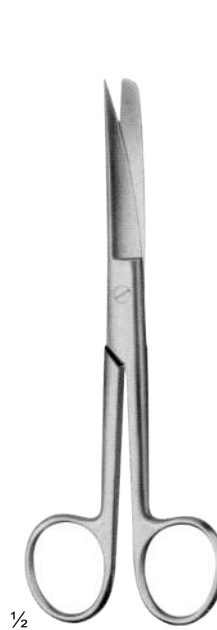

3/4

Standard
HP-12-022 - HP-12-028
14.5 cm
SH/BL



1/4

HP-12-022 12 cm
HP-12-023 13 cm
HP-12-024 14.5 cm
HP-12-025 16.5 cm
HP-12-026 18.5 cm
HP-12-027 20.5 cm
HP-12-028 25 cm



Curved

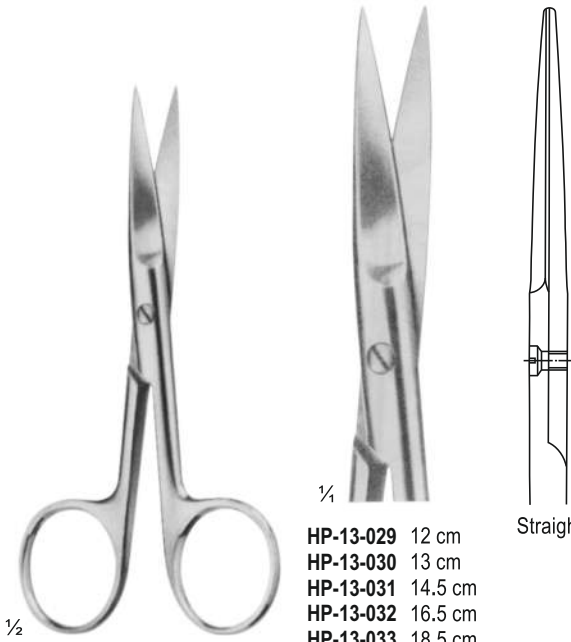

1/2

1/4

Straight

HP-13-029 12 cm
 HP-13-030 13 cm
 HP-13-031 14.5 cm
 HP-13-032 16.5 cm
 HP-13-033 18.5 cm
 HP-13-034 20.5 cm
 HP-13-035 25 cm

Standard
 HP-13-029 - HP-13-035
 14.5 cm
 SH/SH

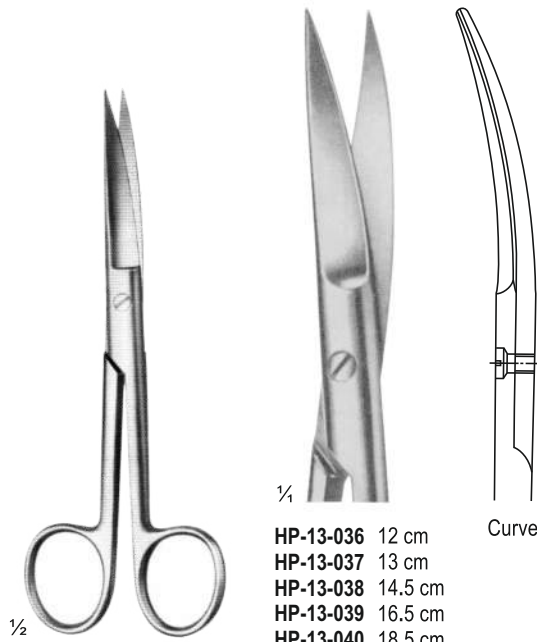

1/2

1/4

Curved

HP-13-036 12 cm
 HP-13-037 13 cm
 HP-13-038 14.5 cm
 HP-13-039 16.5 cm
 HP-13-040 18.5 cm
 HP-13-041 20.5 cm
 HP-13-042 25 cm

Standard
 HP-13-036 - HP-13-042
 14.5 cm
 SH/SH

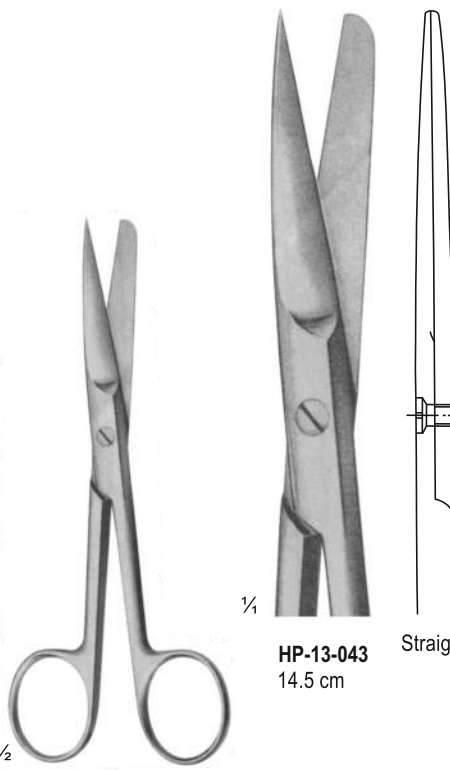

1/2

1/4

Straight

HP-13-043 14.5 cm

Deaver
 HP-13-043 - HP-13-044
 14.5 cm

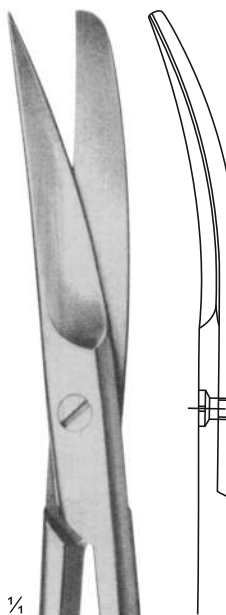

1/4

Curved

HP-13-044 14 cm

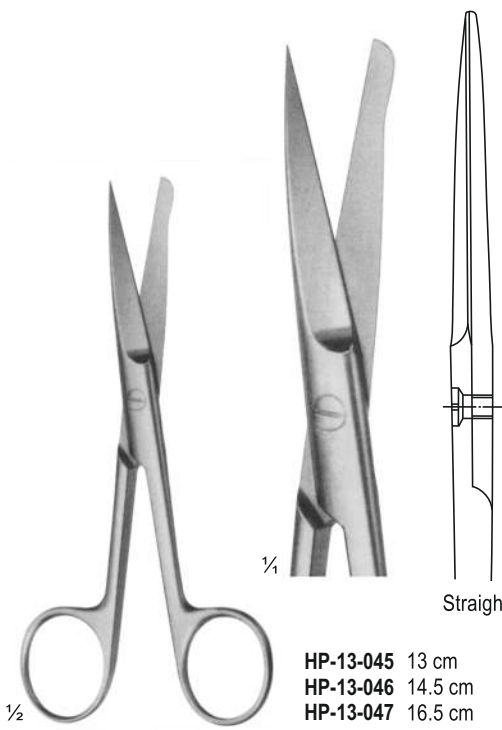

1/2

1/4

Straight

HP-13-045 13 cm
 HP-13-046 14.5 cm
 HP-13-047 16.5 cm

Incision Scissors
 HP-13-045 - HP-13-047
 14.5 cm

Dissecting Scissors
Präparierschere
Tesoura de dissecação
Tijeras de disección



Lexer
HP-14-048 - HP-14-050
16 cm

- HP-14-048 10 cm (Baby)
- HP-14-049 16 cm
- HP-14-050 21 cm

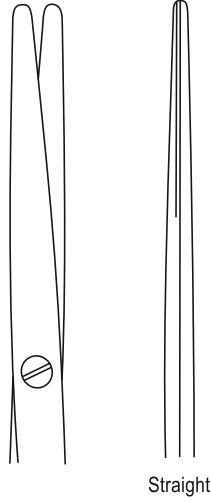

Straight



Lexer
HP-14-051 - HP-14-053
16 cm

- HP-14-051 10 cm (Baby)
- HP-14-052 16 cm
- HP-14-053 21 cm

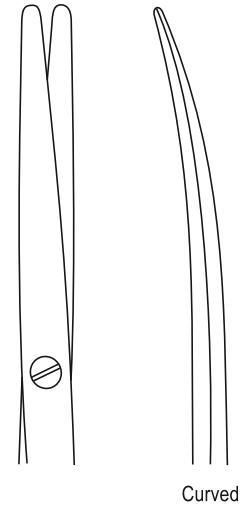

Curved

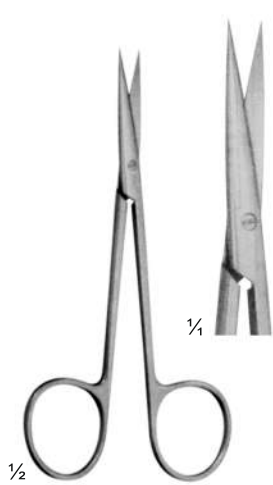

Kilner
HP-14-054
11.5 cm
Fine dissecting scissors

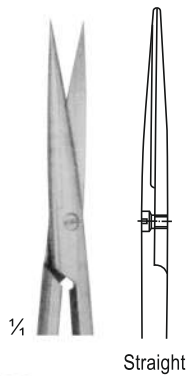

Straight

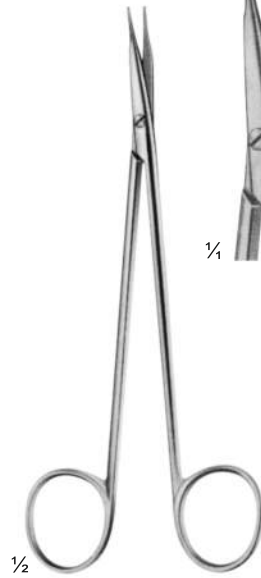

Jameson
HP-14-055
15 cm
Dissecting scissors

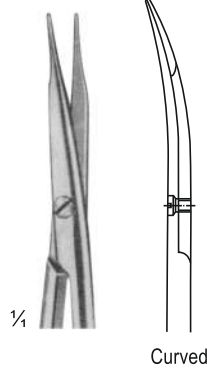

Straight

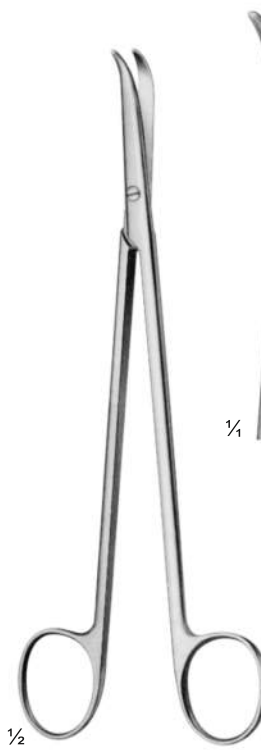

Thorek
HP-14-056
18.5 cm

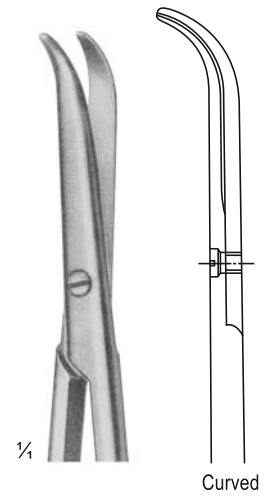

Curved

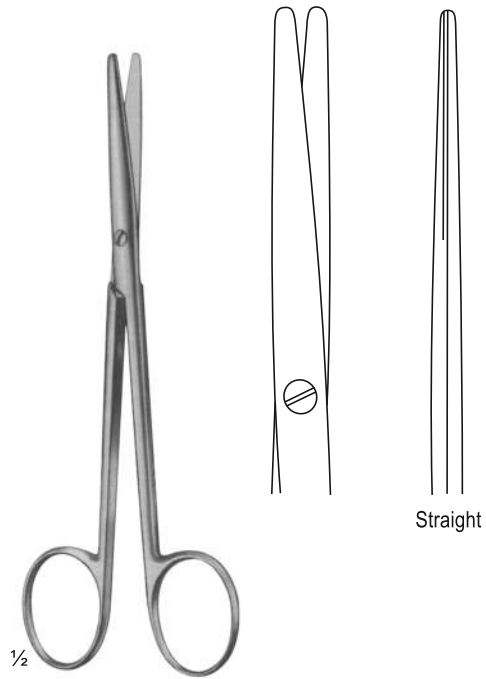

Lexer-Fine
HP-15-057
 16.5 cm
 Slender pattern

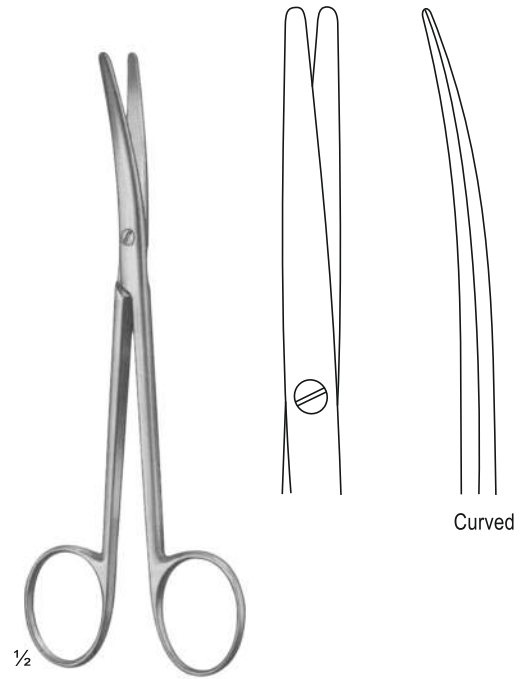

Lexer-Fine
HP-15-058
 16.5 cm
 Slender pattern

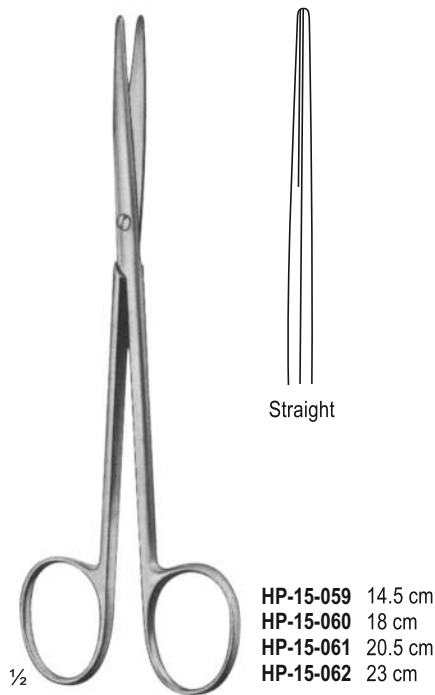

Metzenbaum-Fine
HP-15-062 - HP-15-062
 18 cm
 Slender pattern

- HP-15-059** 14.5 cm
- HP-15-060** 18 cm
- HP-15-061** 20.5 cm
- HP-15-062** 23 cm

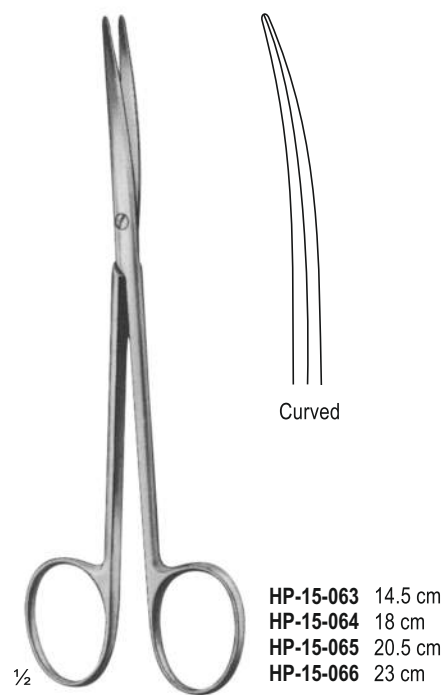

Metzenbaum-Fine
HP-15-063 - HP-15-066
 18 cm
 Slender pattern

- HP-15-063** 14.5 cm
- HP-15-064** 18 cm
- HP-15-065** 20.5 cm
- HP-15-066** 23 cm

Dissecting Scissors

Präparierschere
Tesoura de dissecação
Tijeras de disección

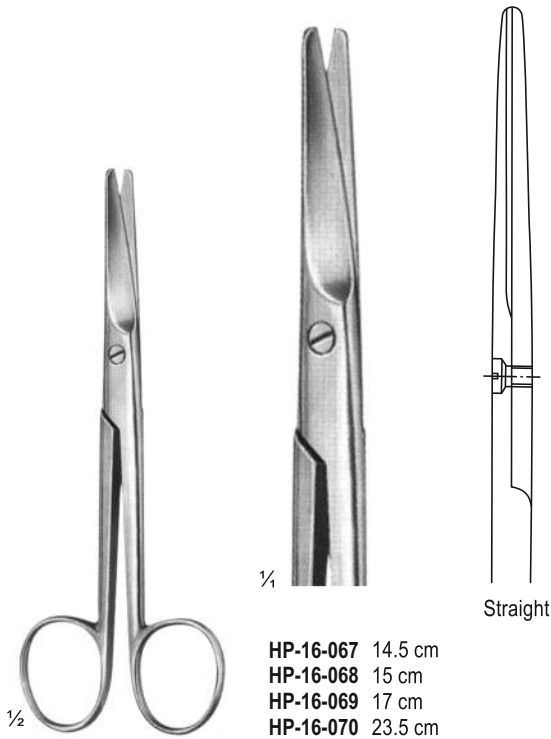

Mayo
HP-16-067 - HP-16-070
15 cm

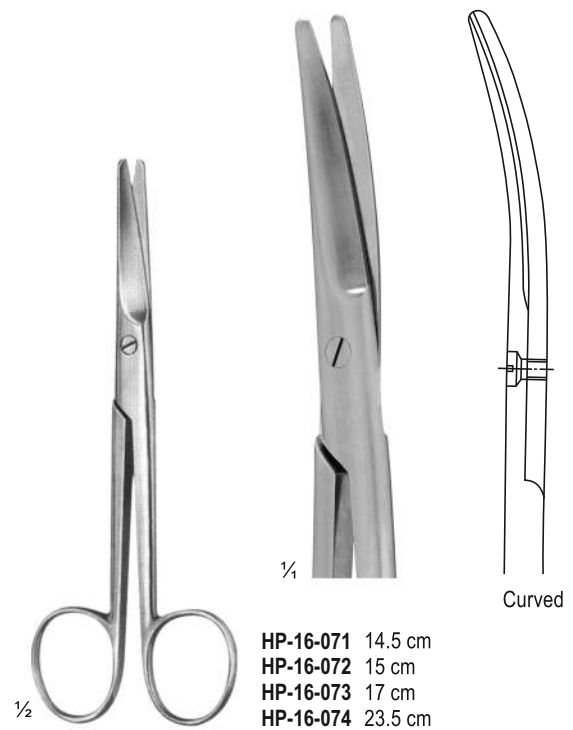

Mayo
HP-16-071 - HP-16-074
15 cm

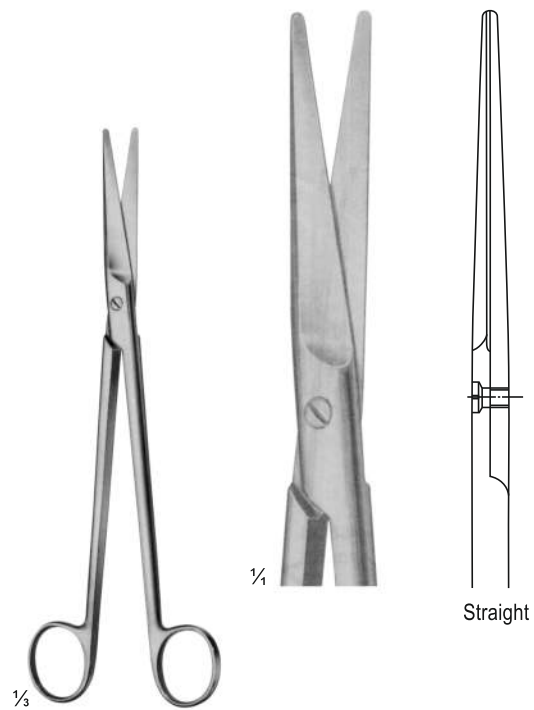

Mayo-Harrington
HP-16-075
23 cm

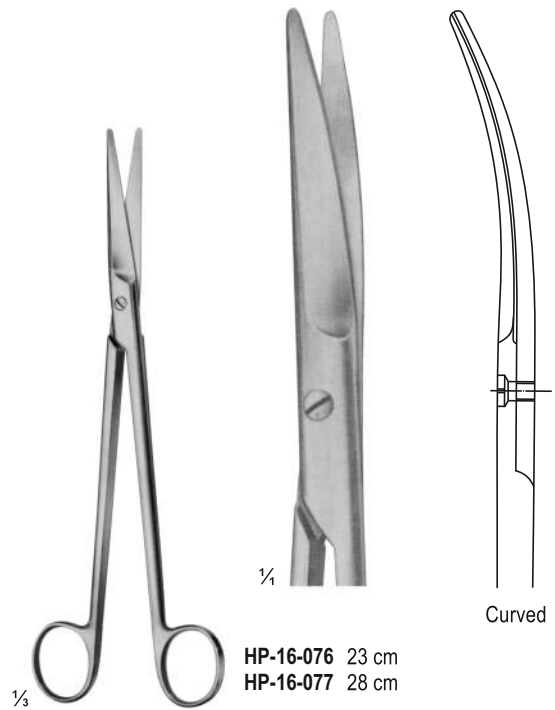

Mayo-Harrington
HP-16-076 - HP-16-077
23 cm

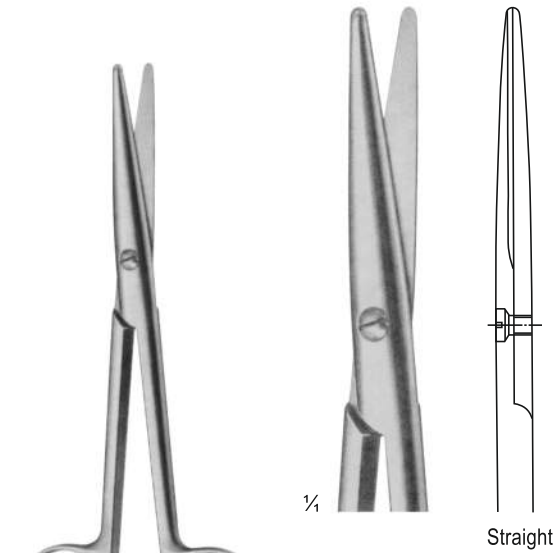

1/2
 Mayo-Stille
HP-17-078 - HP-17-081
 16 cm

1/4
HP-17-078 15 cm
HP-17-079 16 cm
HP-17-080 17 cm
HP-17-080 19.5 cm
HP-17-081 21.5 cm

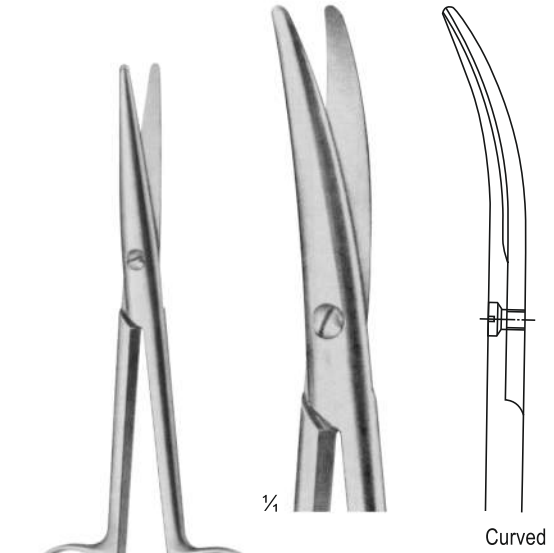

1/2
 Mayo-Stille
HP-17-082 - HP-17-086
 16 cm

1/4
HP-17-082 15 cm
HP-17-083 16 cm
HP-17-084 17 cm
HP-17-085 19.5 cm
HP-17-086 21.5 cm

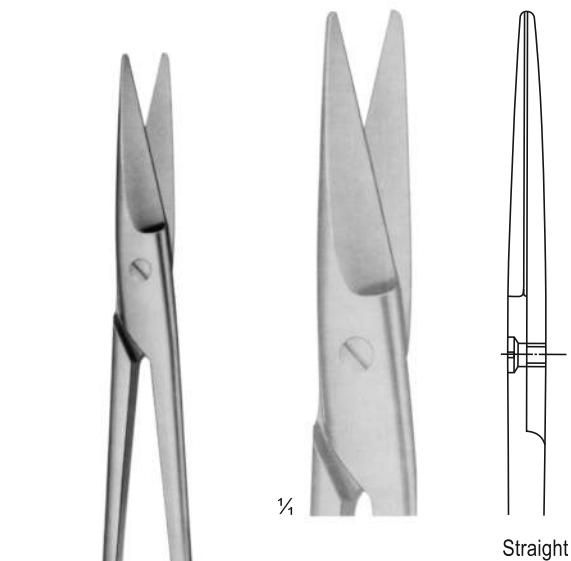

1/2
 Mayo-Noble
HP-17-087
 16.5 cm

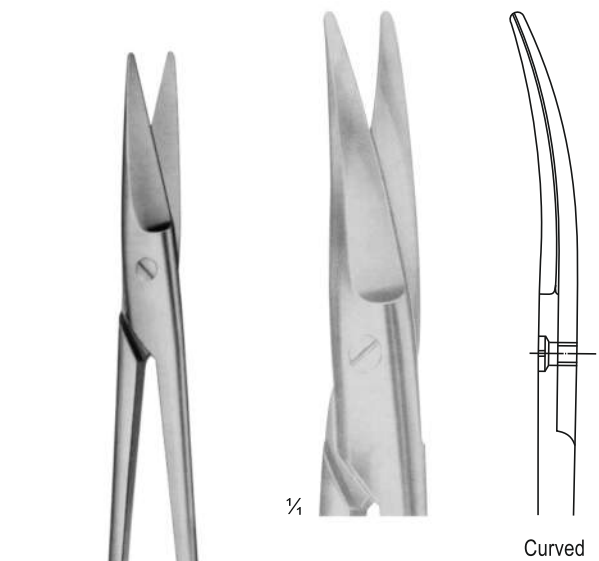

1/2
 Mayo-Noble
HP-17-088
 16.5 cm

Dissecting Scissors

Präparierschere
Tesoura de dissecação
Tijeras de disección

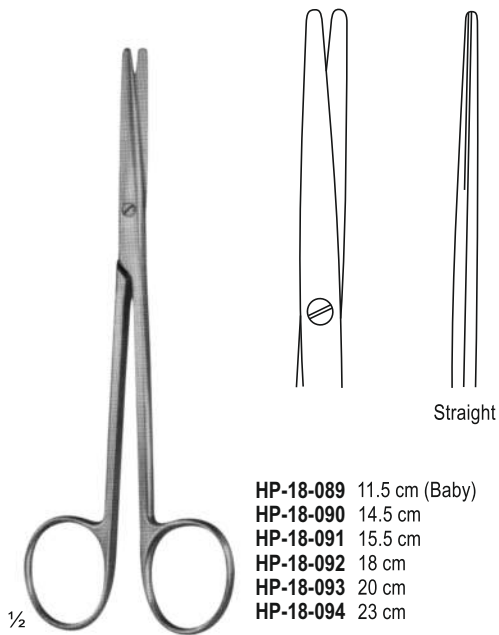

- HP-18-089 11.5 cm (Baby)
- HP-18-090 14.5 cm
- HP-18-091 15.5 cm
- HP-18-092 18 cm
- HP-18-093 20 cm
- HP-18-094 23 cm

Metzenbaum
HP-18-089 - HP-18-094
15.5 cm

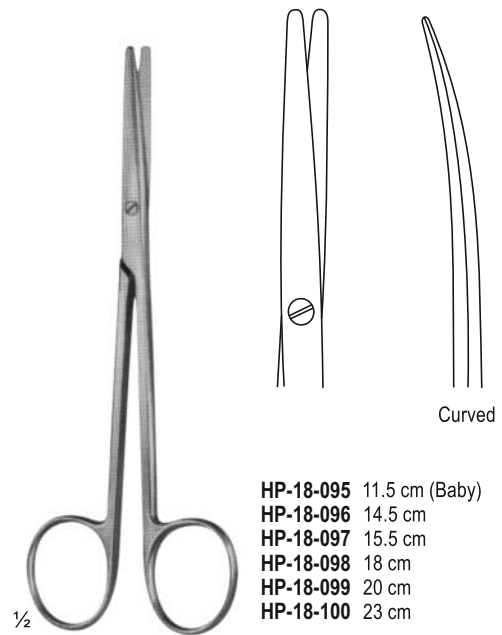

- HP-18-095 11.5 cm (Baby)
- HP-18-096 14.5 cm
- HP-18-097 15.5 cm
- HP-18-098 18 cm
- HP-18-099 20 cm
- HP-18-100 23 cm

Metzenbaum
HP-18-095 - HP-18-100
15.5 cm

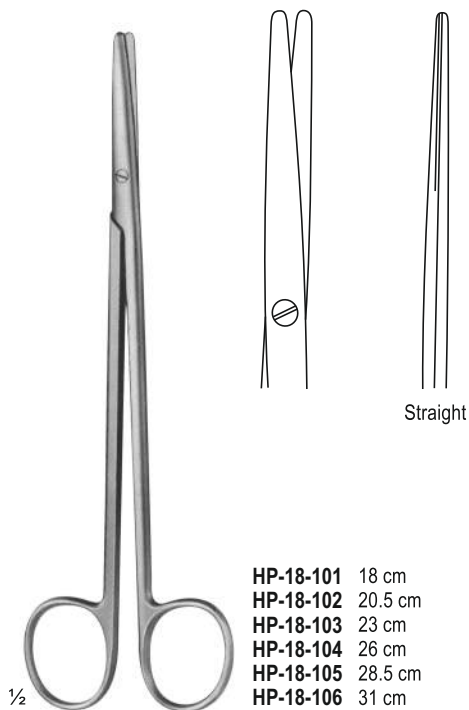

- HP-18-101 18 cm
- HP-18-102 20.5 cm
- HP-18-103 23 cm
- HP-18-104 26 cm
- HP-18-105 28.5 cm
- HP-18-106 31 cm

Metzenbaum-Nelson
HP-18-101 - HP-18-106
18 cm

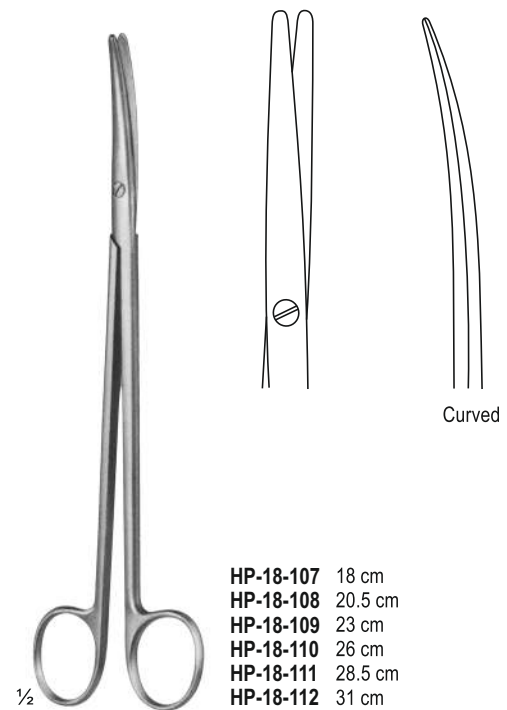

- HP-18-107 18 cm
- HP-18-108 20.5 cm
- HP-18-109 23 cm
- HP-18-110 26 cm
- HP-18-111 28.5 cm
- HP-18-112 31 cm

Metzenbaum-Nelson
HP-18-107 - HP-18-112
18 cm

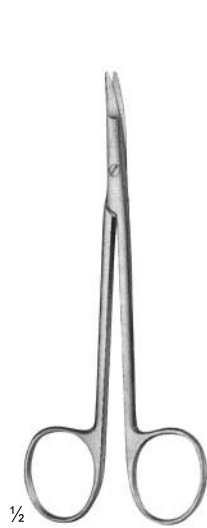

Shea Vein Graft
HP-19-113
 12 cm

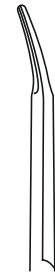

Curved



HP-19-114
 13 cm
 Dissecting Scissors



Curved

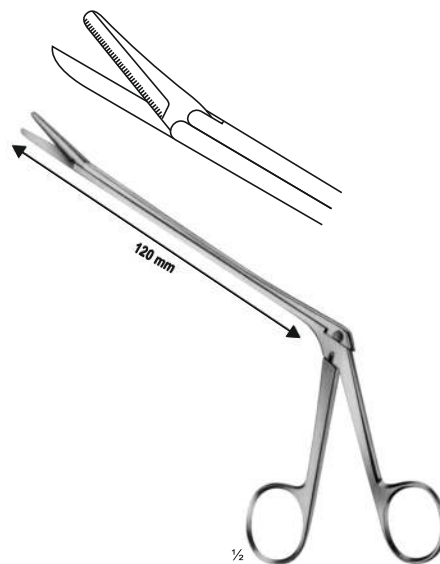

Olivecrona
HP-19-115
 12 cm
 Trigeminal Scissors

Dissecting Scissors, Iris Scissors, Operating Scissors
 Präparierscheren, Irisscheren, Operationsscheren
 Tesoura de dissecação, tesoura de íris, tesoura de funcionamento
 Tijeras de disección, tijeras de iris, tijeras de operación

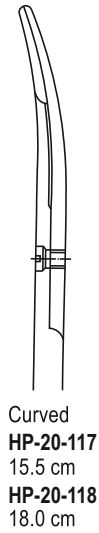
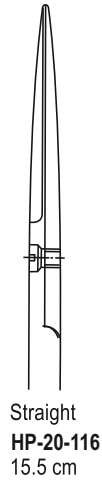

Reynolds
HP-20-116 - HP-20-118
 15.5 cm
 Dissecting scissors

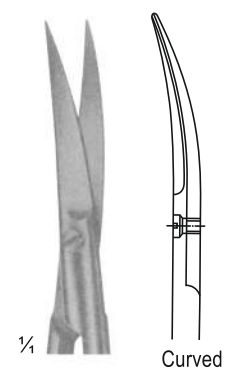
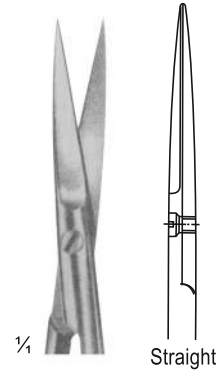
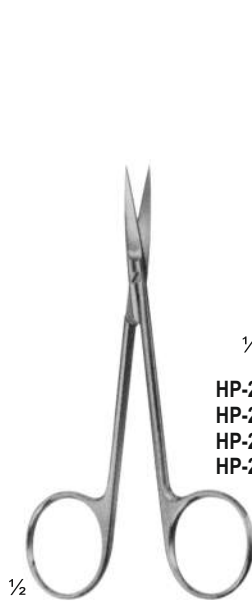

HP-20-119 9 cm
HP-20-120 10 cm
HP-20-121 11.5 cm
HP-20-122 12.5 cm

HP-20-123 9 cm
HP-20-124 10 cm
HP-20-125 11.5 cm
HP-20-126 12.5 cm

Iris
HP-20-119 - HP-20-126
 11.5 cm

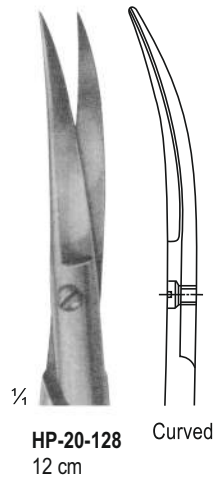
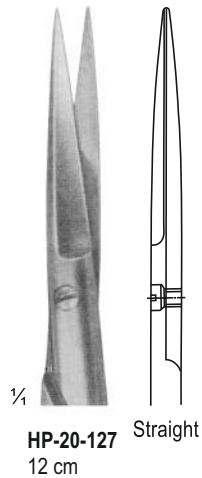

Wagner
HP-20-127 - HP-20-128
 Operating scissors

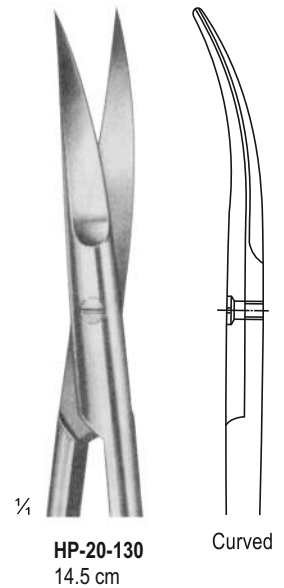
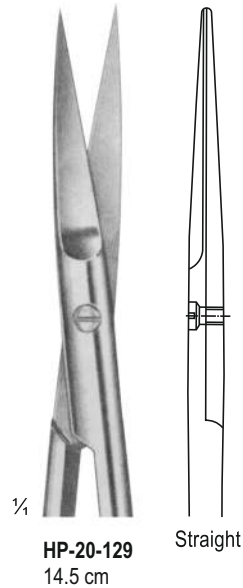

Joseph
HP-20-129 - HP-20-130
 Operating scissors

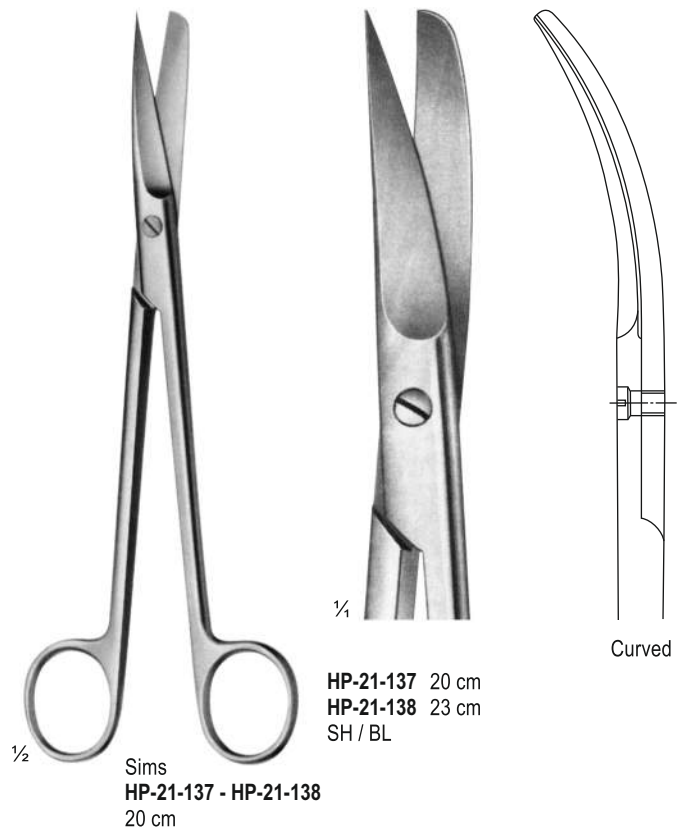
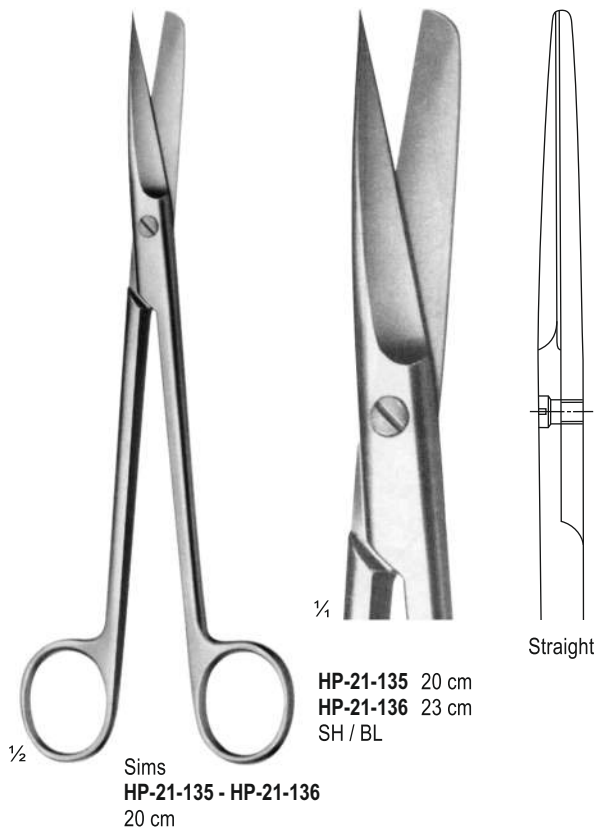
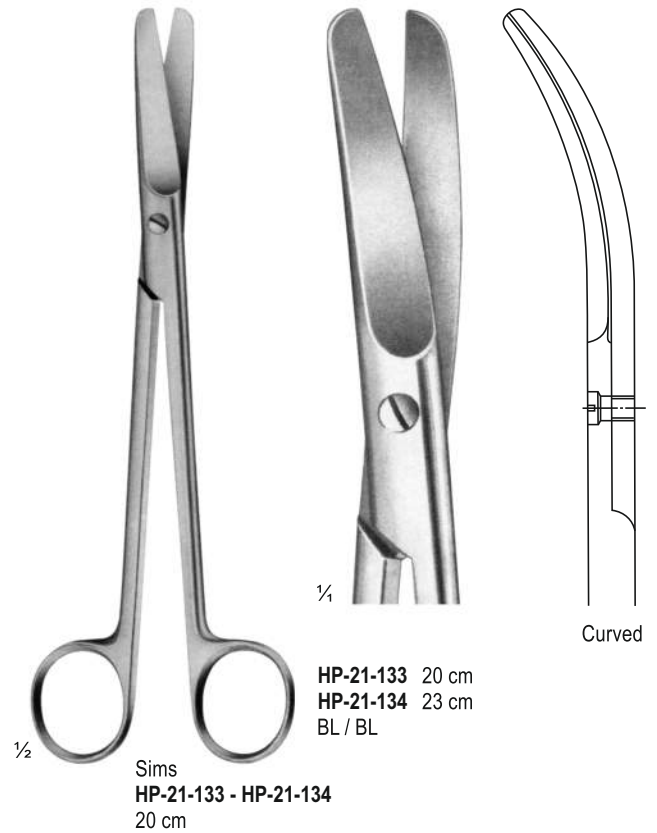
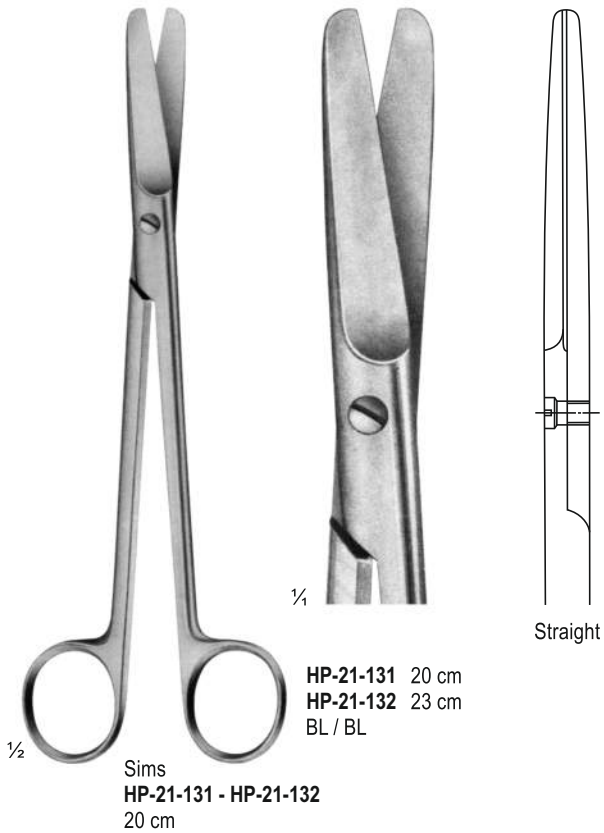

Gynecology Scissors
Gynäkologische Schere
Tesoura de Ginecologia
Tijeras para ginecología

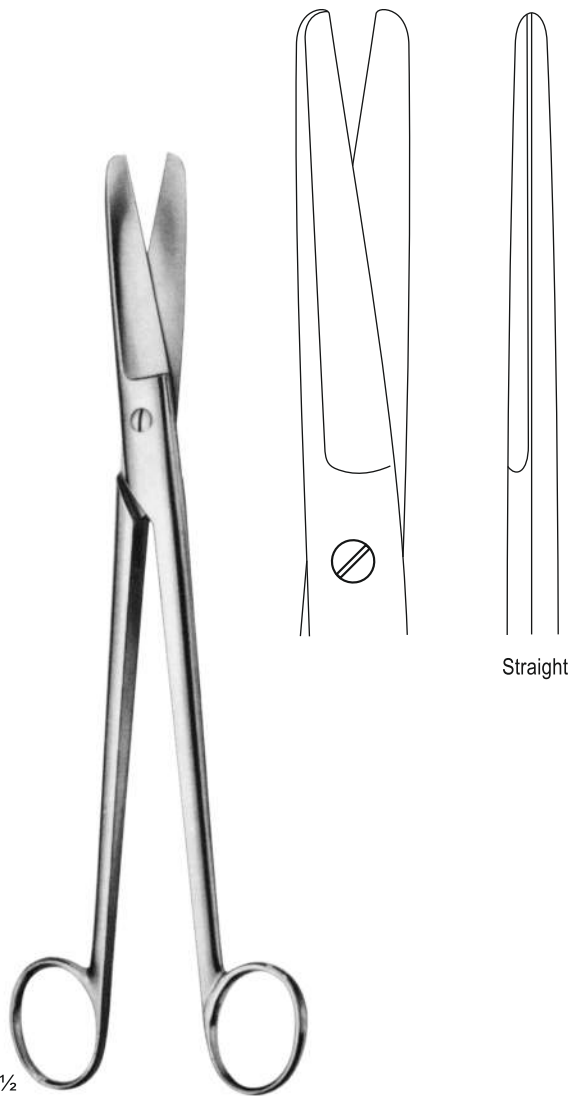

Straight

Sims-Siebold
HP-22-139
24.5 cm

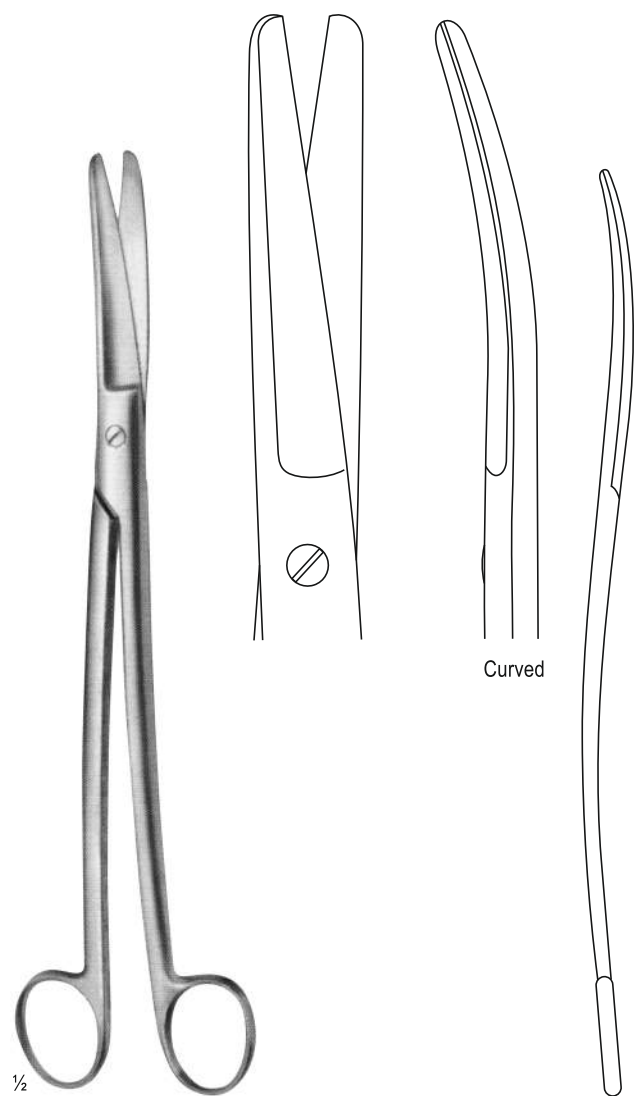

Curved

Sims-Siebold
HP-22-140
24.5 cm



1/2

Doyen
HP-23-141
 18.5 cm

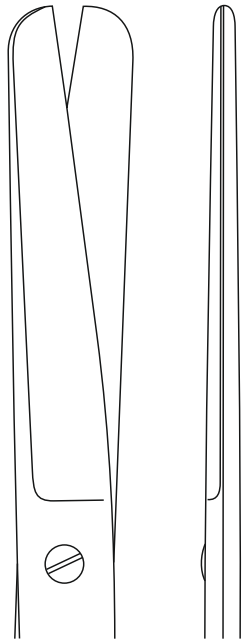

Straight



1/2

Doyen
HP-23-142
 18.5 cm

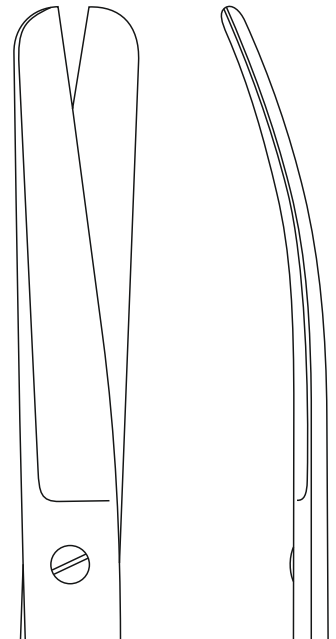

Curved



1/2

Wertheim
HP-23-143 - HP-23-145
 20 cm

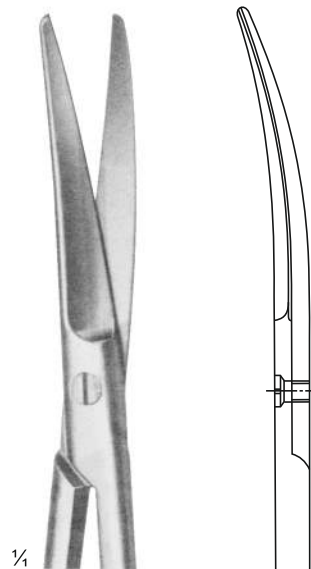

Curved

1/4

HP-23-143 14.5 cm
HP-23-144 20 cm
HP-23-145 23 cm

Face-lift Scissors
Face-Lift-Schere
Tesoura de Face-lift
Tijeras de estiramiento facial



1/2

Kaye
HP-24-146
18.5 cm
One toothed cutting edge

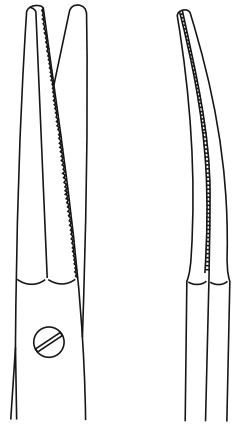

Curved



1/2

Aston
HP-24-147
17 cm
One toothed cutting edge

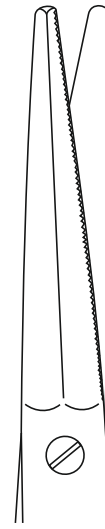

Straight



1/2

Gorney
HP-24-148 - HP-24-150
12.5 cm
One toothed cutting edge

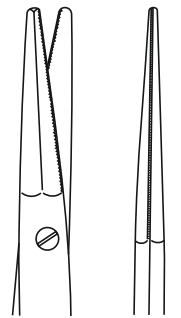

Straight

HP-24-148
12.5 cm
HP-24-149
19.5 cm

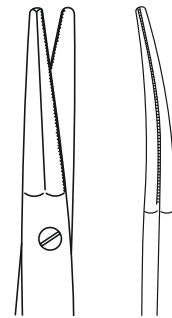

Curved

HP-24-150
19.5 cm



Peck-Joseph
HP-25-151 - HP-25-152
 Sharp

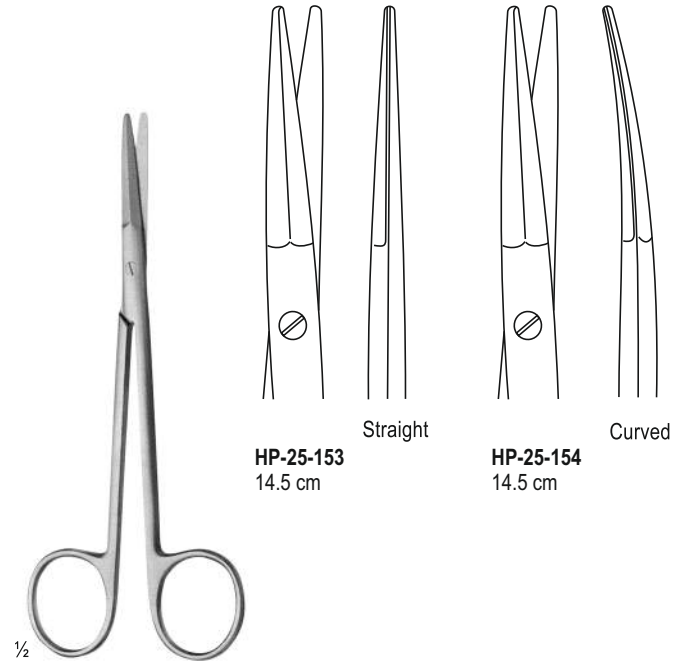
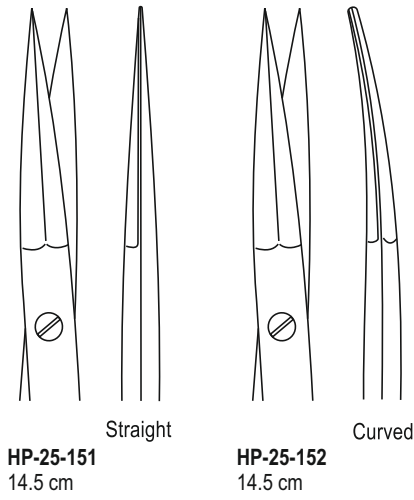

Peck-Joseph
HP-25-153 - HP-25-154
 Blunt

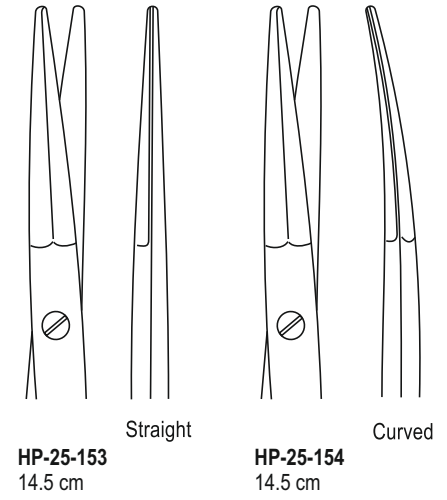

Kilner
HP-25-155 - HP-25-156
 12 cm
 Dissecting scissors
 special flat points for dissecting
 and undermining the skin

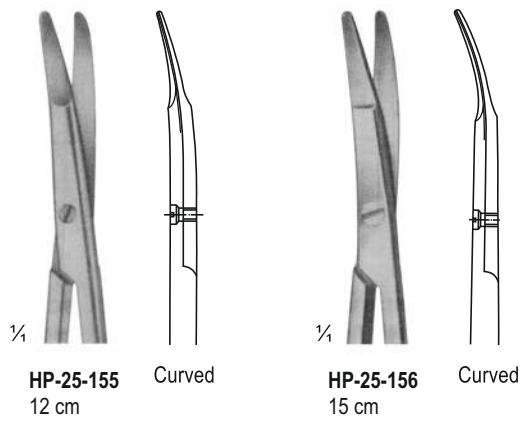



HP-26-157
Blunt

HP-26-158
Sharp

Converse
HP-26-157 - HP-26-158
10.5 cm

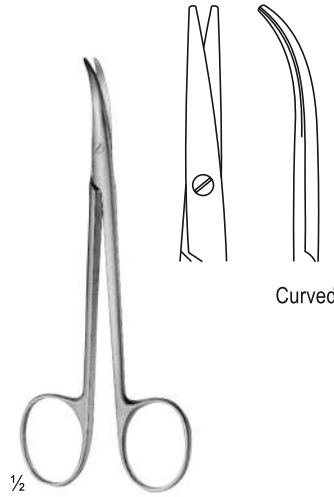

Curved

Cinelli
HP-26-159
11.5 cm

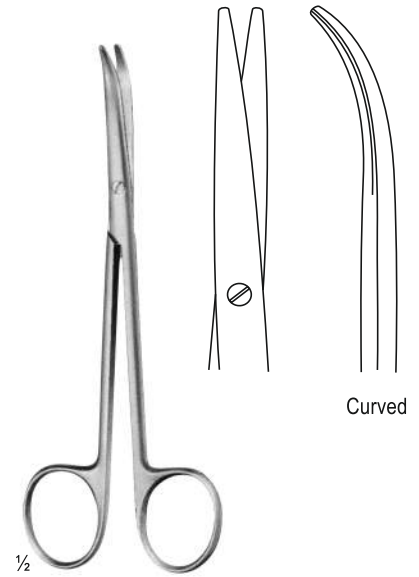

Curved

Cinelli
HP-26-160
14 cm

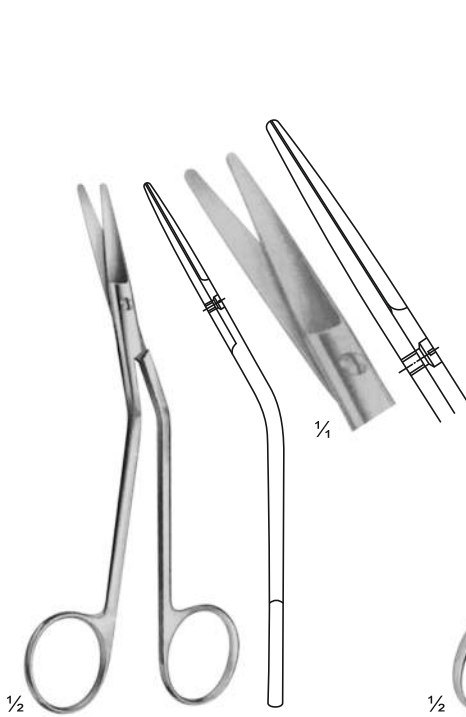

Fomon
HP-26-161
Blades serrated
14 cm

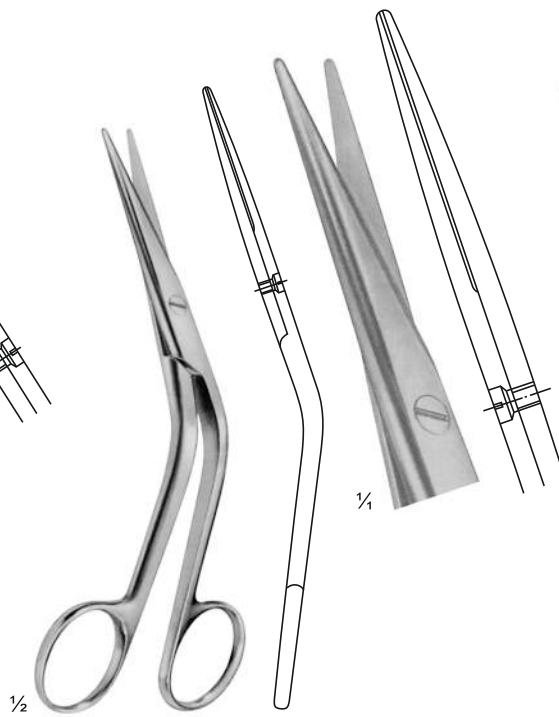

Cottle
HP-26-162
15.5 cm

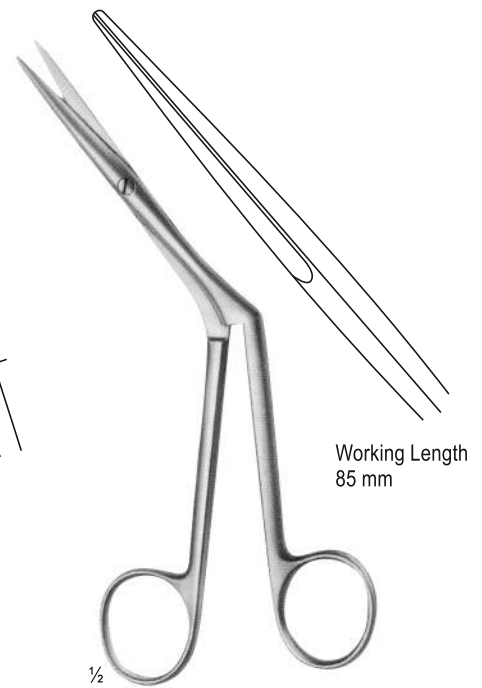

Working Length
85 mm

Heymann
HP-26-163
18.5 cm

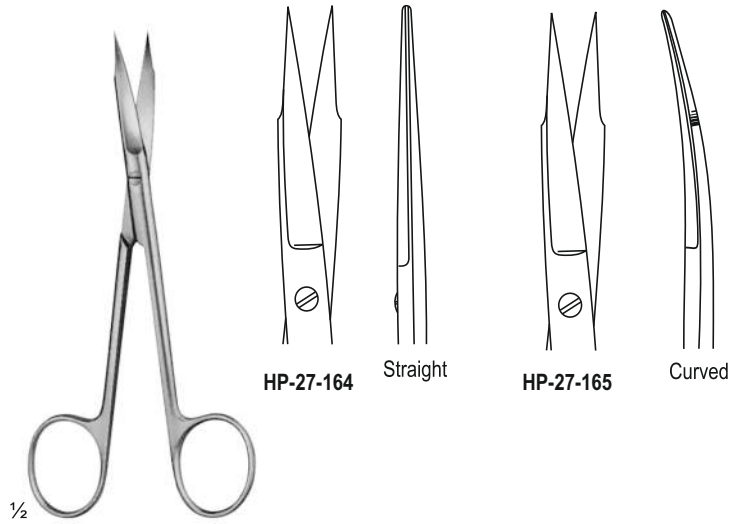

Goldman-Fox
HP-27-164 - HP-27-165
13 cm
One toothed cutting edge

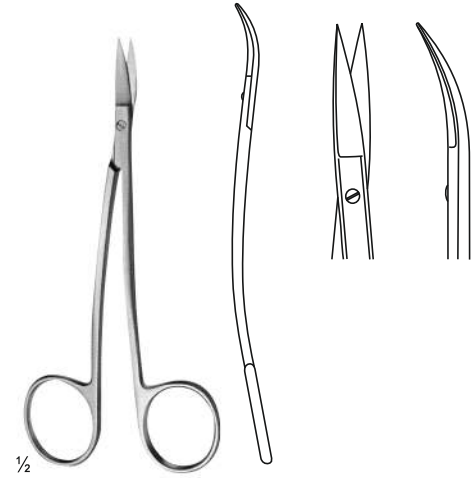

La Grange
HP-27-166
11.5 cm
S-shape

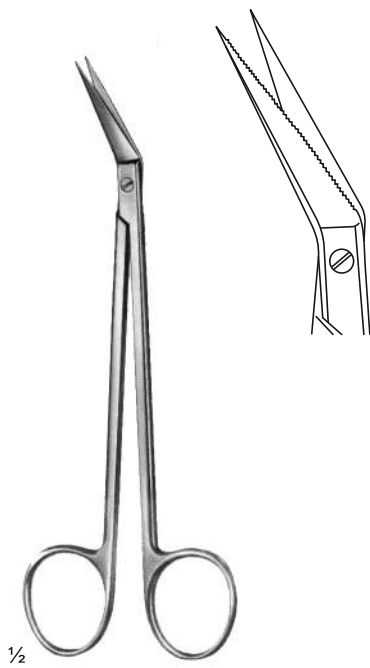

Locklin
HP-27-167
16 cm
One toothed cutting edge

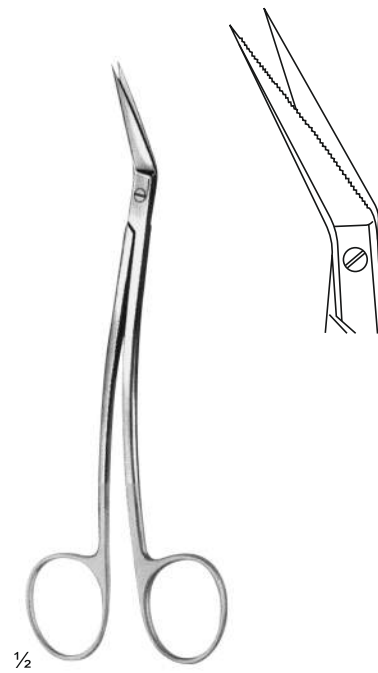

Locklin
HP-27-168
16 cm
S-shape
One toothed cutting edge

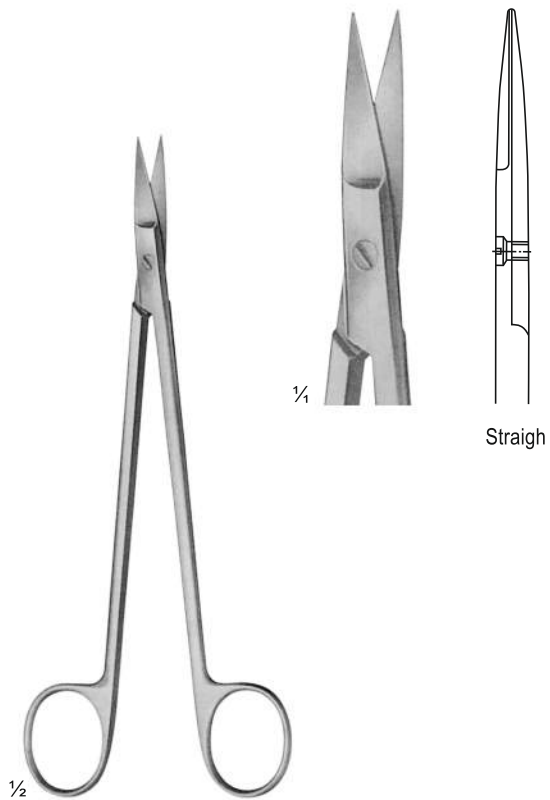

Kelly
HP-28-169
16 cm

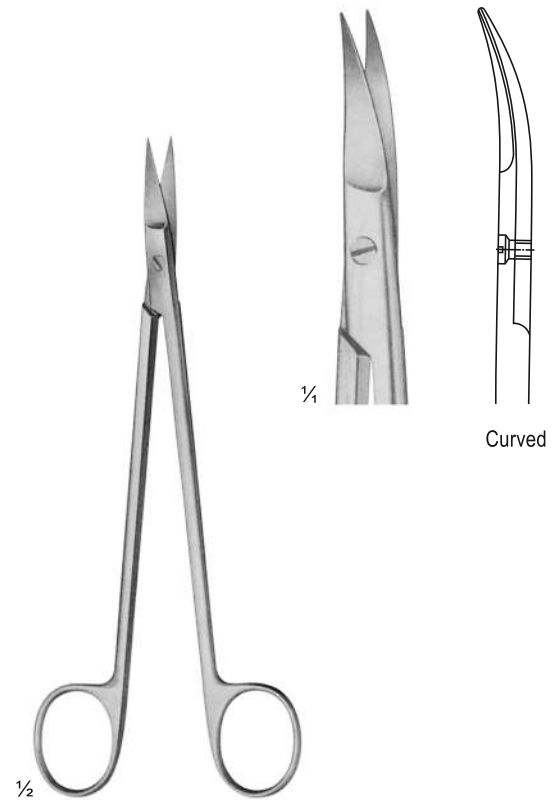

Kelly
HP-28-170
16 cm



1/2

Diethrich
HP-29-171 - HP-29-175
 17.5 cm



HP-29-171
 19 cm
 25°



HP-29-172
 18.5 cm
 45°

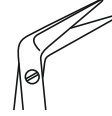

HP-29-173
 17.5 cm
 60°



HP-29-174
 17.5 cm
 90°



HP-29-175
 17.5 cm
 120°



1/2

Micro-Hegemann
HP-29-176 - HP-29-180
 18.5 cm



HP-29-176
 25°

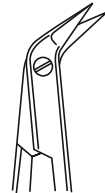

HP-29-177
 45°

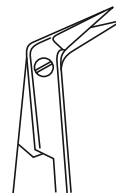

HP-29-178
 60°



HP-29-179
 90°

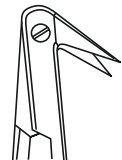

HP-29-180
 120°



Vascular Scissors
Gefäßscheren
Tesoura Vascular
Tijeras vasculares



1/2

Potts-Smith
HP-30-181 - HP-30-184
19 cm

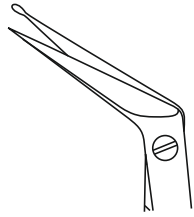

HP-30-181
60°

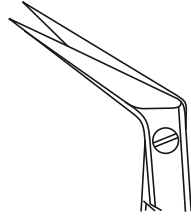

HP-30-182
60°

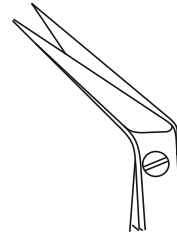

HP-30-183
40°



HP-30-184
25°



1/2

DeBakey
HP-30-185 - HP-30-186
16 cm

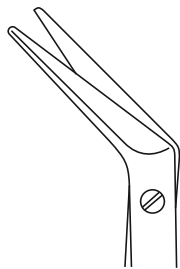

HP-30-185
45°

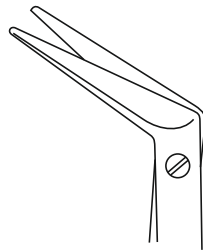

HP-30-186
60°



HP-31-187 - HP-31-196



25°



45°

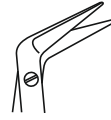

60°

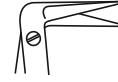

90°



125°

	Material	25°	45°	60°	90°	125°
	W	10 mm	10 mm	10 mm	10 mm	10 mm
18 cm	St	HP-31-187	HP-31-188	HP-31-189	HP-31-190	HP-31-191
18 cm	Ti	HP-31-192	HP-31-193	HP-31-194	HP-31-195	HP-31-196



HP-31-207 - HP-31-206



25°



45°



60°



90°



125°

	Material	25°	45°	60°	90°	125°
	W	7 mm	7 mm	7 mm	7 mm	7 mm
18 cm	St	HP-31-197	HP-31-198	HP-31-199	HP-31-200	HP-31-201
18 cm	Ti	HP-31-202	HP-31-203	HP-31-204	HP-31-205	HP-31-206

Vascular Scissors
Gefäßscheren
Tesoura Vascular
Tijeras vasculares

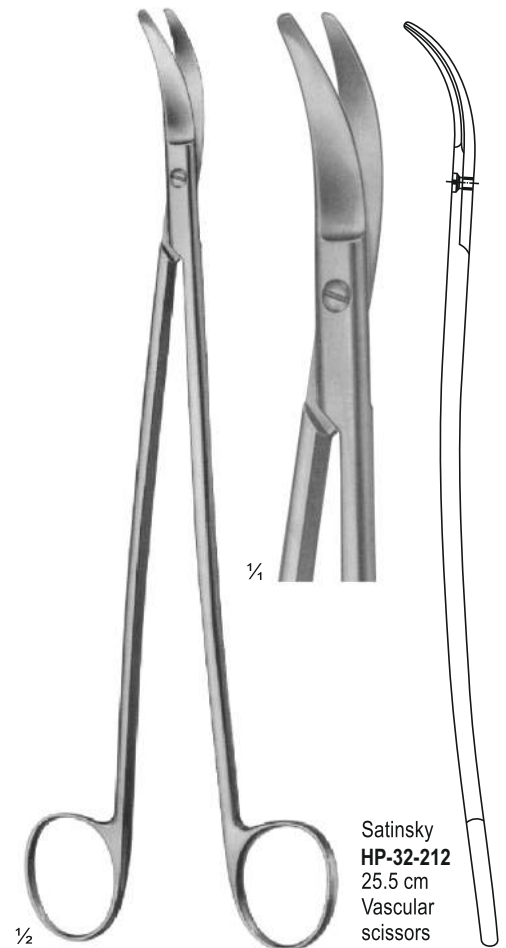
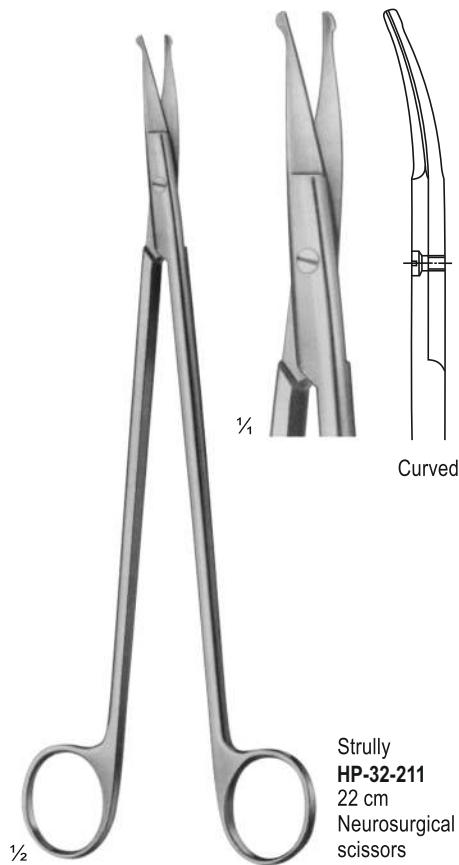
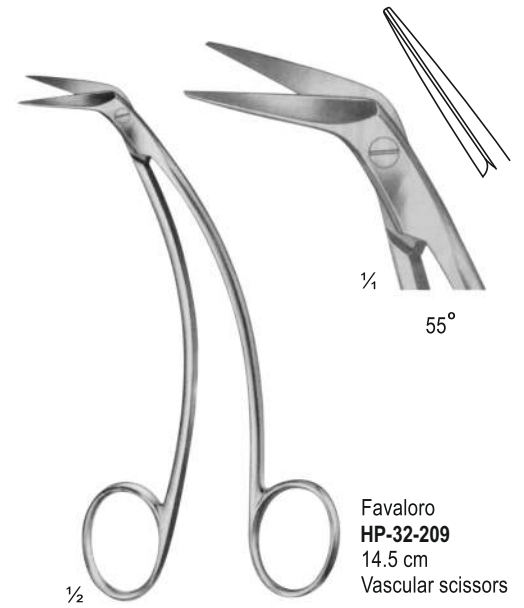
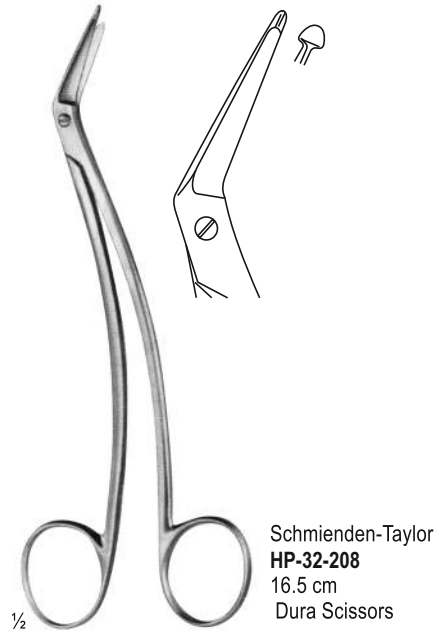

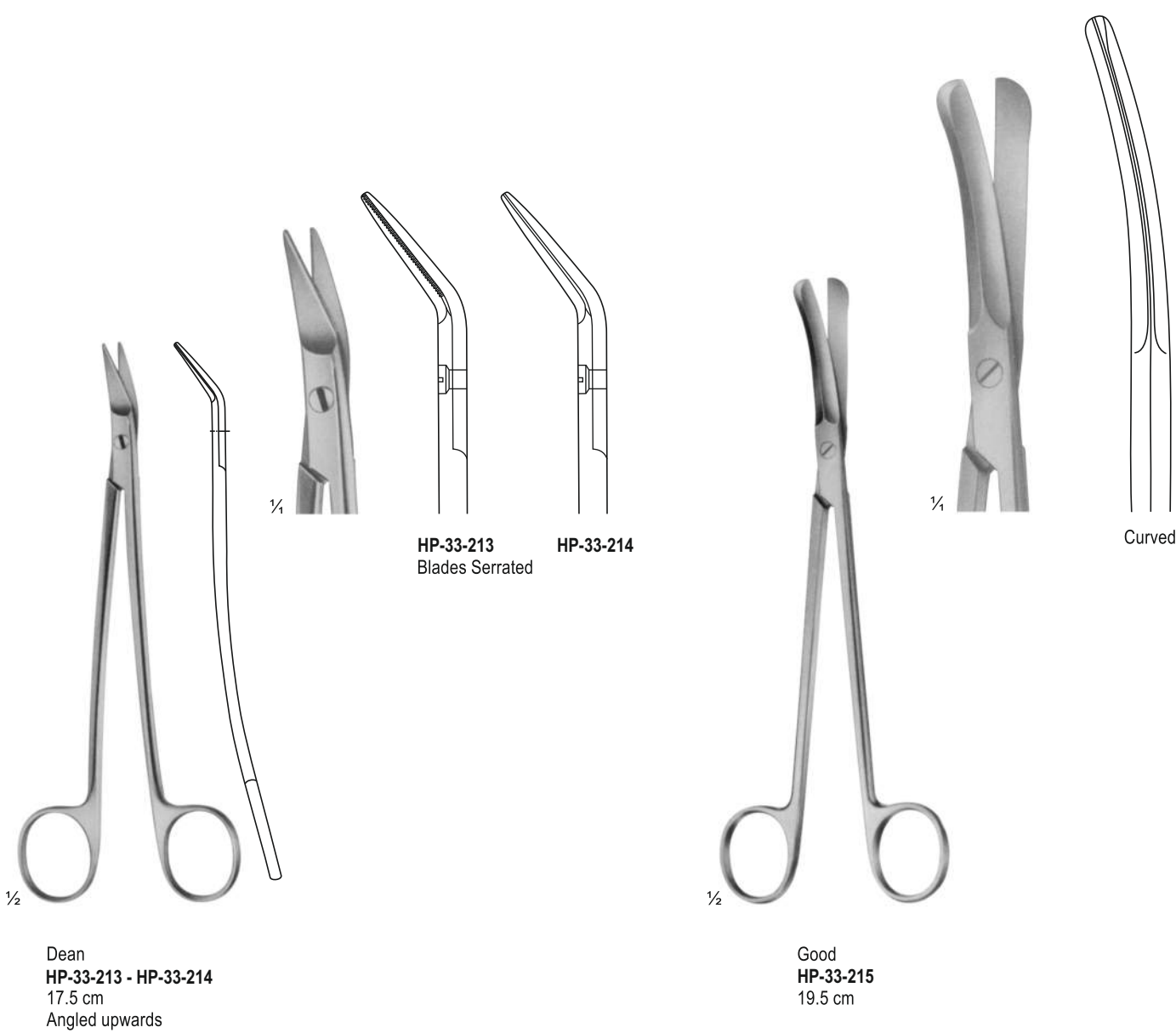

1/2
Dean
HP-33-213 - HP-33-214
17.5 cm
Angled upwards

HP-33-213
Blades Serrated

HP-33-214

1/2
Good
HP-33-215
19.5 cm

Curved

Episiotomy Scissors, Umbilical Scissors

Dammschnittschere, Nabelschnurschere
Tesoura de episiotomia, Tesoura Umbilical
Tijeras de episiotomía, tijeras umbilicales



1/2
Braun-Stadler
HP-34-216 - HP-34-217
HP-34-216 14.5 cm
HP-34-217 22 cm
Episiotomy scissors

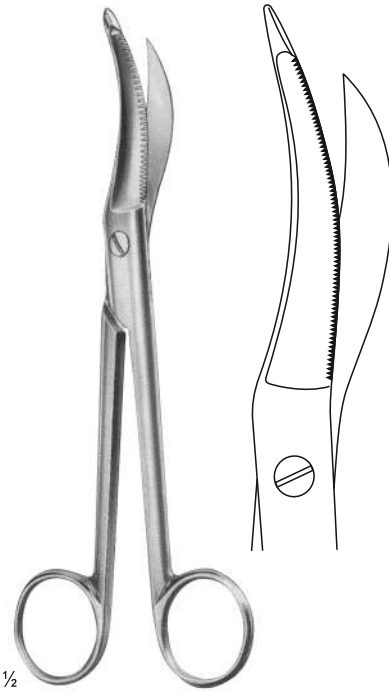

1/2
Waldmann
HP-34-218
18 cm
Episiotomy scissors
one toothed cutting edge

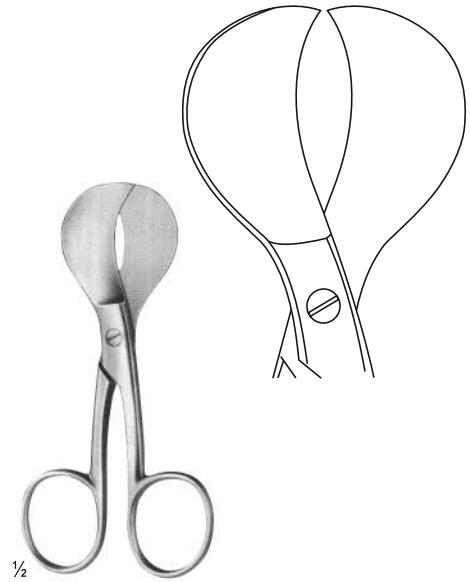

1/2
Mod. USA
HP-34-219 - HP-34-221
HP-34-219 10.5 cm
HP-34-220 12.5 cm
HP-34-221 15 cm
Umbilical scissors

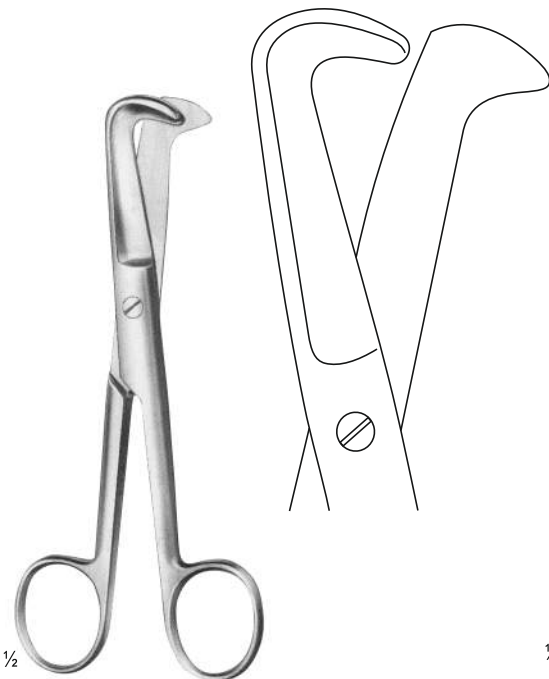

1/2
Schuhmacher
HP-34-222
15.5 cm
Umbilical scissors



1/2
Busch
HP-34-223 - HP-34-224
16 cm
Umbilical scissors



HP-34-223

Laterally curved

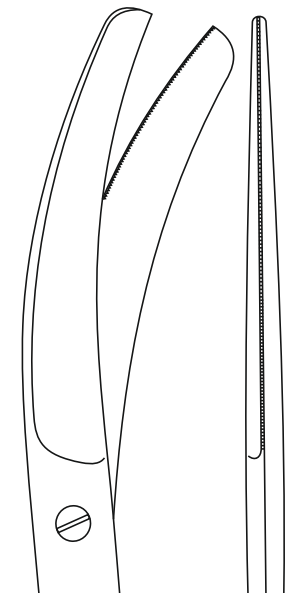

HP-34-224

One toothed cutting edge

Laterally curved



1/2

Stevens
 HP-35-225 - HP-35-228
 11 cm
 Vessel and tendon Scissors

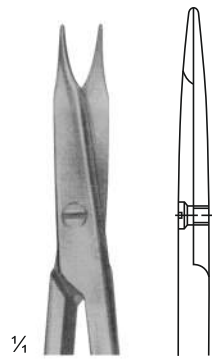

1/4

HP-35-225
 Sharp

Straight

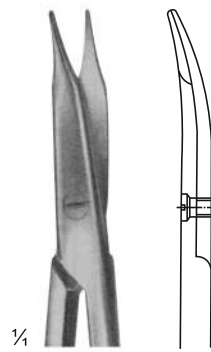

1/4

HP-35-226
 Sharp

Curved

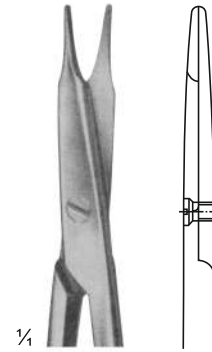

1/4

HP-35-227
 Blunt

Straight

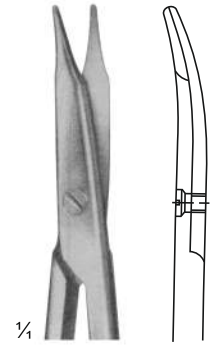

1/4

HP-35-228
 Blunt

Curved

Stitch Scissors, Ligature Scissors

Stichschere, Ligaturschere
Tesoura De Ponto, Tesoura Ligadura
Stitch Scissors, Ligature Scissors

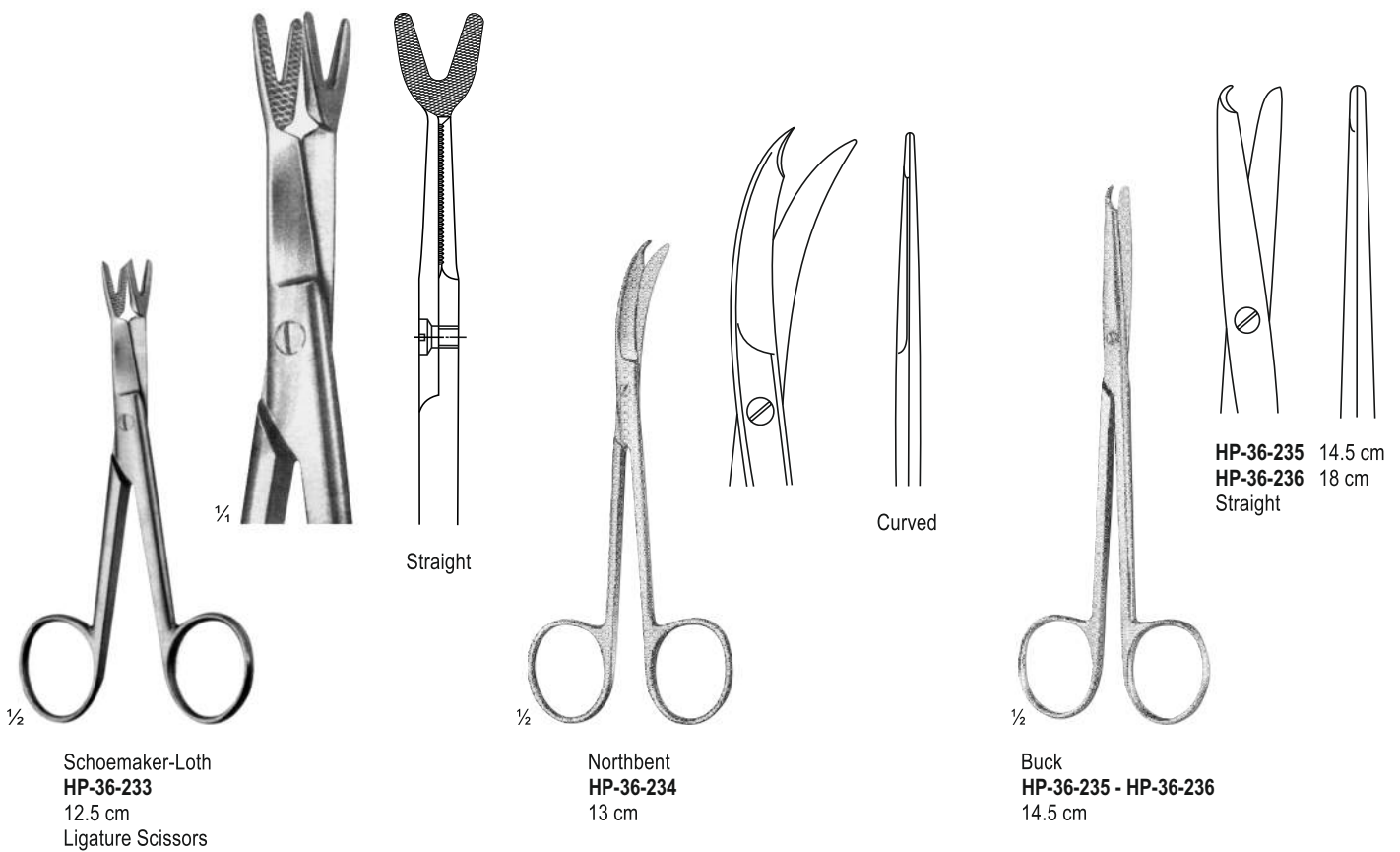
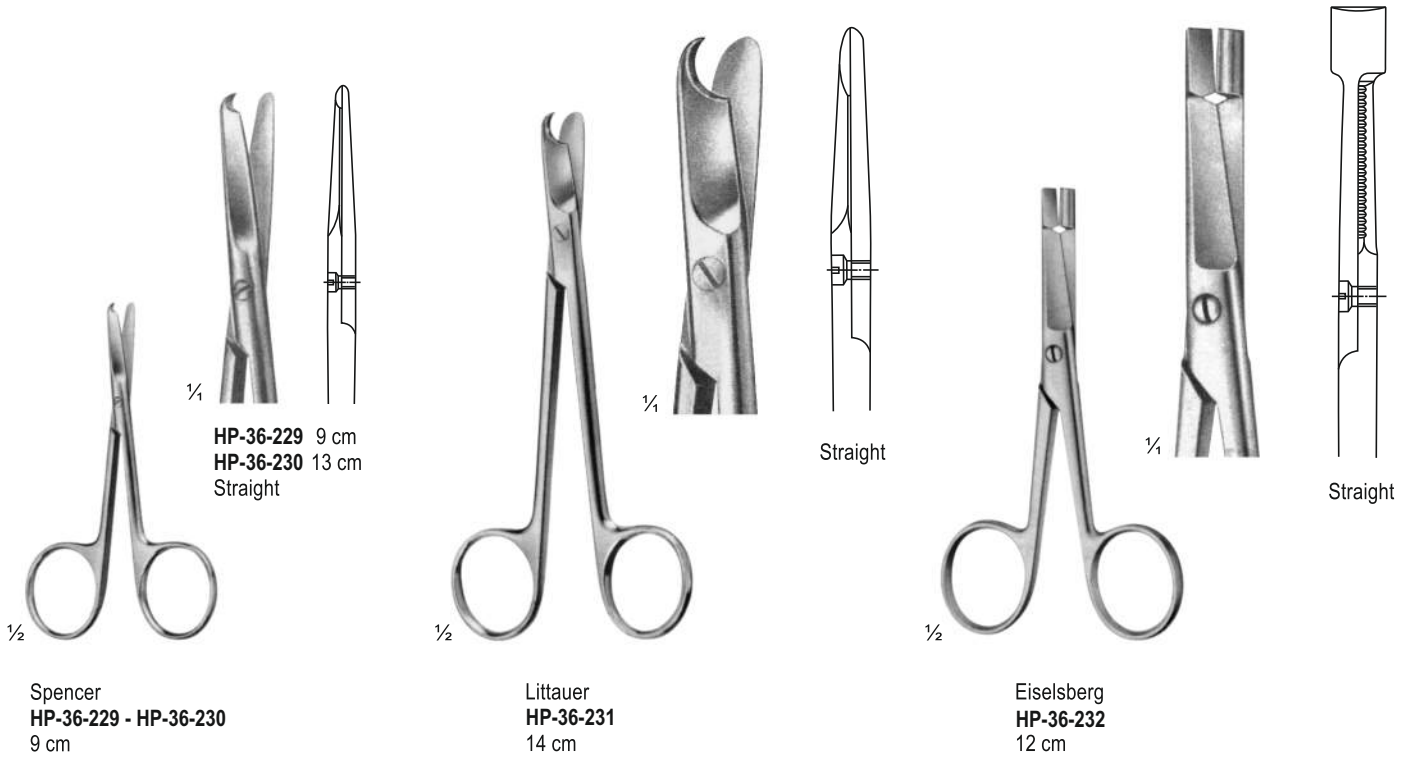



Beebee
HP-37-237 - HP-37-240
 10 cm

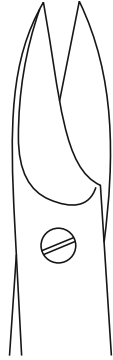

HP-37-237
 10 cm



Straight

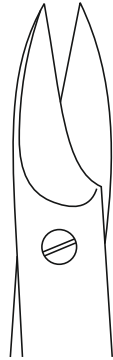

HP-37-238
 10 cm



Curved

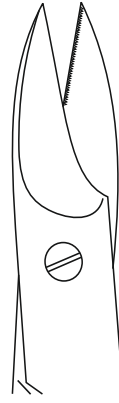

HP-37-239
 12 cm
 One toothed cutting edge



Straight

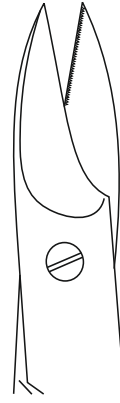

HP-37-240
 12 cm
 One toothed cutting edge



Curved



Universal Wire Cutting Scissors
HP-37-241
 12 cm
 One tooth cutting edge

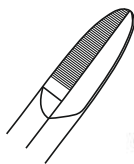

1/4



Harvey
HP-37-242
 12.5 cm
 Blades serrated



1/4

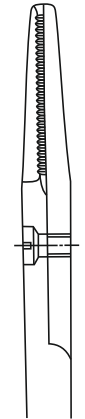

Straight

Enterotomy Scissors, Rectal Scissors

Enterotomieschere, Rektalschere
Tesoura Enterotomia, tesoura retal
Enterotomy Scissors, Rectal Scissors

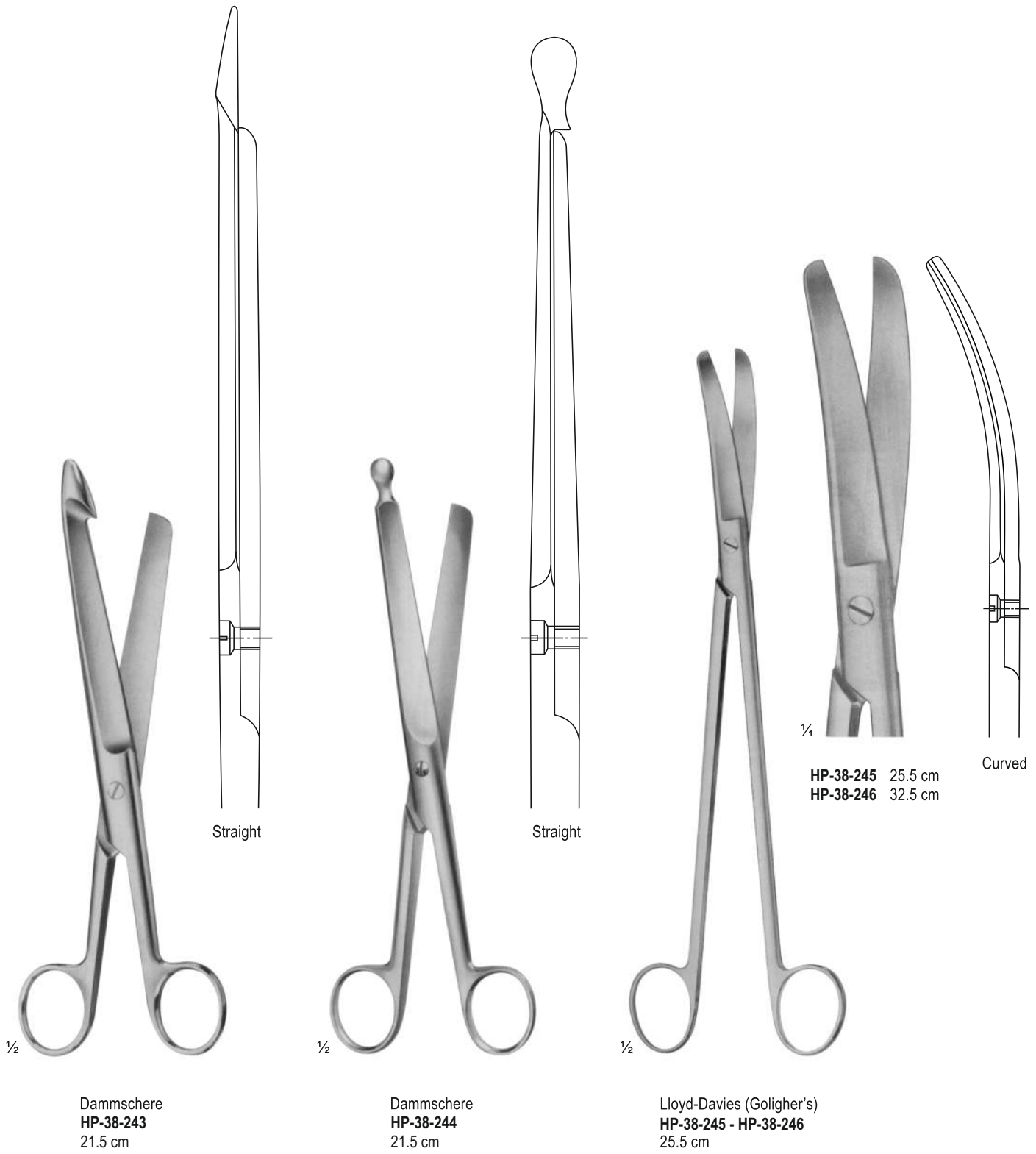



HP-39-247 - HP-39-254



A



D



A-SB

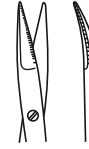

D-SB

		9 mm	9 mm	9 mm	9 mm
15 cm		HP-39-247	HP-39-248	HP-39-249	HP-39-250

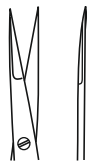

A



D



A-SB



D-SB

		14 mm	14 mm	14 mm	14 mm
15 cm		HP-39-251	HP-39-252	HP-39-253	HP-39-254



HP-39-255 - HP-39-262



A



D



A-SB



D-SB

		9 mm	9 mm	9 mm	9 mm
15 cm		HP-39-255	HP-39-256	HP-39-257	HP-39-258



A



D

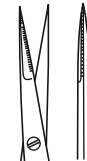

A-SB



D-SB

		14 mm	14 mm	14 mm	14 mm
15 cm		HP-39-259	HP-39-260	HP-39-261	HP-39-262

Micro Scissors
Mikroschere
Tesoura Micro
Micro tijeras



HP-40-263 - HP-40-279
15 cm



A



A



D



A-SB

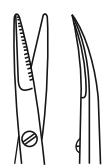

D-SB

		10 mm	10 mm	10 mm	10 mm	10 mm
15 cm	St	HP-40-263	HP-40-264			
15 cm	Ti	HP-40-265	HP-40-266			
18 cm	St	HP-40-267	HP-40-268	HP-40-269	HP-40-270	HP-40-271
18 cm	Ti	HP-40-272	HP-40-273			
21 cm	St	HP-40-274	HP-40-275			
21 cm	Ti	HP-40-276	HP-40-277			
23 cm	St	HP-40-278	HP-40-279			



HP-40-280 - HP-40-296
15 cm

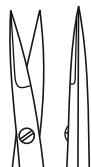

A



A



D



A-SB

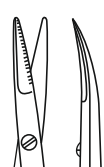

D-SB

		10 mm	10 mm	10 mm	10 mm	10 mm
15 cm	St	HP-40-280	HP-40-281			
15 cm	Ti	HP-40-282	HP-40-283			
18 cm	St	HP-40-284	HP-40-285	HP-40-286	HP-40-287	HP-40-288
18 cm	Ti	HP-40-289	HP-40-290			
21 cm	St	HP-40-291	HP-40-292			
21 cm	Ti	HP-40-293	HP-40-294			
23 cm	St	HP-40-295	HP-40-296			

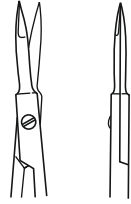
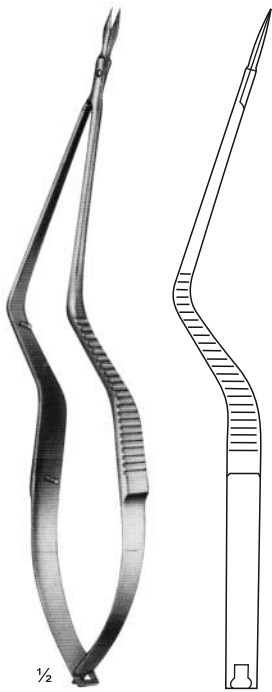

HP-41-297
20 cm
Straight

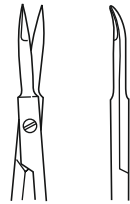

HP-41-298
20 cm
Curved

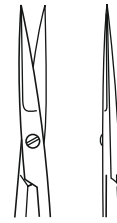
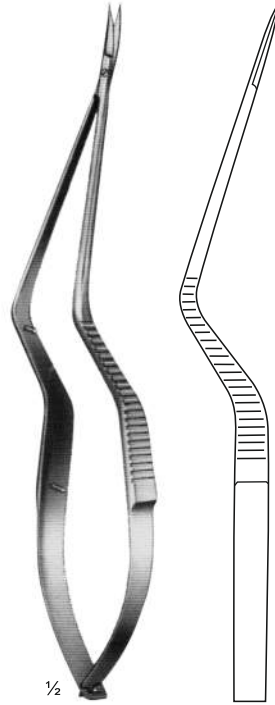

HP-41-299
19 cm
Straight

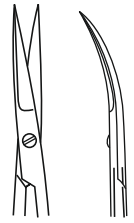

HP-41-300
18.5 cm
Bent Upwards

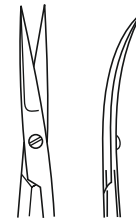

HP-41-301
18.5 cm
Bent Downwards

HP-41-297 - HP-41-298
18 cm

HP-41-299 - HP-41-301
19 cm

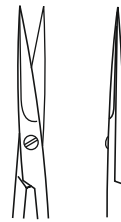
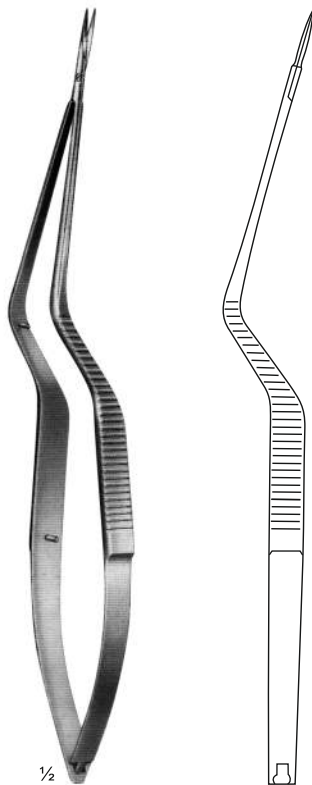

HP-41-302
Straight

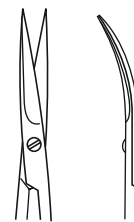

HP-41-303
Curved

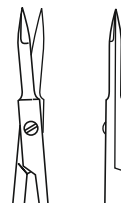

HP-41-304
Straight

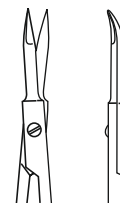

HP-41-305
Curved

Jacobson
HP-41-302 - HP-41-305
20.5 cm

Micro Scissors, Micro Dissecting Scissors

Mikroschere, Mikrodissektionsschere
Tesoura Micro, Tesoura Micro Dissecante
Micro Scissors, Micro Dissecting Scissors

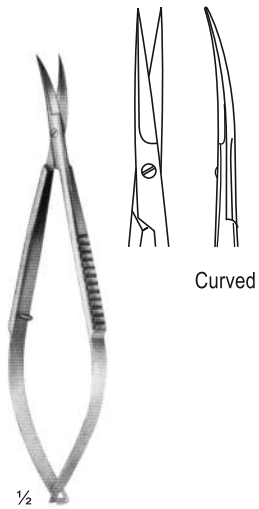

Curved

HP-42-306
12 cm

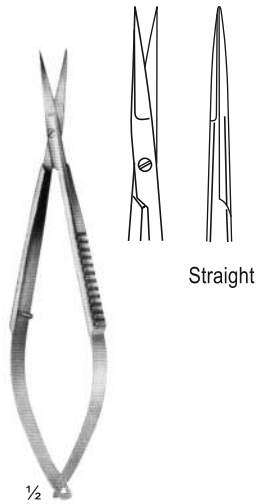

Straight

HP-42-307
12 cm

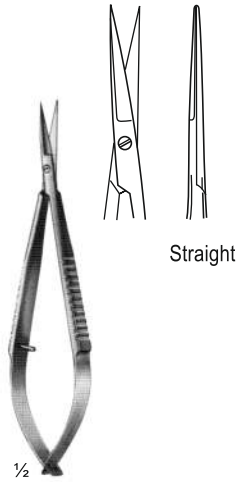

Straight

HP-42-308
10 cm

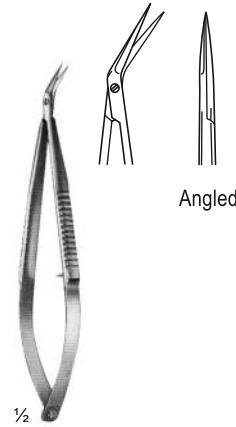

Angled

HP-42-309
9.5 cm



Biemer
HP-42-310
12 cm
Micro scissore for veins
For roughening vessel ends,
vessel cannot slip off, clean,
smooth cut



Yasargil-Type-Vannas, Bayonet Scissors

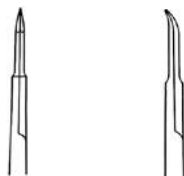

HP-42-311
22.5 cm
Straight



HP-42-312
22.5 cm
Curved

Yasargil-Type, Bayonet Scissors



HP-42-313
16.5 cm

HP-42-316
16.5 cm

HP-42-320
20 cm
Curved

HP-42-314
20 cm

HP-42-317
20 cm

HP-42-315
22.5 cm
Straight

HP-42-318
22.5 cm

HP-42-319
24.5 cm
Curved

Yasargil-Type, Bayonet Dissection Scissors



HP-42-321
20 cm

HP-42-323
20 cm

HP-42-322
22.5 cm
Straight

HP-42-324
22.5 cm
Curved

Yasargil-Type
HP-42-311 - HP-42-324
Scissors

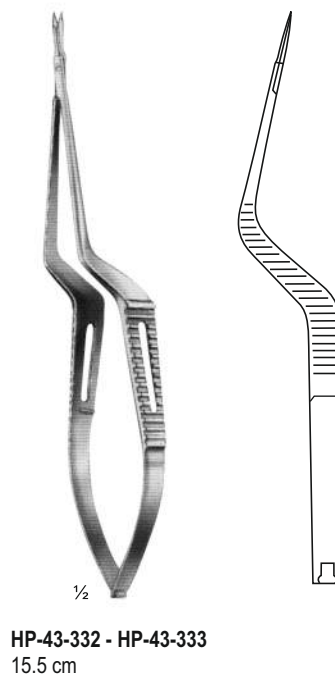
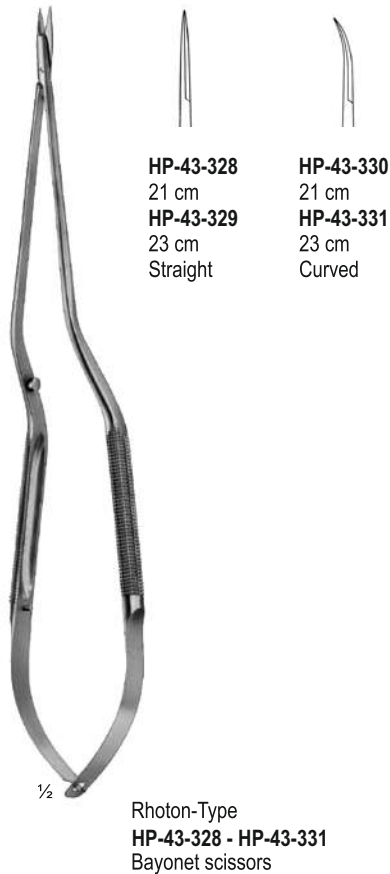
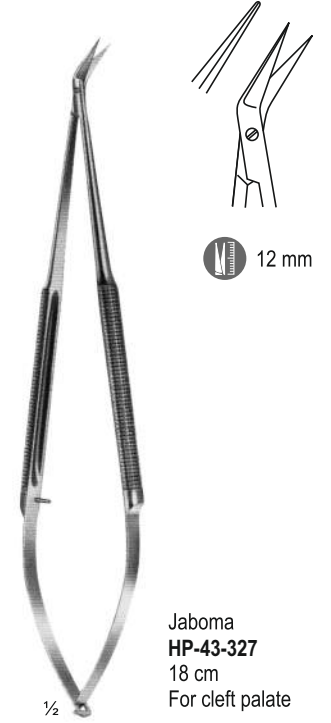

Ceramic Coated Scissors

Keramik beschichtete Schere
Tesoura Revestida Cerâmica
Tijeras revestidas de cerámica



18 cm

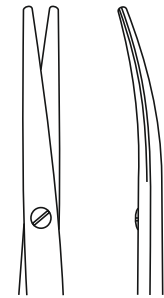

Curved

- HP-44-334 12 cm
- HP-44-335 18 cm
- HP-44-336 20.5 cm
- HP-44-337 23 cm
- HP-44-338 25 cm
- HP-44-339 30 cm

Metzenbaum

HP-44-334 - HP-44-339
Coated with ceramics,
one toothed cutting edge



14 cm

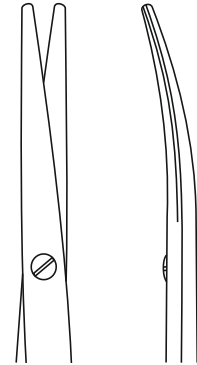

Curved

- HP-44-340 14 cm
- HP-44-341 18 cm

Tönnis-Adson

HP-44-340 - HP-44-341
Coated with ceramics,
one toothed cutting edge



1/2

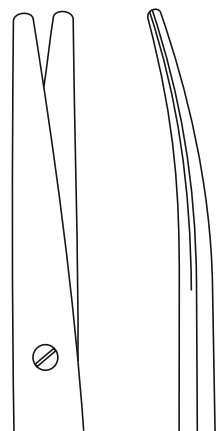

Curved

Mayo-Lexer

HP-44-342
16 cm
Coated with ceramics,
one toothed cutting edge

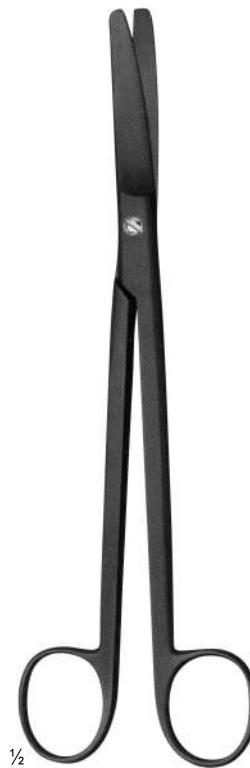

1/2

20 cm

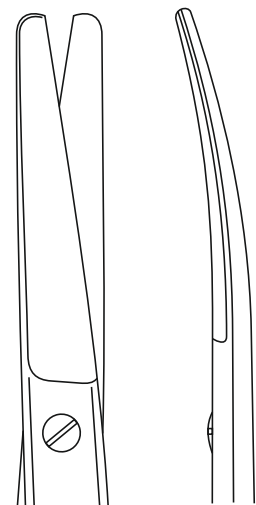

Curved

- HP-44-343 20 cm
- HP-44-344 23 cm

Uterine Scissors

Sims

HP-44-343 - HP-44-344
Coated with ceramics,
one toothed cutting edge



1/2

Metzenbaum
HP-45-345 - HP-45-350
 18 cm

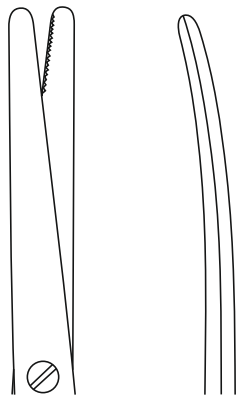

Curved
HP-45-345 18 cm
HP-45-346 20 cm
HP-45-347 23 cm
HP-45-348 26 cm
HP-45-349 28.5 cm
HP-45-350 31 cm



1/2

Ligature Scissors
HP-45-351 - HP-45-353
 For synthetic suture material,
 one toothed cutting edge
 14.5 cm

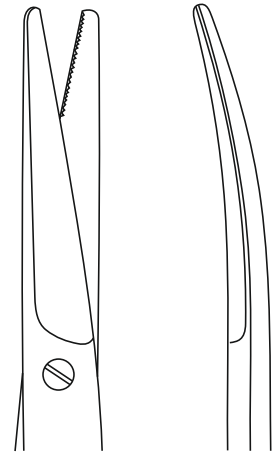

Curved
HP-45-351 14.5 cm
HP-45-352 17 cm
HP-45-353 23 cm



1/2

Iris
HP-45-354
 11.5 cm

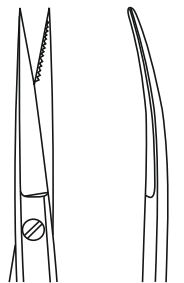

Curved



1/2

Ligature Scissors
HP-45-355 - HP-45-358
 For synthetic suture material,
 one toothed cutting edge
 14.5 cm

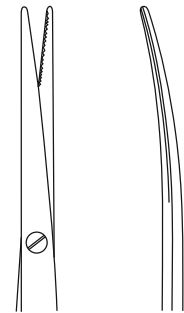

Curved
HP-45-355 14.5 cm
HP-45-356 23 cm
HP-45-357 25 cm
HP-45-358 30 cm

Aquila Scissors T.C.

Aquila Schere T.C.
Aquila Scissors T.C.
Aquila Scissors T.C.



1/2

Metzenbaum-Aquila
HP-46-359 - HP-46-364
One toothed cutting edge / one cutting edge with knife cut
18 cm

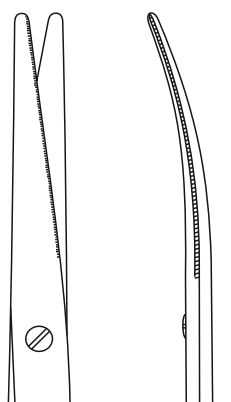

Curved

- HP-46-359** 12 cm
- HP-46-360** 18 cm
- HP-46-361** 20 cm
- HP-46-362** 23 cm
- HP-46-363** 25 cm
- HP-46-364** 30 cm



1/2

Metzenbaum-Aquila-Fine
HP-46-365 - HP-46-366
One toothed cutting edge/
one cutting edge with knife cut
14 cm

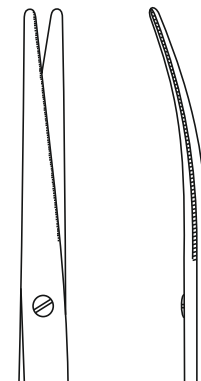

Curved

- HP-46-365** 14 cm
- HP-46-366** 18 cm



1/2

Tönnis-Adson-Aquila
HP-46-367
17.5 cm
One toothed cutting edge/
one cutting edge with knife cut

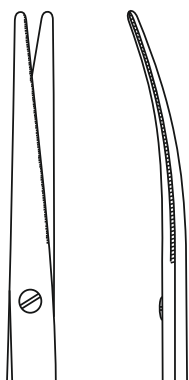

Curved

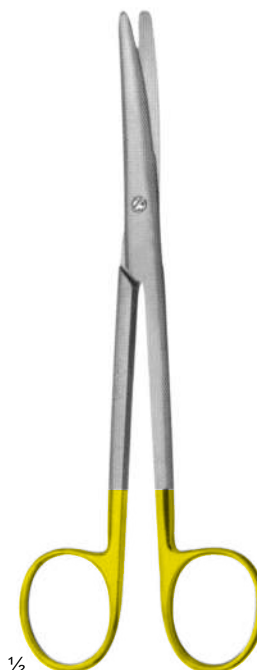

1/2

Mayo-Lexer-Aquila
HP-46-368
17.5 cm
One toothed cutting edge/
one cutting edge with knife cut

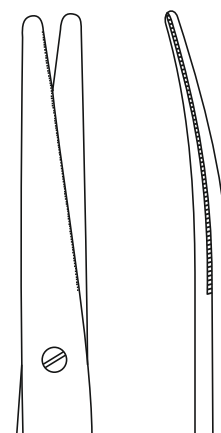

Curved



Operating Scissors
HP-47-369 - HP-47-374
 14.5 cm

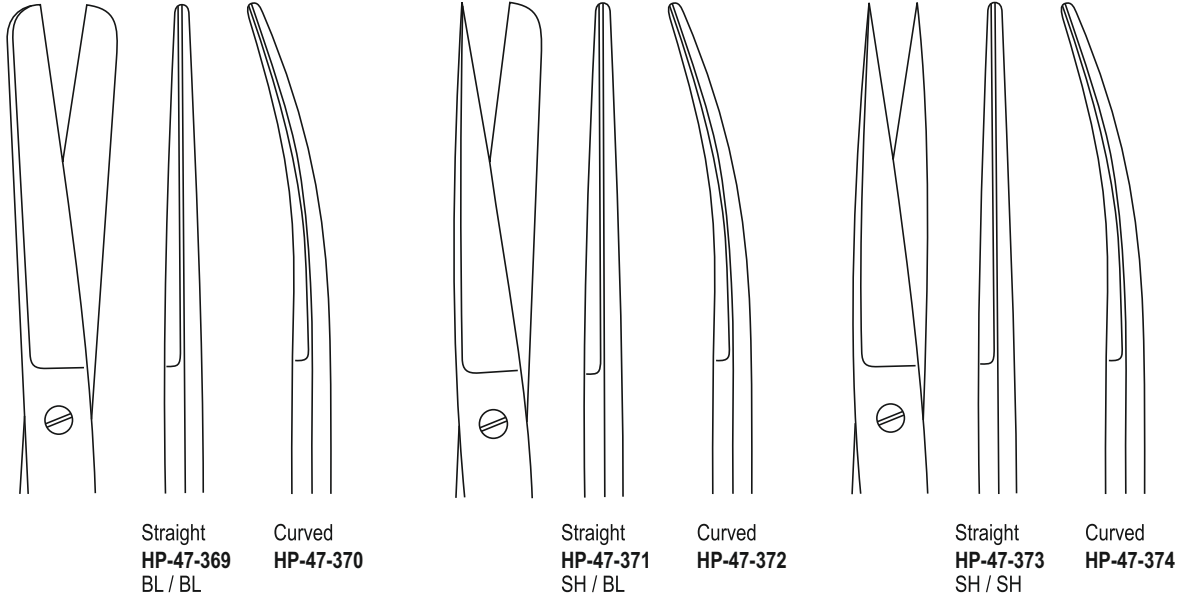

Mayo
HP-47-375 - HP-47-380
 14.5 cm

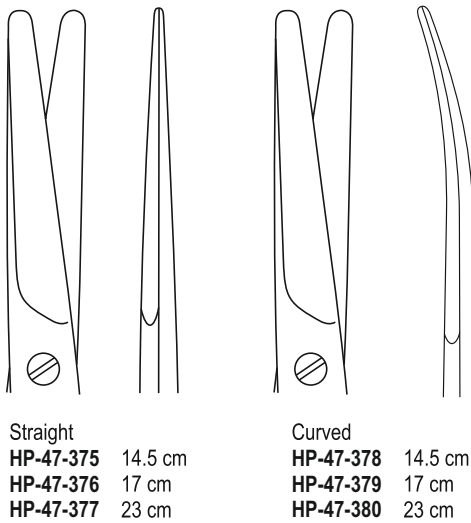

Joseph
HP-47-381 - HP-47-382

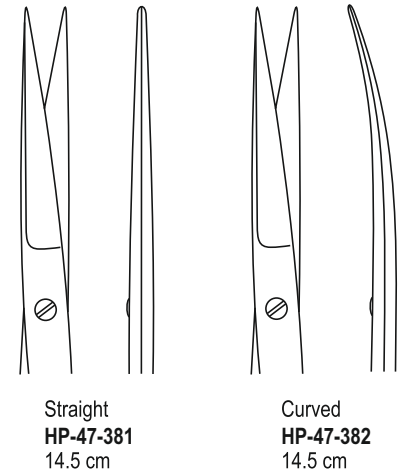

Dissecting Scissors, Hysterectomy Scissors T.C.
Präparierschere, Hysterektomieschere T.C.
Tesoura de dissecação, Tesoura de histerectomia T.C.
Tijeras de disección, tijeras de histerectomía T.C.

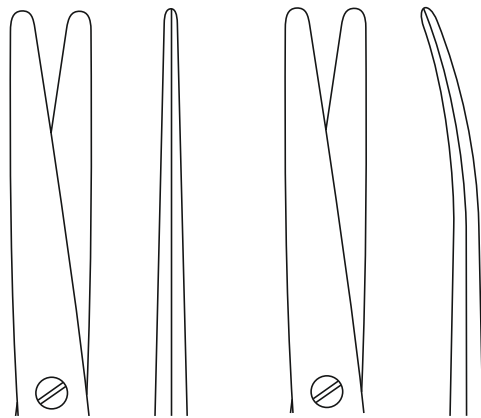

Straight
HP-48-383 16 cm
HP-48-384 21 cm

Curved
HP-48-385 16 cm
HP-48-386 21 cm

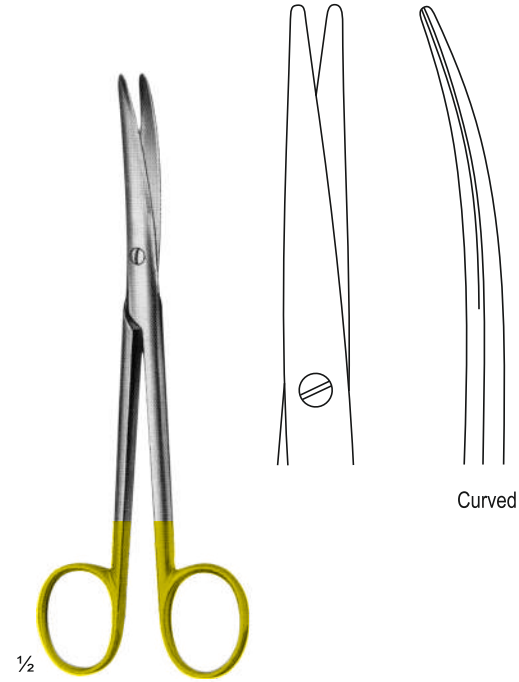

Mayo-Lexer
HP-48-387
16 cm
Dissecting scissors

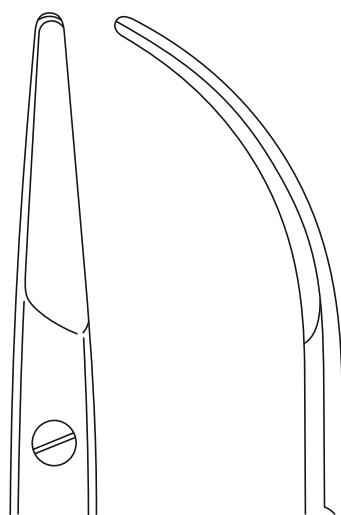

Curved
HP-48-388
22 cm



Curved
HP-48-389
23 cm

Parametrium
HP-48-388 - HP-48-389
22 cm
Hysterectomy scissors
heavy pattern

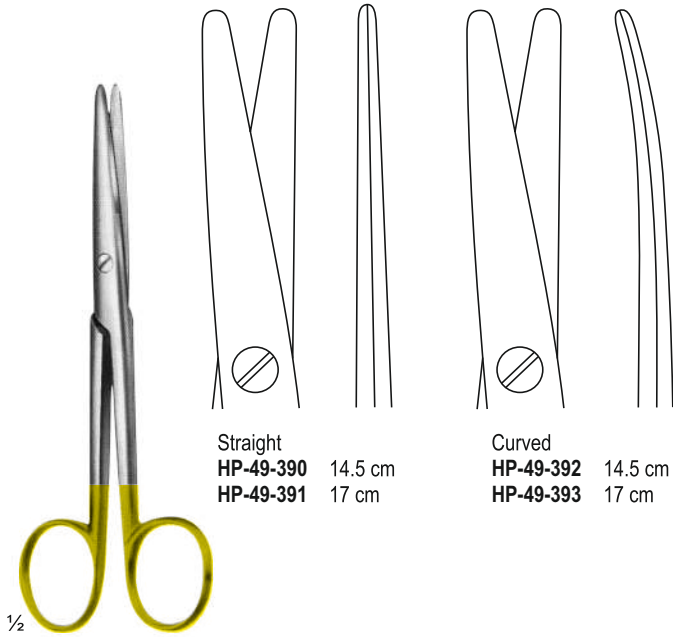

Straight
HP-49-390 14.5 cm
HP-49-391 17 cm

Curved
HP-49-392 14.5 cm
HP-49-393 17 cm

Mayo-Stiller
HP-49-390 - HP-49-393
 14.5 cm

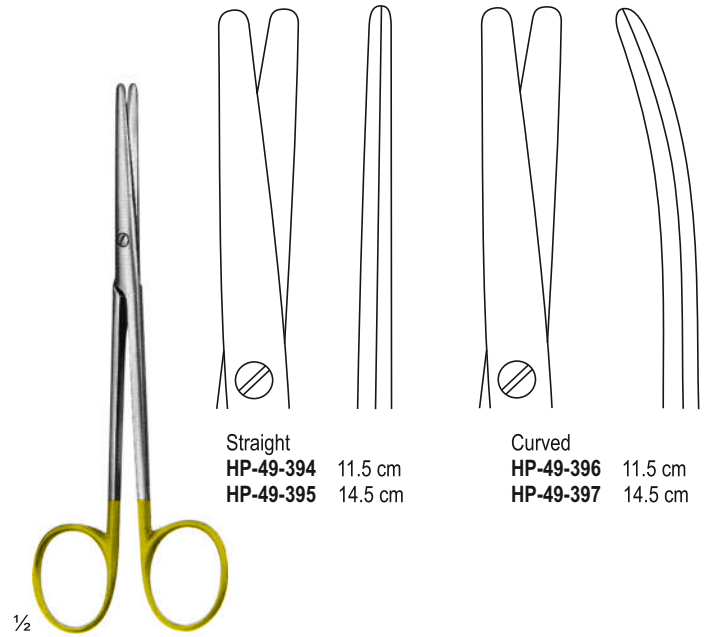

Straight
HP-49-394 11.5 cm
HP-49-395 14.5 cm

Curved
HP-49-396 11.5 cm
HP-49-397 14.5 cm

Metzenbaum
HP-49-394 - HP-49-397
 14.5 cm

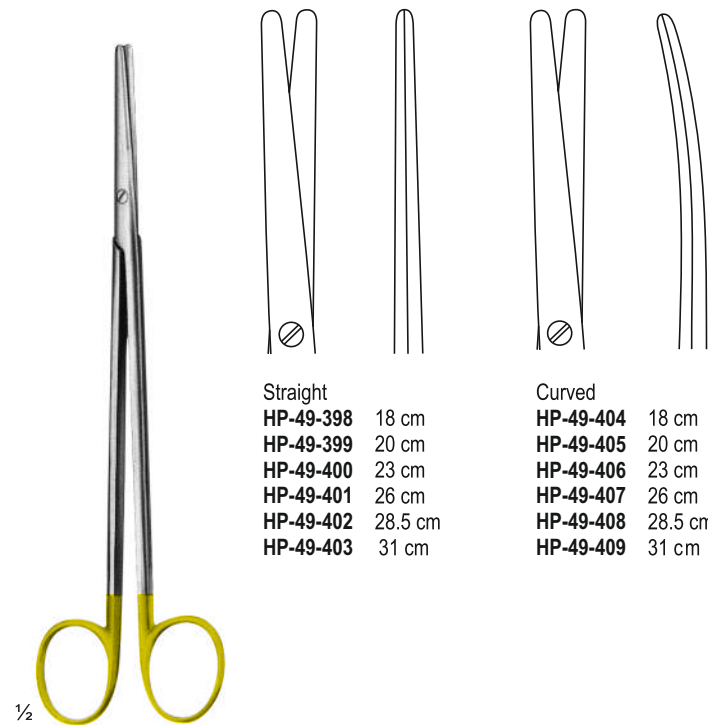

Straight
HP-49-398 18 cm
HP-49-399 20 cm
HP-49-400 23 cm
HP-49-401 26 cm
HP-49-402 28.5 cm
HP-49-403 31 cm

Curved
HP-49-404 18 cm
HP-49-405 20 cm
HP-49-406 23 cm
HP-49-407 26 cm
HP-49-408 28.5 cm
HP-49-409 31 cm

Metzenbaum
HP-49-398 - HP-49-409
 18 cm

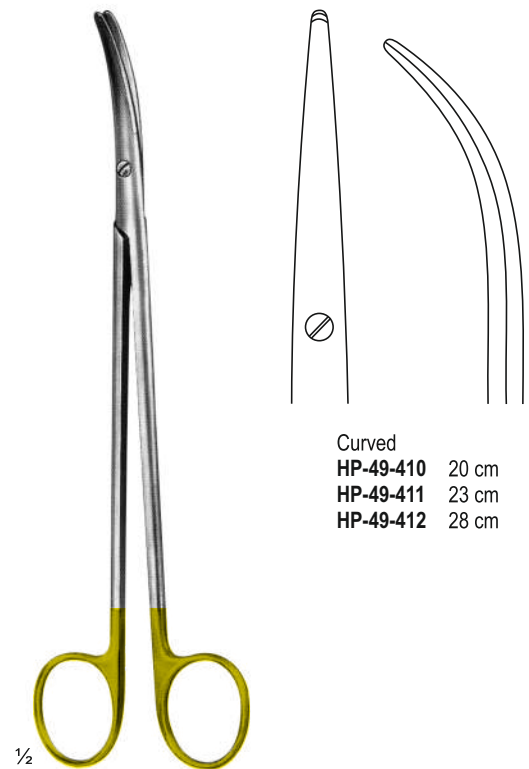

Curved
HP-49-410 20 cm
HP-49-411 23 cm
HP-49-412 28 cm

Metzenbaum-Thorek
HP-49-410 - HP-49-412
 20 cm

Delicate Dissecting Scissors T.C., Face-Lift Scissors T.C.

Delicate Dissecting Scissors T. C., Face-Lift-Schere T.C.

Tesoura Dissecante Delicada T.C., Tesoura Face-Lift T.C.

Tijera de disección delicada T.C., tijera de estiramiento facial T.C.



1/2

Straight
HP-50-413 14.5 cm
HP-50-414 18 cm
HP-50-415 20.5 cm
HP-50-416 23 cm

Metzenbaum-Fine
HP-50-413 - HP-50-420
 18 cm

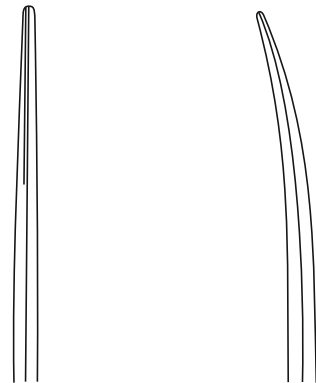

Curved
HP-50-417 14.5 cm
HP-50-418 18 cm
HP-50-419 20.5 cm
HP-50-420 23 cm

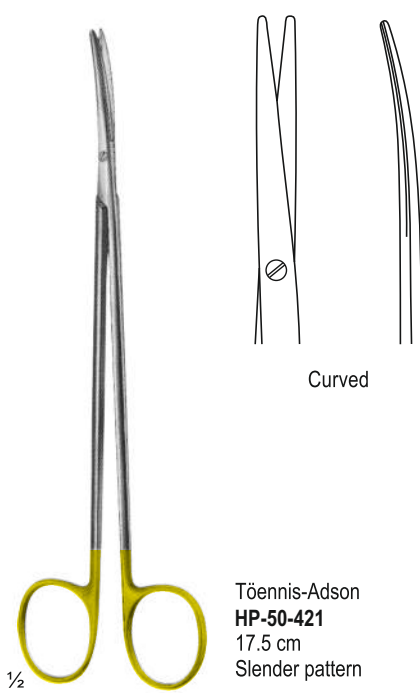

1/2

Töennis-Adson
HP-50-421
 17.5 cm
 Slender pattern



Curved

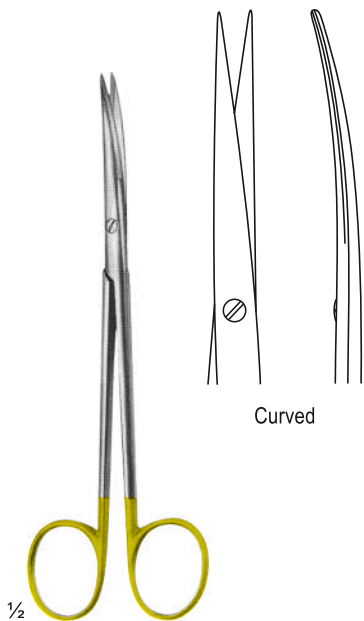

1/2

Metzenbaum-Lahey
HP-50-422
 14.5 cm
 Slender pattern

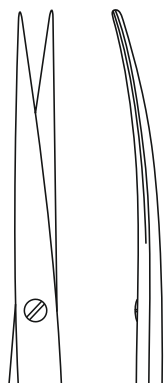

Curved



1/2

Rees
HP-50-423
 17 cm
 Face-lift scissors
 one toothed cutting edge



Curved



1/2

Gorney
HP-50-424 - HP-50-425
 20.5 cm
 Face-lift scissors
 one toothed cutting edge

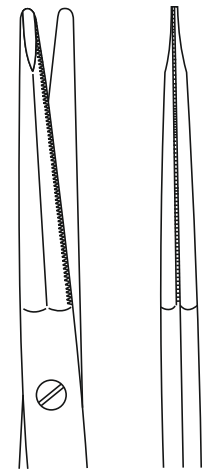

Straight
HP-50-424 20.5 cm
HP-50-425 23 cm

Uterine, Ligature, Iris Scissors T.C.
 Gebärmutter, Ligatur, Irisschere T.C.
 Uterina, Ligadura, Iris Scissors T.C.
 Uterino, Ligadura, Iris Tijera T.C.

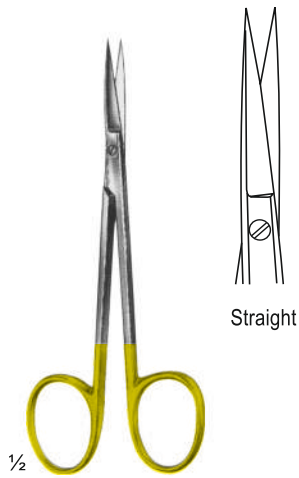

Iris
HP-51-426
 11.5 cm

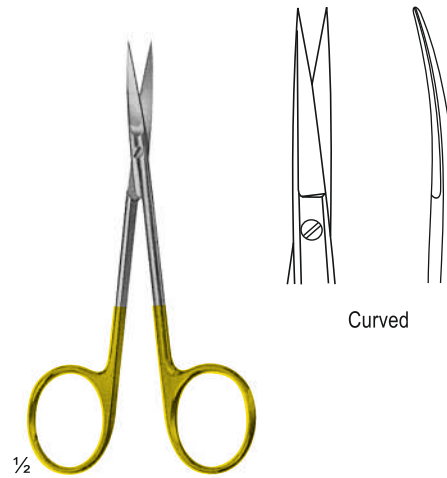

Iris
HP-51-427
 11.5 cm

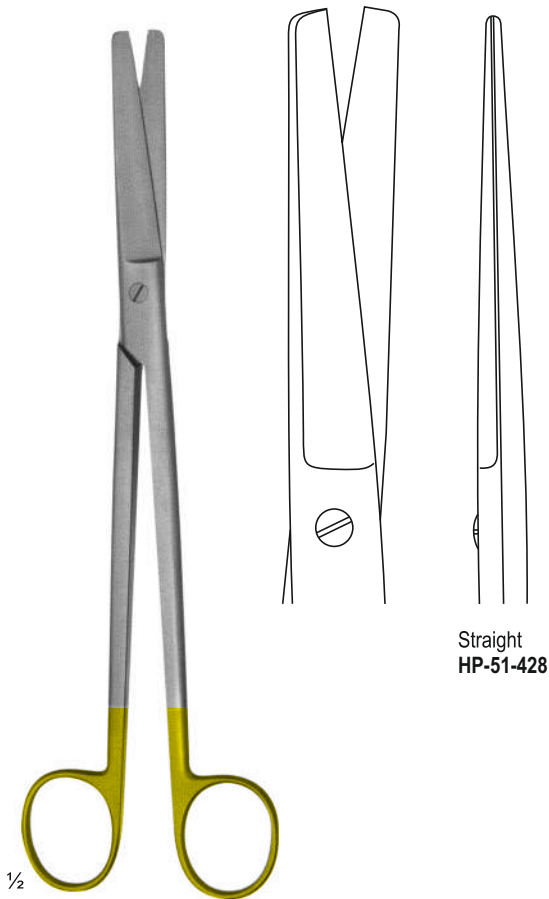

Sims
HP-51-428 - HP-51-429
 23 cm

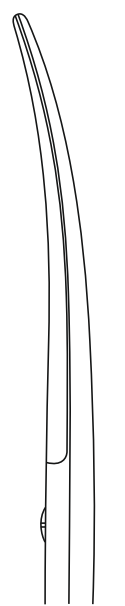

Straight
HP-51-428
 Curved
HP-51-429

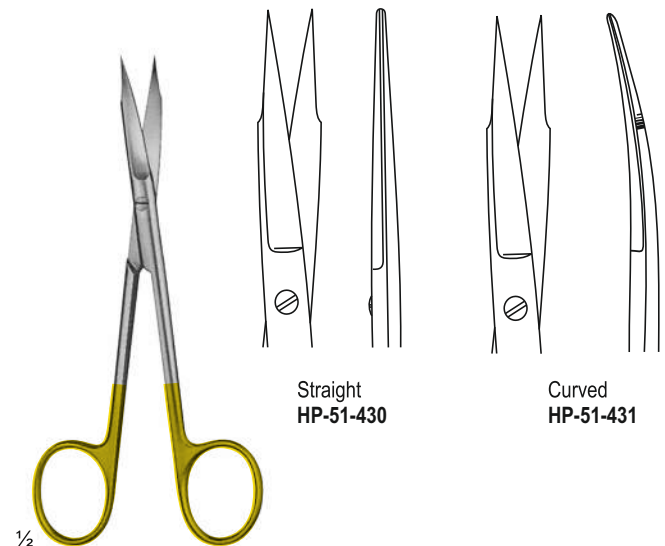

Goldmann-Fox
HP-51-430 - HP-51-431
 13 cm
 One toothed cutting edge

Straight
HP-51-430

Curved
HP-51-431

Angled Scissors T.C.
Winkelschere T.C.
Tesoura Angular T.C.
Tijera en ángulo T.C.



1/2

DeBakey
HP-52-432 - HP-52-437
23 cm

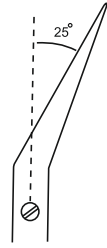

HP-52-432
19 cm

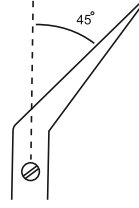

HP-52-433
18.5 cm

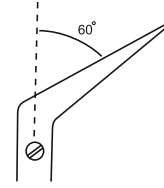

HP-52-434
18 cm

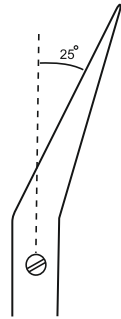

HP-52-435
23 cm

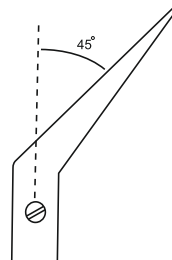

HP-52-436
23 cm

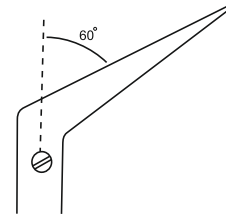

HP-52-437
22 cm



1/2

HP-52-438
11 cm



1/2

Locklin
HP-51-442
16 cm
Gum scissors
one toothed cutting edge

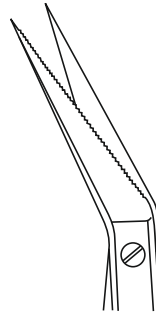

1/2

Locklin
HP-51-443
16 cm
Gum scissors
one toothed cutting edge

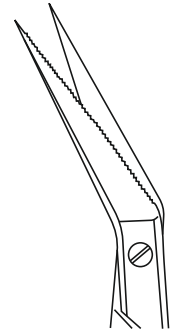



Dissecting & Tissue Forceps

Präparierende & Gewebszange

Pinça de disseção e tecido

Dissección y pinzas de tejido

Page 53-71

Dissecting Forceps

Präparierzange
Pinça de dissecação
Pinzas de disección

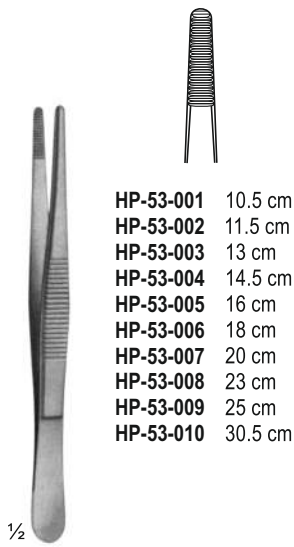

- HP-53-001 10.5 cm
- HP-53-002 11.5 cm
- HP-53-003 13 cm
- HP-53-004 14.5 cm
- HP-53-005 16 cm
- HP-53-006 18 cm
- HP-53-007 20 cm
- HP-53-008 23 cm
- HP-53-009 25 cm
- HP-53-010 30.5 cm

Standard (Thumb)
HP-53-001 - HP-53-010
11.5 cm

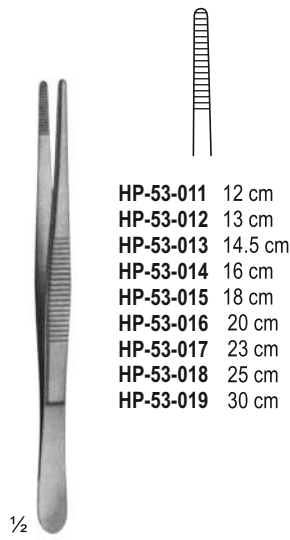

- HP-53-011 12 cm
- HP-53-012 13 cm
- HP-53-013 14.5 cm
- HP-53-014 16 cm
- HP-53-015 18 cm
- HP-53-016 20 cm
- HP-53-017 23 cm
- HP-53-018 25 cm
- HP-53-019 30 cm

Narrow (Thumb)
HP-53-011 - HP-53-019
12 cm

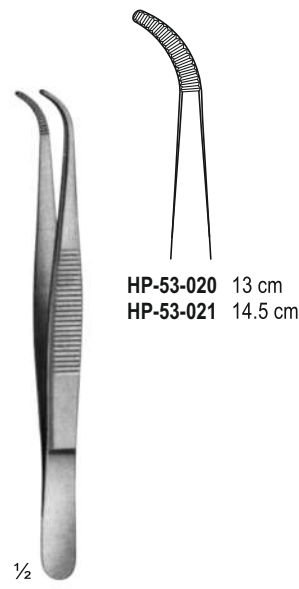

- HP-53-020 13 cm
- HP-53-021 14.5 cm

Narrow
HP-53-020 - HP-53-021
13 cm
Curved

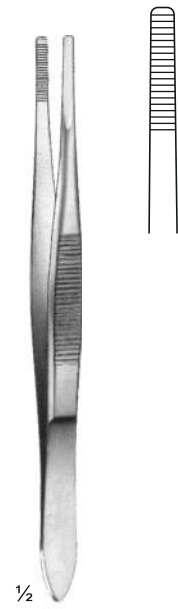

Stille
HP-53-022
15 cm

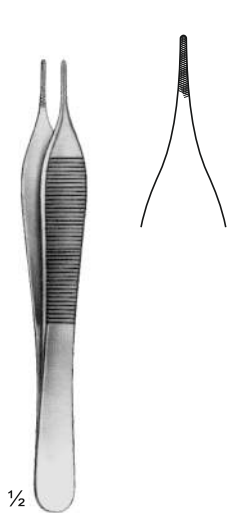

Adson
HP-53-023
12 cm

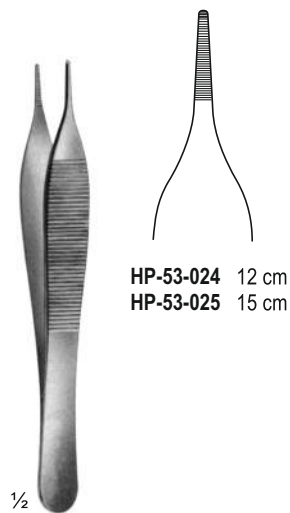

- HP-53-024 12 cm
- HP-53-025 15 cm

Adson
HP-53-024 - HP-53-025
12 cm

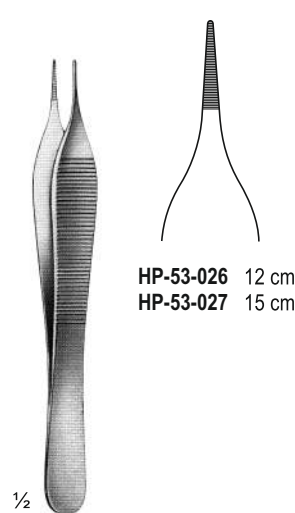

- HP-53-026 12 cm
- HP-53-027 15 cm

Micro-Adson
HP-53-026 - HP-53-027
12 cm

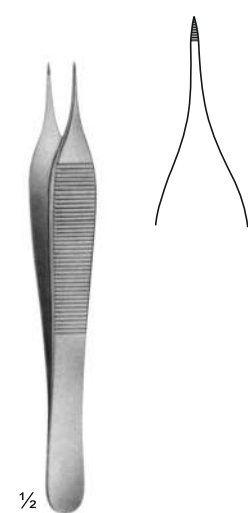

Thorek
HP-53-028
12 cm
Corneal forceps



HP-54-029 12.5 cm
 HP-54-030 15 cm

1/2
 Semken
 HP-54-029 - HP-54-030
 12.5 cm



HP-54-031 15 cm
 HP-54-032 17 cm
 HP-54-033 20 cm

1/2
 Schweden-Modell
 HP-54-031 - HP-54-033
 15 cm

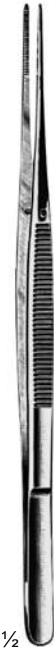

1/2
 Taylor
 HP-54-034
 17 cm



1/2
 Taylor
 HP-54-035
 18 cm
 With dissector end



HP-54-036 18 cm
 HP-54-037 21 cm
 HP-54-038 25 cm
 HP-54-039 30 cm

1/2
 Potts-smith
 HP-54-036 - HP-54-039
 18 cm



1/2
 Waugh
 HP-54-040
 20 cm



1/2
 Brophy
 HP-54-041 - HP-54-042



HP-54-041
 20 cm
 Straight

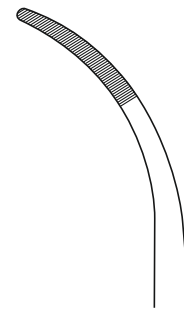

HP-54-042
 20 cm
 Curved



1/2
 Brophy
 HP-54-043
 20 cm



Angled

Dissecting Forceps

Präparierzange
Pinça de dissecação
Pinzas de disección

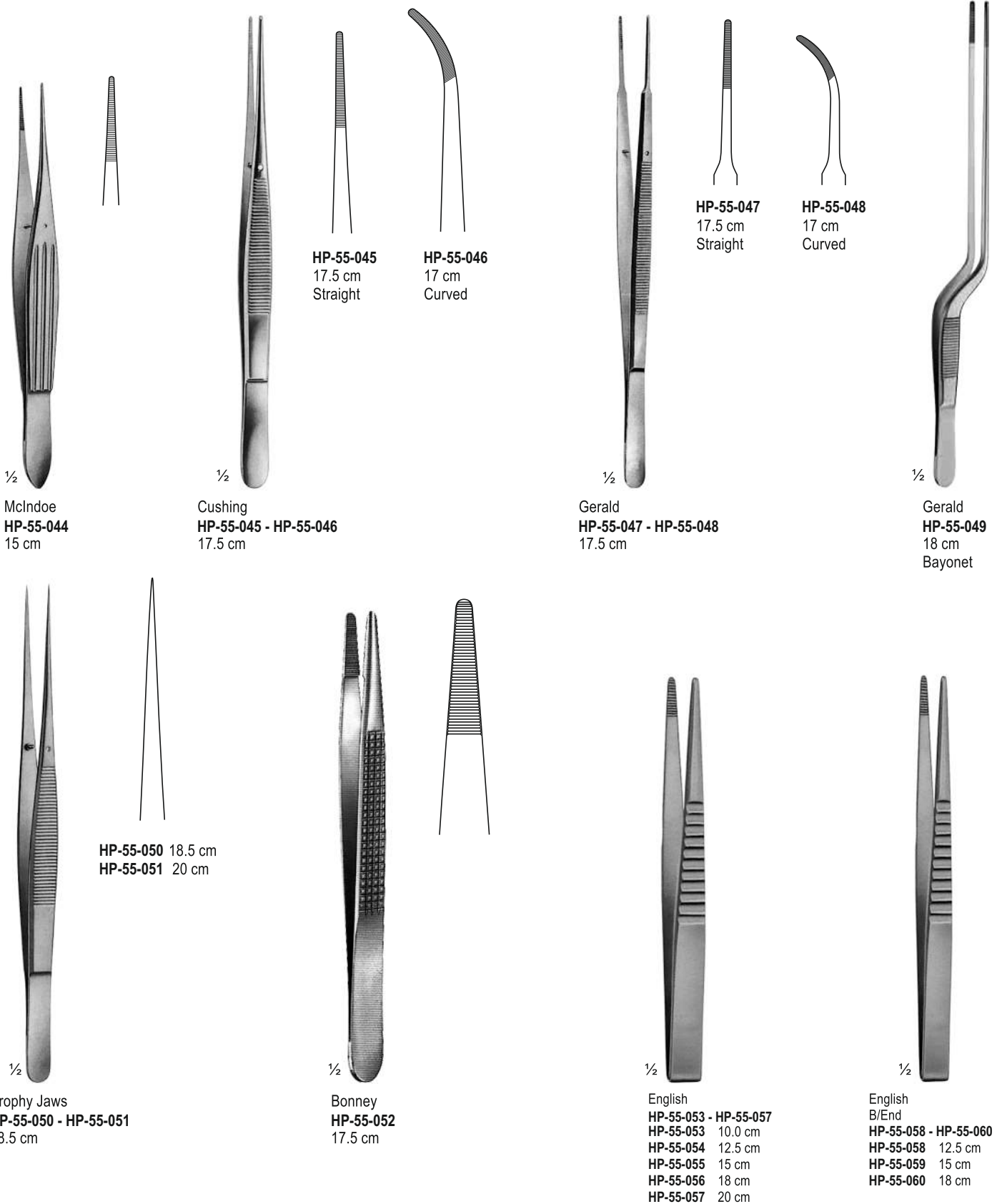

1/2
McIndoe
HP-55-044
15 cm

1/2
Cushing
HP-55-045 - HP-55-046
17.5 cm

HP-55-045
17.5 cm
Straight

HP-55-046
17 cm
Curved

1/2
Gerald
HP-55-047 - HP-55-048
17.5 cm

HP-55-047
17.5 cm
Straight

HP-55-048
17 cm
Curved

1/2
Gerald
HP-55-049
18 cm
Bayonet

HP-55-050 18.5 cm
HP-55-051 20 cm

1/2
Brophy Jaws
HP-55-050 - HP-55-051
18.5 cm

1/2
Bonney
HP-55-052
17.5 cm

1/2
English
HP-55-053 - HP-55-057
HP-55-053 10.0 cm
HP-55-054 12.5 cm
HP-55-055 15 cm
HP-55-056 18 cm
HP-55-057 20 cm

1/2
English
B/End
HP-55-058 - HP-55-060
HP-55-058 12.5 cm
HP-55-059 15 cm
HP-55-060 18 cm

1.5 mm	2 mm	2.8 mm	3.3 mm	2 mm
HP-56-061 15 cm HP-56-062 20 cm	HP-56-063 15 cm HP-56-064 20 cm HP-56-065 24 cm HP-56-066 30 cm	HP-56-067 15 cm HP-56-068 20 cm HP-56-069 24 cm HP-56-070 30 cm	HP-56-071 20 cm HP-56-072 24 cm HP-56-073 30 cm	
1/2	1/2	1/2	1/2	1/2
DeBakey HP-56-061 - HP-56-062 15 cm	DeBakey HP-56-063 - HP-56-066 15 cm	DeBakey HP-56-067 - HP-56-070 15 cm	DeBakey HP-56-071 - HP-56-073 15 cm	DeBakey HP-56-074 20 cm

1.8 mm	1.5 mm			
HP-56-075 16 cm HP-56-076 20.5 cm HP-56-077 24.5 cm	HP-56-078 16 cm HP-56-079 20.5 cm HP-56-080 24.5 cm			HP-56-083 17.5 cm HP-56-084 23 cm
1/2	1/2	1/2	1/2	1/2
DeBakey HP-56-075 - HP-56-077 16 cm	DeBakey HP-56-078 - HP-56-080 16 cm	HP-56-081 17.5 cm	DeBakey HP-56-082 15 cm	Gerald HP-56-083 - HP-56-084 17.5 cm

Bayonet - Shaped Forceps, Ear Forceps, Nasal Forceps

Bajonett - förmige Pinzette, Ohrzange, Nasenklemme
Pinça em Forma de Baioneta, Pinça de Orelha, Fórceps Nasal
Bayoneta - Pinza con forma, Pinza para el oído, Pinza nasal



1/2

Grüenwald
HP-57-085
20 cm
Ear forceps



1/2

Taylor
HP-57-086
18.5 cm
Dressing forceps with
dissector end



1/2

Jansen
HP-57-087
16 cm
Nasal tampon
forceps



1/2

Lucae
HP-57-088
14 cm
Ear forceps



1/2

Cottle
HP-57-089
14 cm
Skin Grasping forceps with
jaws toothed and serrated



1/2

Tröeltsch
HP-57-090 - HP-57-091
HP-57-090 10 cm
HP-57-091 11.5 cm
Nasal tampon
forceps

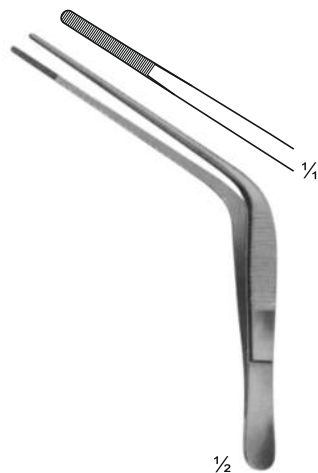

1/2

Wilde
HP-57-092
11.5 cm
Ear forceps

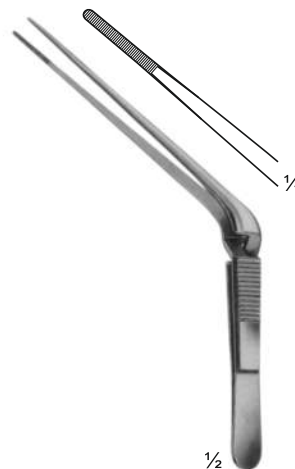

1/2

Tröeltsch (Wilde)
HP-57-093
12 cm
Nasal tampon forceps
cross action

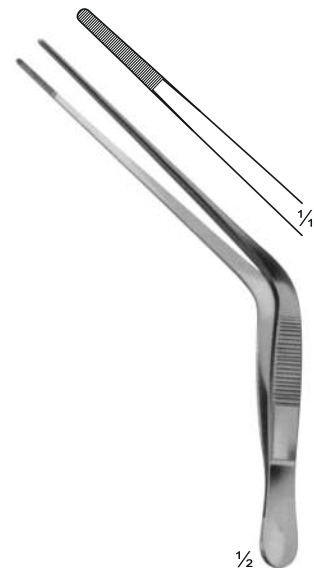

1/2

Tröeltsch
HP-57-094
14 cm
Nasal tampon
forceps

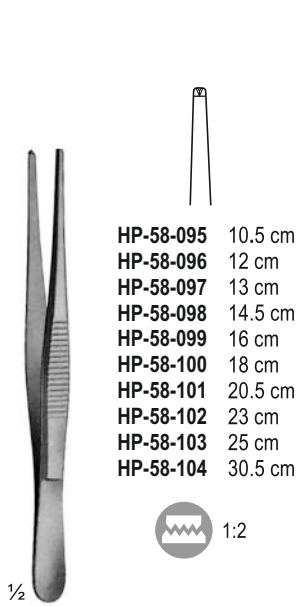

Standard (Tissue)
HP-58-095 - HP-58-104
12 cm

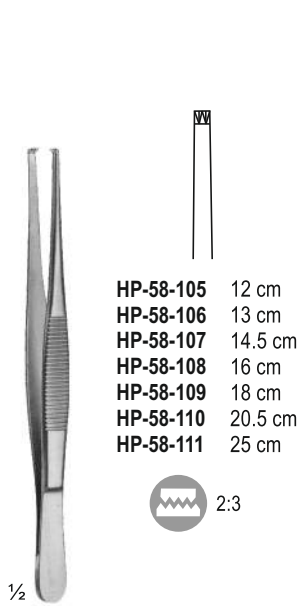

HP-58-105 - HP-58-111
12 cm

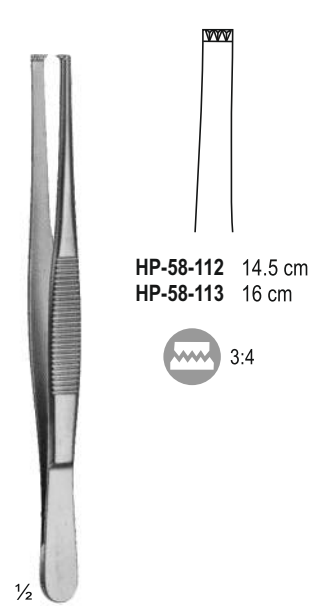

HP-58-112 - HP-58-113
14.5 cm

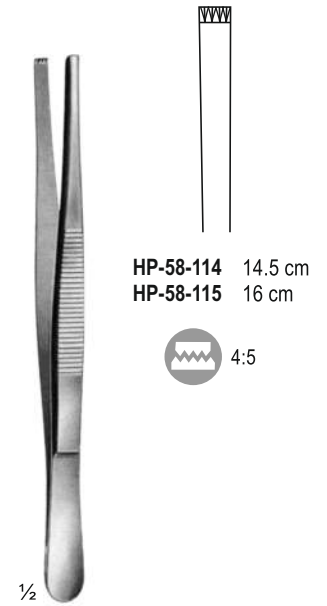

HP-58-114 - HP-58-115
14.5 cm

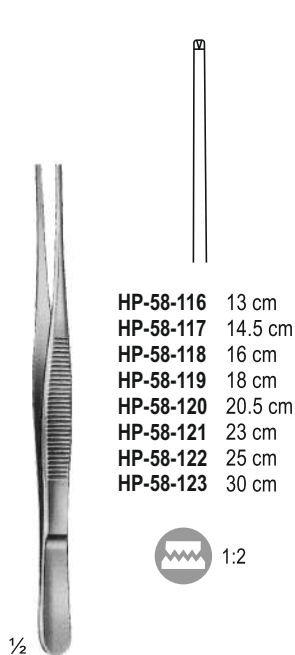

HP-58-116 - HP-58-123
Medium
13 cm

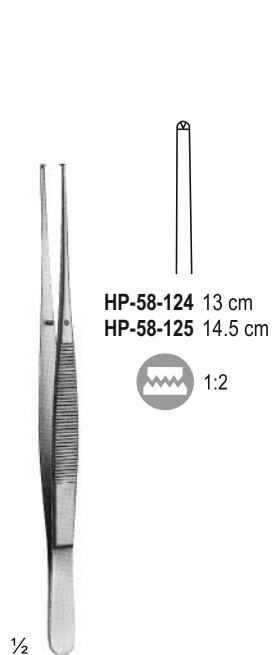

HP-58-124 - HP-58-125
13 cm

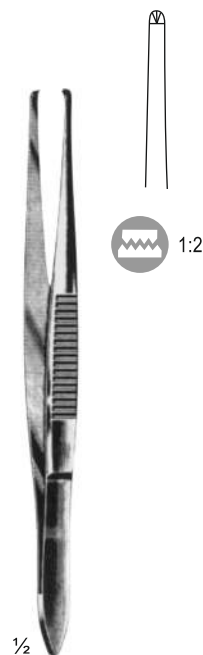

Stille
HP-58-126
15 cm

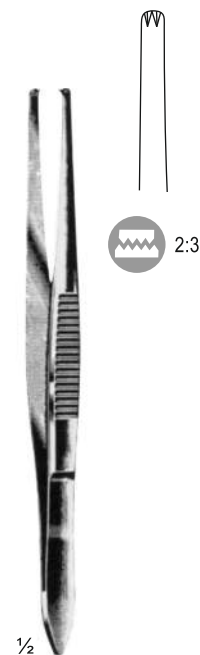

Stille
HP-58-127
15 cm

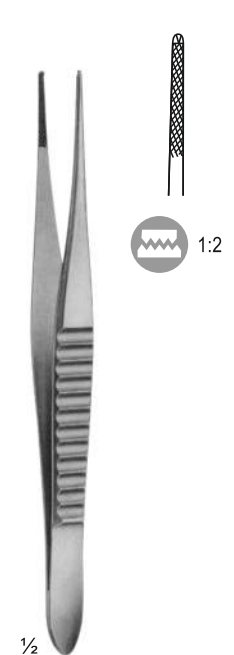

Gillies
HP-58-128
15.5 cm

Tissue Forceps
Gewebefingerzange
Pinça de tecido
Pinzas de tejido



Graefe
HP-59-129
10 cm

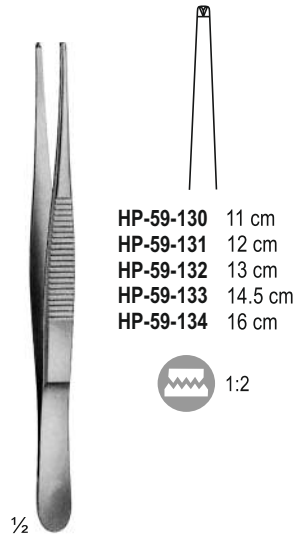

Graefe
HP-59-130 - HP-59-134
13 cm

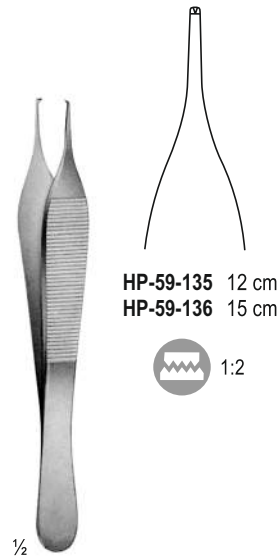

Adson
HP-59-135 - HP-59-136
12 cm

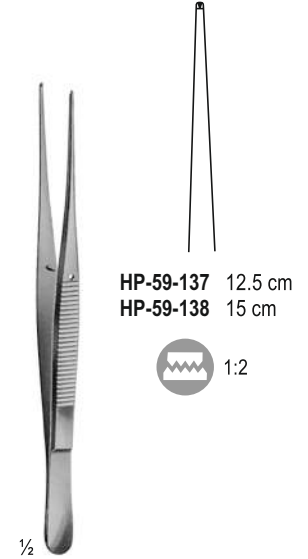

Semken
HP-59-137 - HP-59-138
12.5 cm

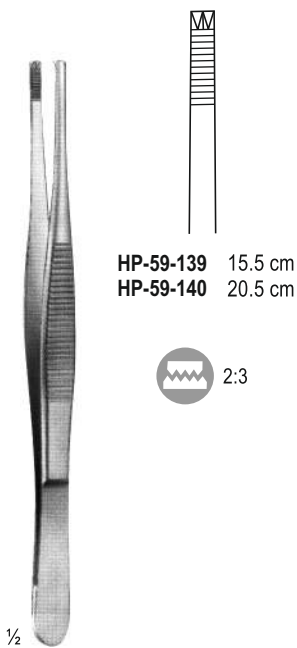

Adlerkreuz
HP-59-139 - HP-59-143
15.5 cm

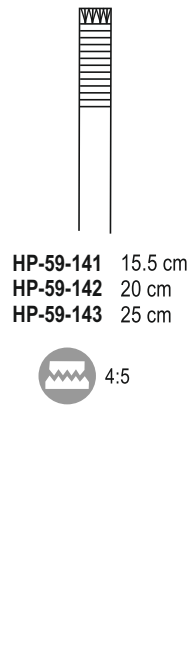

HP-59-141 15.5 cm
HP-59-142 20 cm
HP-59-143 25 cm

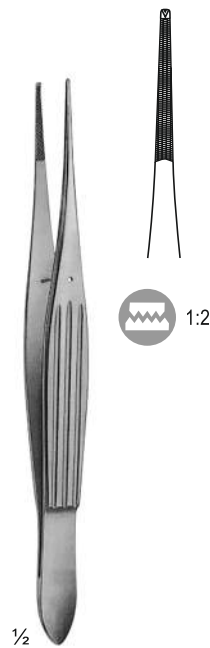

McIndoe
HP-59-144
15 cm

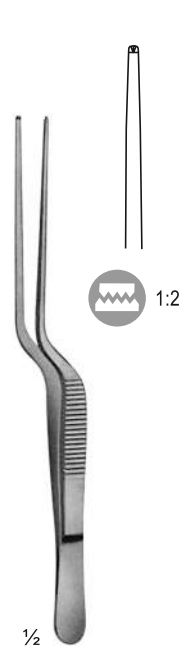

Lucae
HP-59-145
14 cm
Boyonet

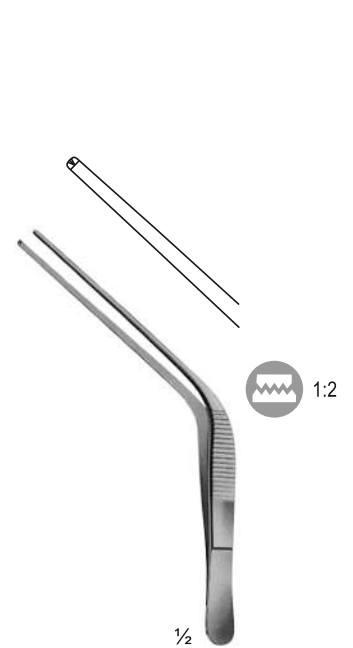

Tröeltsch
HP-59-146
11 cm

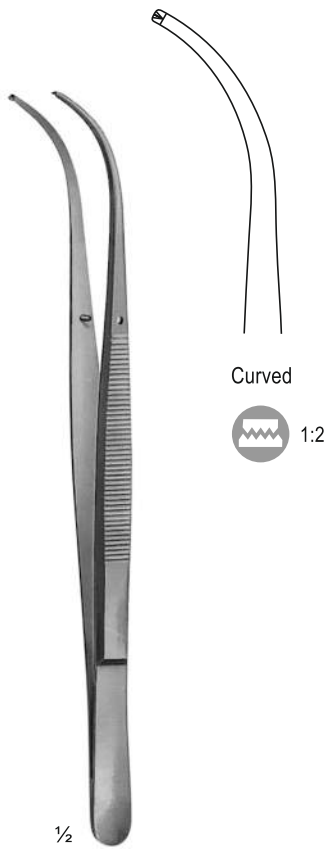

Brophy
HP-60-147
20 cm

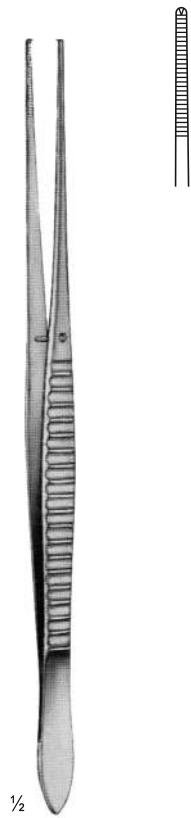

Waugh
HP-60-148
20.5 cm

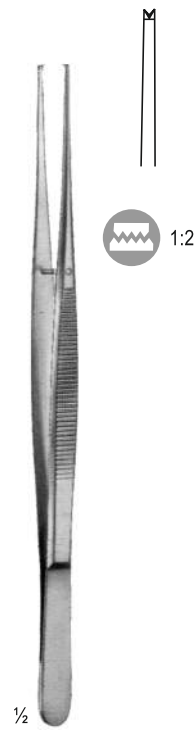

Taylor
HP-60-149
17.5 cm

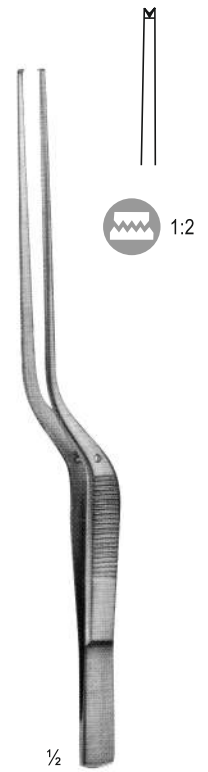

Taylor
HP-60-150
18.5 cm
With dissector end

Tissue Forceps, Dissecting Forceps
Gewebebinzetten, Präparierpinzetten
Pinça de tecido, fórceps dissecante
Pinzas de tejido, pinzas de disección

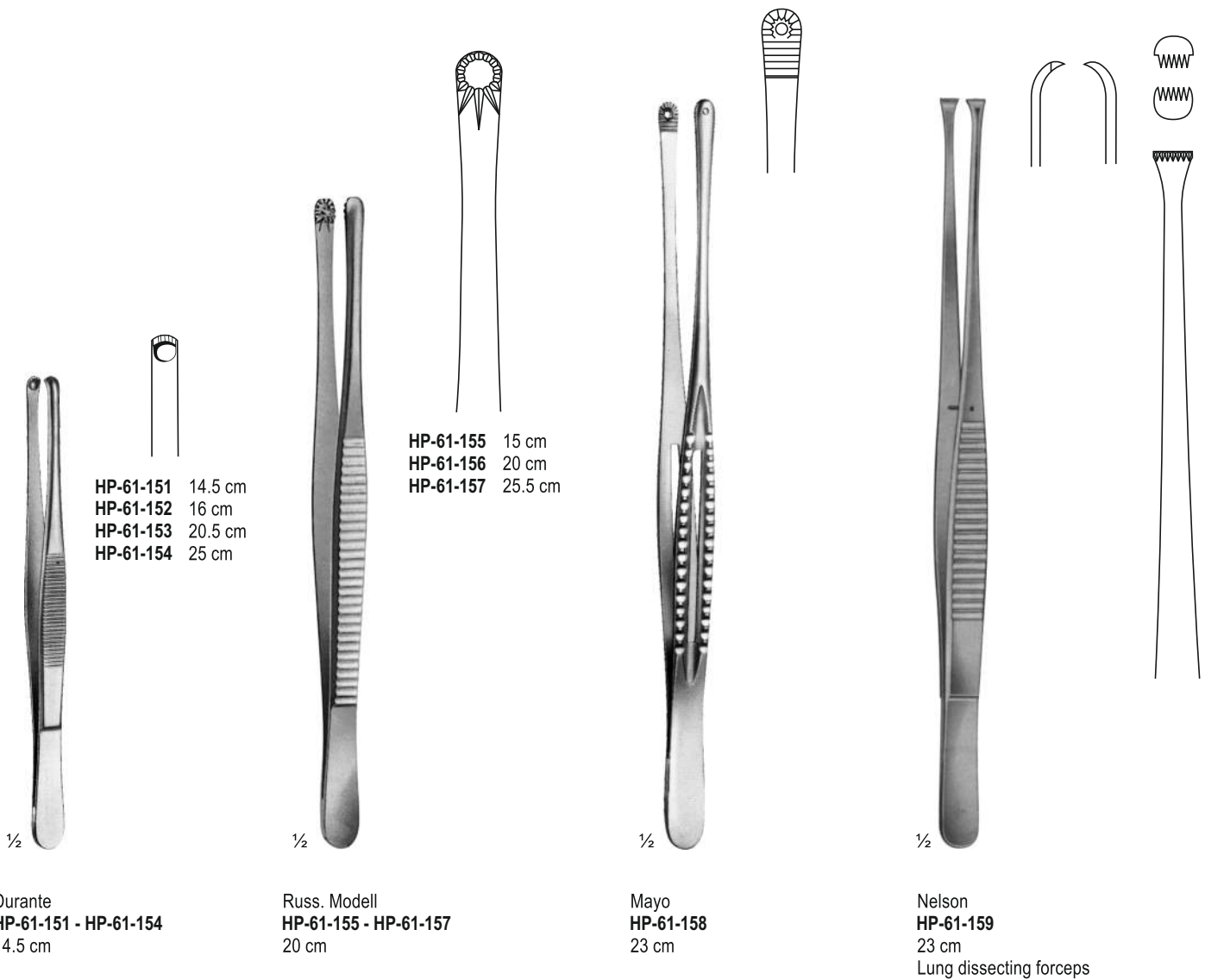

Durante
HP-61-151 - HP-61-154
14.5 cm

Russ. Modell
HP-61-155 - HP-61-157
20 cm

Mayo
HP-61-158
23 cm

Nelson
HP-61-159
23 cm
Lung dissecting forceps

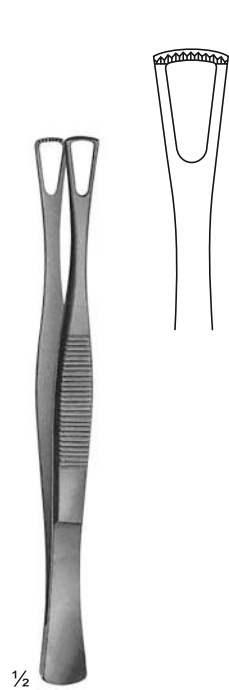

1/2
 Duval
HP-62-160
 14.5 cm
 Intestinal forceps

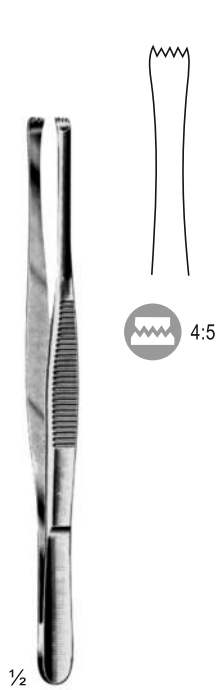

1/2
 Stone
HP-62-161
 15 cm

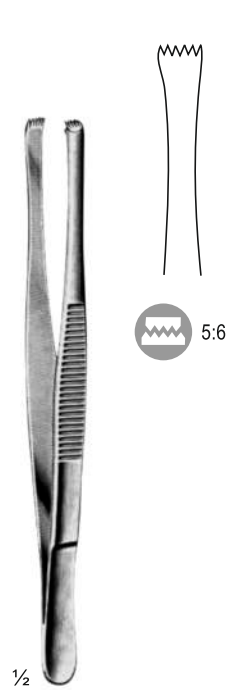

1/2
 Lerche
HP-62-162
 15 cm

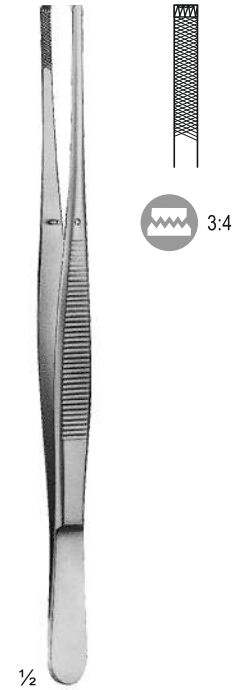

1/2
 Stille-Barraya
HP-62-163
 18 cm

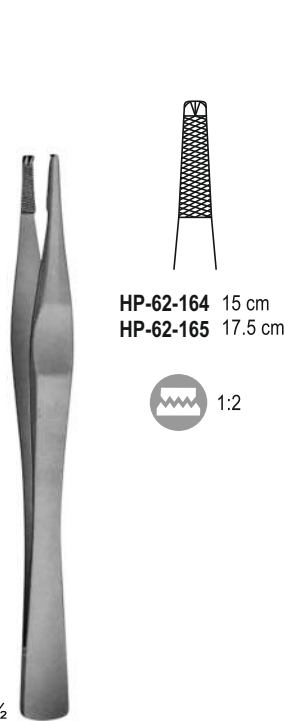

1/2
 Lane
HP-62-164 - HP-62-165
 15 cm

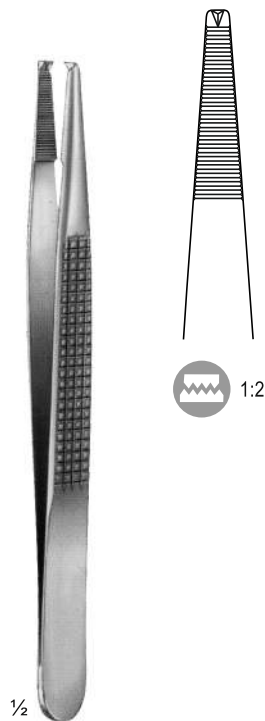

1/2
 Bonney
HP-62-166
 17.5 cm

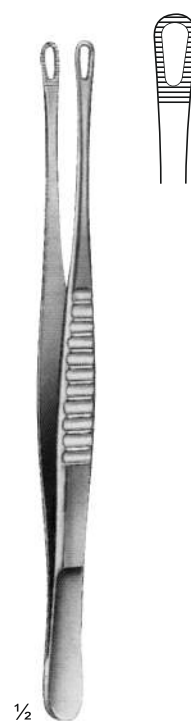

1/2
 Singley-Tuttle
HP-62-167
 18 cm



1/2
 Denis-Browne
HP-62-168
 19 cm
 Intestinal forceps

Micro, Tissue Forceps

Mikro-, Gewebzange
Micro, pinça de tecido
Micro, pinzas de tejido

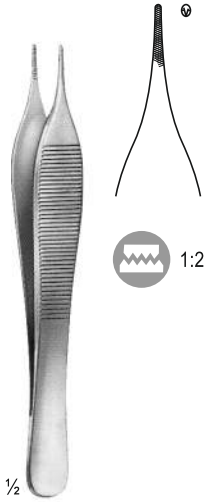

Mini-Adson
HP-63-169
12 cm

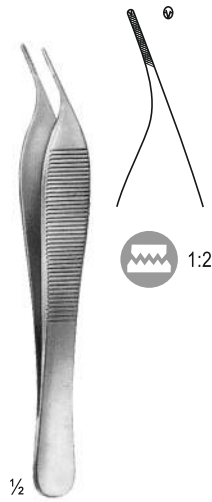

Mini-Adson
HP-63-170
12 cm

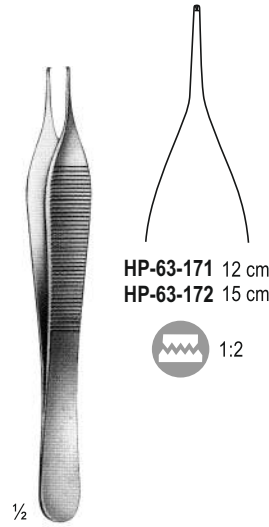

Micro-Adson
HP-63-171 - HP-63-172
12 cm



Adson-Brown
HP-63-173
12 cm

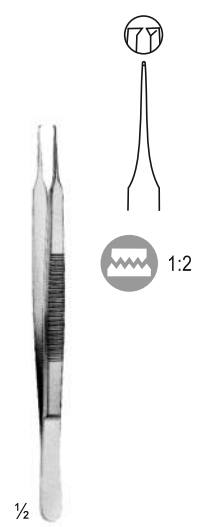

HP-63-174
10.5 cm
very fine teeth

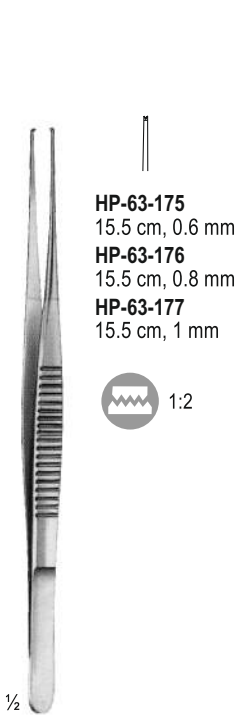

Micro
HP-63-175 - HP-63-177
15.5 cm, 0.6 mm



Cushing
HP-63-178
18 cm

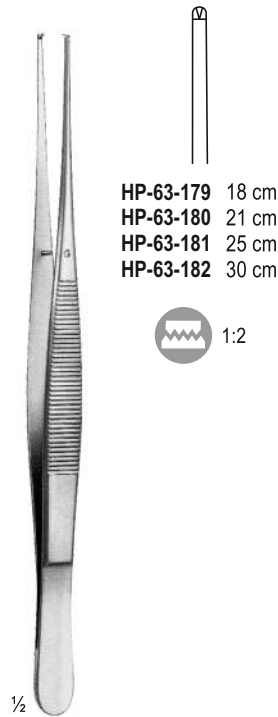

Potts-Smith
HP-63-179 - HP-63-182
18 cm

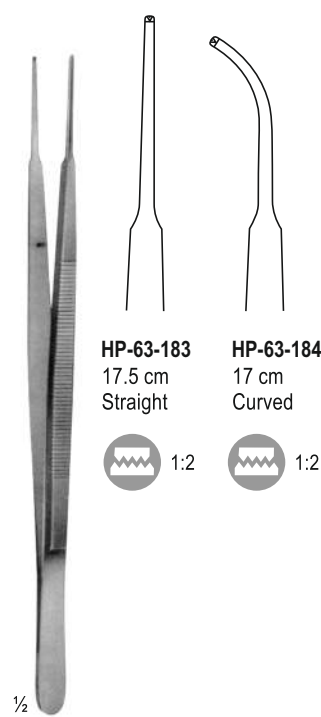

Gerald
HP-63-183 - HP-63-184
17.5 cm

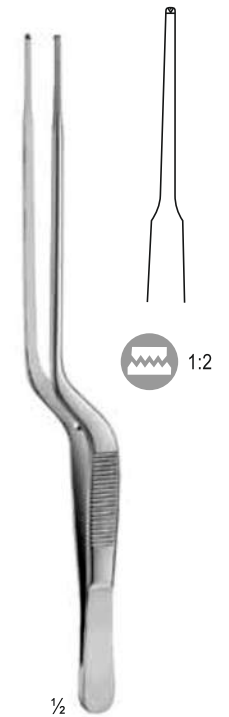

Gerald
HP-63-185
18 cm

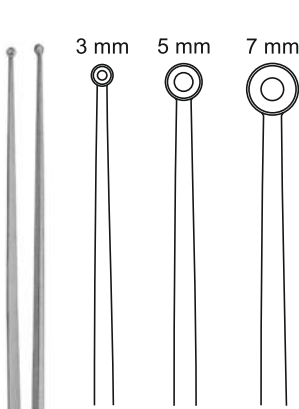

Heifetz
 Curette jaws, toothed
HP-64-186 - HP-64-190
HP-64-186 22 cm 3 mm
HP-64-187 22 cm 5 mm
HP-64-188 24 cm 3 mm
HP-64-189 24 cm 5 mm
HP-64-190 24 cm 7 mm

1/2

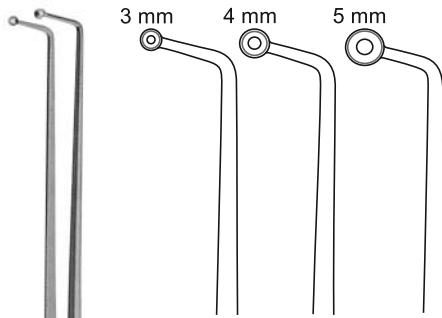

Yasargil-Type
 Spoon-shaped jaws, forward
HP-64-191 - HP-64-193
HP-64-191 23 cm 3mm
HP-64-192 23 cm 4mm
HP-64-193 23 cm 5mm

1/2

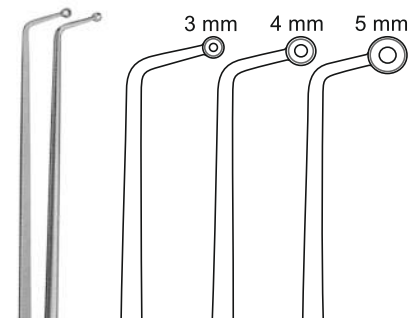

Yasargil-Type
 Spoon-shaped jaws, reserve
HP-64-194 - HP-64-196
HP-64-194 23 cm 3mm
HP-64-195 23 cm 4mm
HP-64-196 23 cm 5mm

1/2

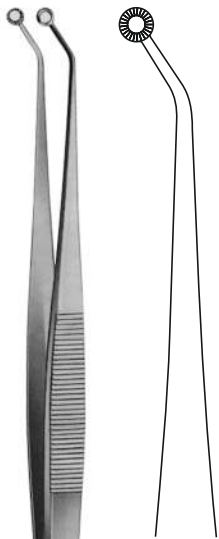

Hunt
HP-64-197
 20 cm
 Tumor-and vessel forceps

1/2

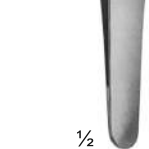
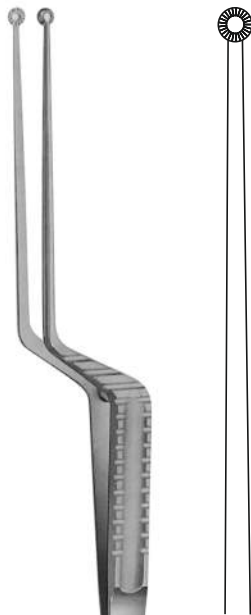

Hunt
HP-64-198
 20 cm
 Tumor-and vessel forceps

1/2



Yasargil
HP-64-199 - HP-64-203
 22 cm
 Tumor-and vessel forceps

1/2

Yasargil-Type Spoon-Shaped Jaws



HP-64-199 22 cm 3 mm
HP-64-200 22 cm 5 mm
HP-64-201 22 cm 7 mm

Yasargil-Type Flat Jaws Serrated



HP-64-202 22 cm 3 mm
HP-64-203 22 cm 5 mm

Ligature Forceps, Micro Forceps (Light Patterns)

Ligaturzange, Mikrozange (Lichtmuster)

Pinça de Ligadura, Micro Pinças (Padrões de Luz)

Pinzas de ligadura, pinzas micro (patrones de luz)



Yasargil
HP-65-204 - HP-65-205
HP-65-204 20 cm 0.6 mm
HP-65-205 20 cm 0.9 mm
Bayonet

Yasargil
HP-65-206 - HP-65-207
HP-65-206 22 cm 0.6 mm
HP-65-207 22 cm 0.9 mm
Bayonet

Yasargil
HP-65-208 - HP-65-209
HP-65-208 24 cm 0.6 mm
HP-65-209 24 cm 0.9 mm
Bayonet

Yasargil
HP-65-210 - HP-65-213
HP-65-210 18 cm
HP-65-211 20 cm
HP-65-212 22 cm
HP-65-213 24 cm
Bayonet

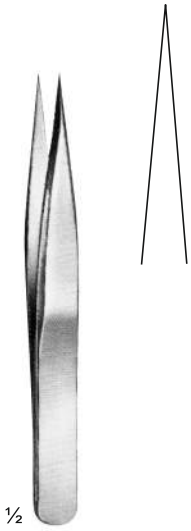

Fig. 3
HP-66-314
 12 cm

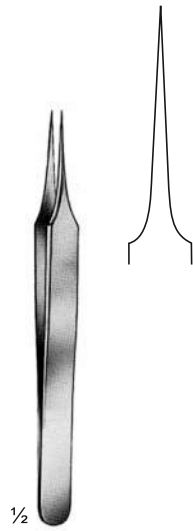

Fig. 4
HP-66-315
 11 cm

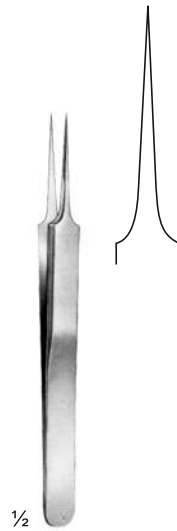

Fig. 5
HP-66-316
 11 cm

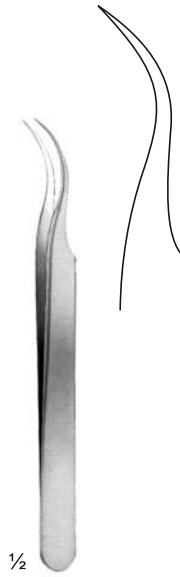
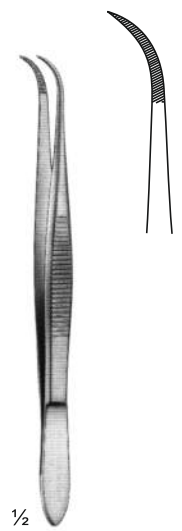

Fig. 7
HP-66-317
 12 cm



HP-66-318
 12.5 cm
 Serrated jaw



HP-66-319 - HP-66-320
HP-66-319 12 cm
HP-66-320 13.5 cm



HP-66-321
 18 cm



HP-66-322
 11 cm



HP-66-323
 11 cm
 with 10° angled
 dilation tips



HP-66-324
 15.5 cm
 Micro tying forceps,
 smooth jaw

Splinter Forceps, Cilia Forceps, Foreign Body Forceps
Splinter-Zange, Cilia-Zange, Former-Baby-Zange
Pinça Splinter, Pinças Cilia, Pinças estrangeiras para bebês
Pinzas astilladas, pinzas cilia, pinzas foráneas para bebês



Stieglitz
HP-67-325 - HP-67-326
Splinter forceps

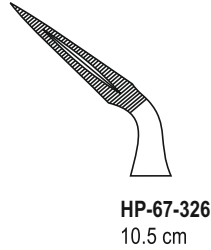
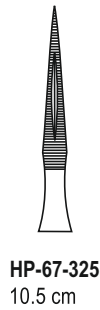

Peet
HP-67-327
12 cm
Splinter forceps

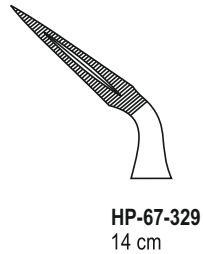
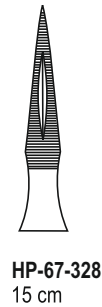

Ralk
HP-67-328 - HP-67-329
14 cm
Splinter forceps



Hunter
HP-67-330
10.5 cm
Splinter forceps

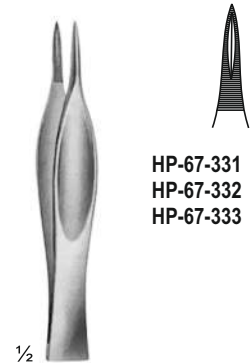

HP-67-331 7.5 cm
HP-67-332 9 cm
HP-67-333 11.5 cm

Feilchenfeld
HP-67-331 - HP-67-333
9 cm
Splinter forceps

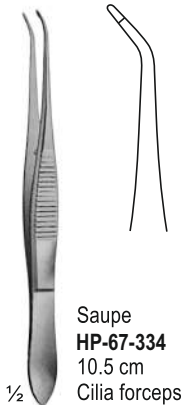

Saupé
HP-67-334
10.5 cm
Cilia forceps



Schaaf
HP-67-335
9.5 cm
Foreign body forceps

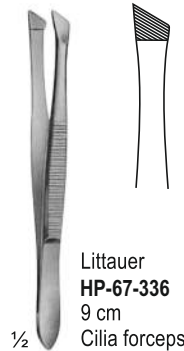

Littauer
HP-67-336
9 cm
Cilia forceps

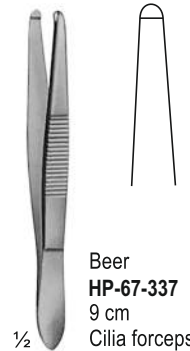

Beer
HP-67-337
9 cm
Cilia forceps

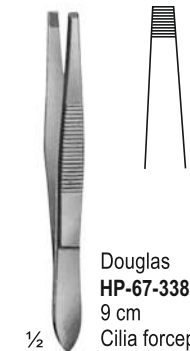

Douglas
HP-67-338
9 cm
Cilia forceps

DISSECTING & TISSUE FORCEPS

03

Dissecting Forceps T.C., Tissue Forceps T.C.
 Spaltpinzette T.C., Gewebepinzette T.C.
 Pinça Dissecante T.C., Pinça de Tecido T.C.
 Disección de fórceps T.C., pinzas de tejido T.C.



 1/2	HP-68-339 14.5 cm HP-68-340 16 cm HP-68-341 18 cm HP-68-342 20 cm HP-68-343 25 cm HP-68-344 30 cm	 1/2	HP-68-345 14.5 cm HP-68-346 16 cm HP-68-347 18 cm HP-68-348 20 cm HP-68-349 25 cm HP-68-350 30 cm	 1/2	HP-68-351 12.5 cm HP-68-352 15 cm	 1/2	HP-68-353 15 cm HP-68-354 23 cm HP-68-355 25 cm
Standard HP-68-339 - HP-68-344 14.5 cm		Standard HP-68-345 - HP-68-350 14.5 cm		Narrow HP-68-351 - HP-68-352 12.5 cm		Wangensteentype HP-68-353 - HP-68-355 15 cm	

 1/2	HP-68-356 12 cm HP-68-357 15 cm HP-68-358 12 cm HP-68-359 15 cm	 1/2	HP-68-360 12 cm HP-68-361 12 cm	 1/2	 1/2
Adson HP-68-356 - HP-68-359 15 cm		Micro Adson HP-68-360 - HP-68-361 12 cm		Adson-brown HP-68-362 12 cm	Semken Normal HP-68-363 16 cm HP-68-364 18 cm Semken Mini HP-68-365 16 cm HP-68-366 18 cm

Dissecting Forceps T.C., Tissue Forceps T.C.

Spaltpinzette T.C., Gewebepinzette T.C.
Pinça Dissecante T.C., Pinça de Tecido T.C.
Disección de fórceps T.C., pinzas de tejido T.C.

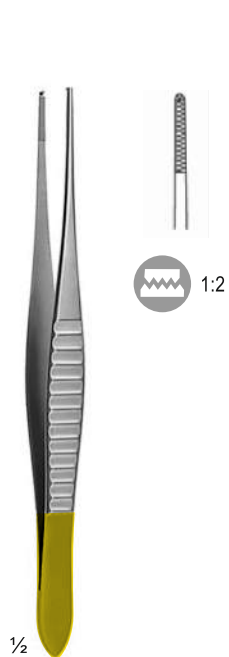

Gillies
HP-69-367
15 cm



McIndoe
HP-69-368
15 cm

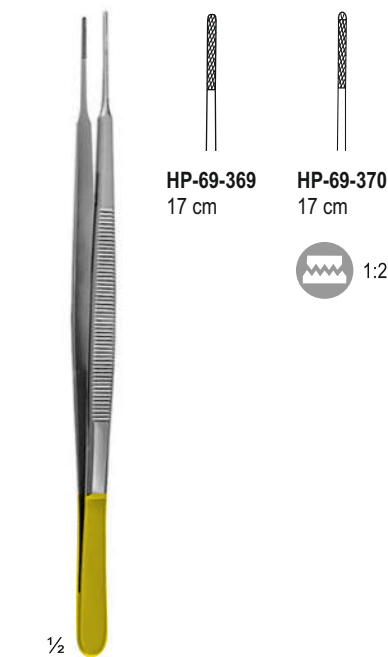

Gerald
HP-69-369 - HP-69-370

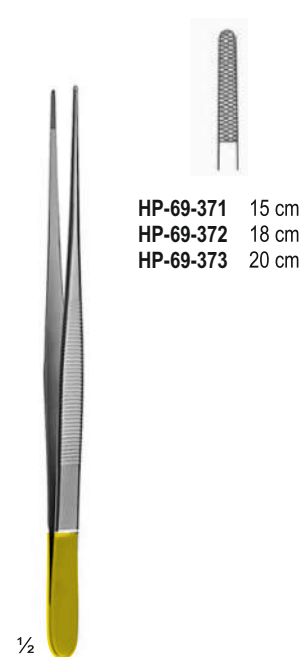

Potts-Smith
HP-69-371 - HP-69-373
15 cm

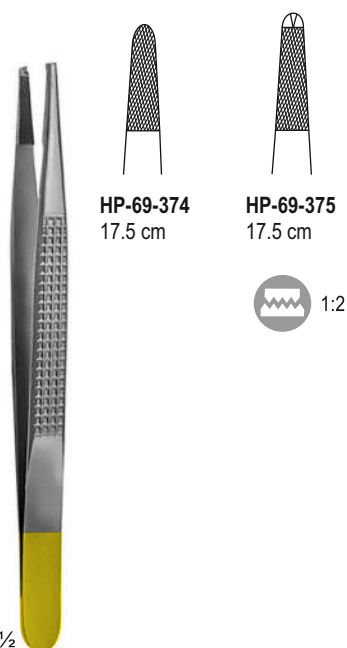

Bonney
HP-69-374 - HP-69-375

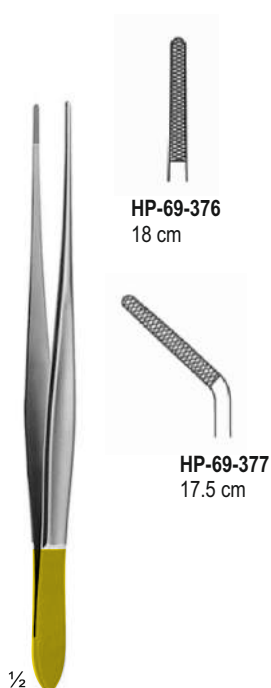

Cushing
HP-69-376 - HP-69-377
17.5 cm



Cushing-Taylor
HP-69-378
18 cm

Oehler
HP-69-379 - HP-69-384
14 cm

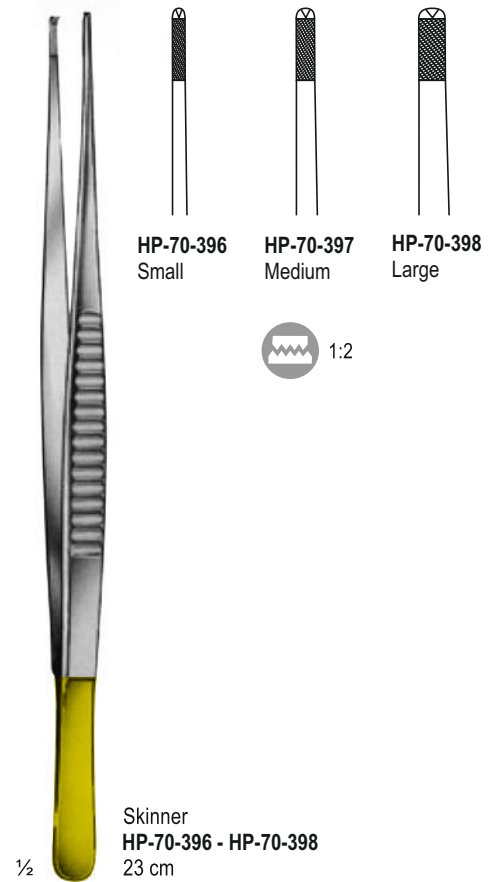
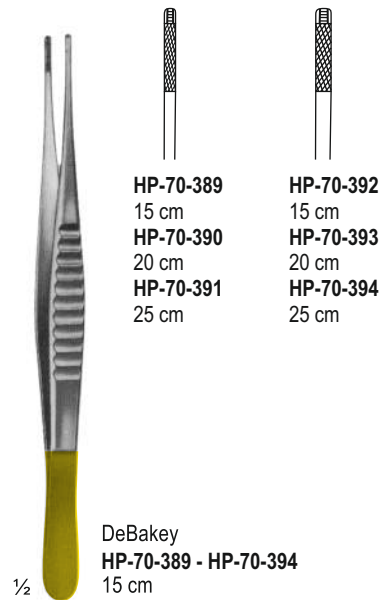
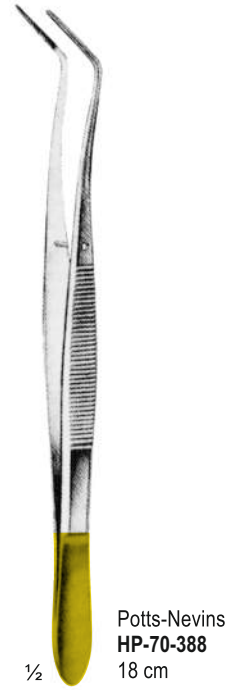
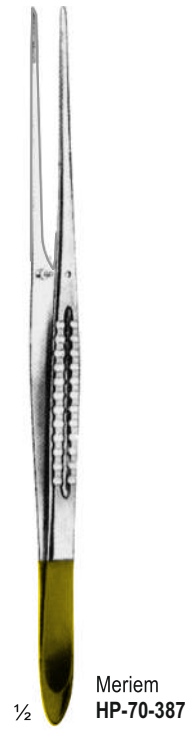

04

Artery Forceps

Arterienzange

Pinça de artéria

Pinzas arteriales

Page 72-106

Bulldog Clamps
Bulldogklammern
Braçadeiras de Buldogue
Bulldog abrazaderas

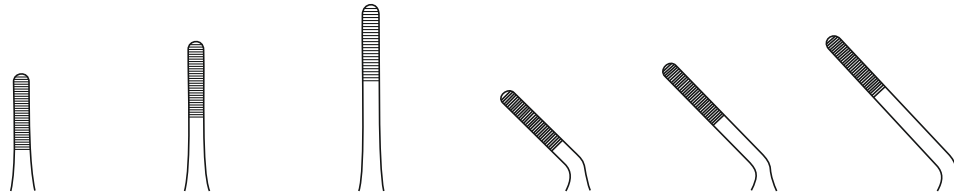

St	HP-72-001	HP-72-002	HP-72-003	HP-72-004	HP-72-005	HP-72-006
mm	31 mm	35 mm	39 mm	30 mm	33 mm	36 mm
mm	10 mm	10 mm	10 mm	10 mm	10 mm	10 mm

HP-72-001 - HP-72-006
Extra light



St	HP-72-007	HP-72-008	HP-72-009	HP-72-010	HP-72-011	HP-72-012
cm	6 cm	6 cm	3,5 cm	5 cm	3,5 cm	5 cm

Dieffenbach
HP-72-008 - HP-72-012

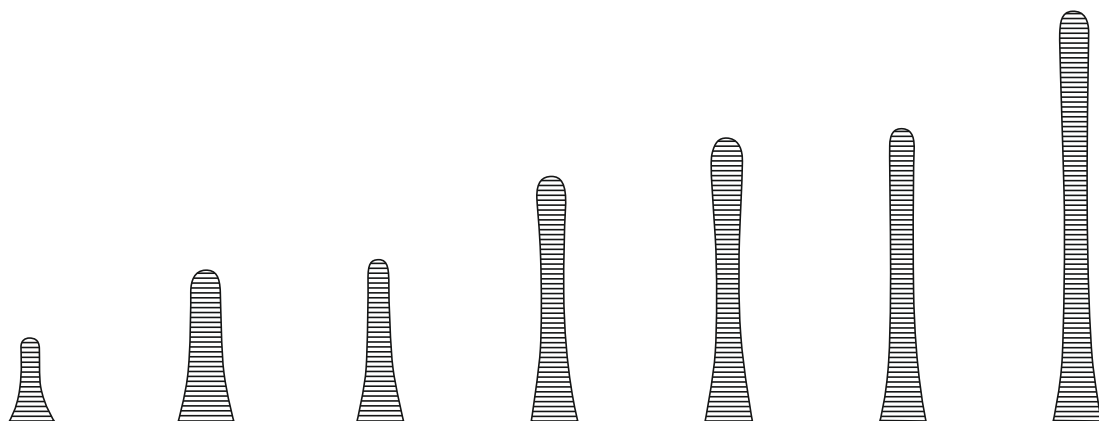

St	HP-72-013	HP-72-014	HP-72-015	HP-72-016	HP-72-017	HP-72-018	HP-72-019
cm	3,8 cm	4,5 cm	5,5 cm	6,5 cm	7 cm	7,5 cm	9 cm

Johns-Hopkins
HP-72-013 - HP-72-019



Johns-Hopkins
HP-73-020 - HP-73-026

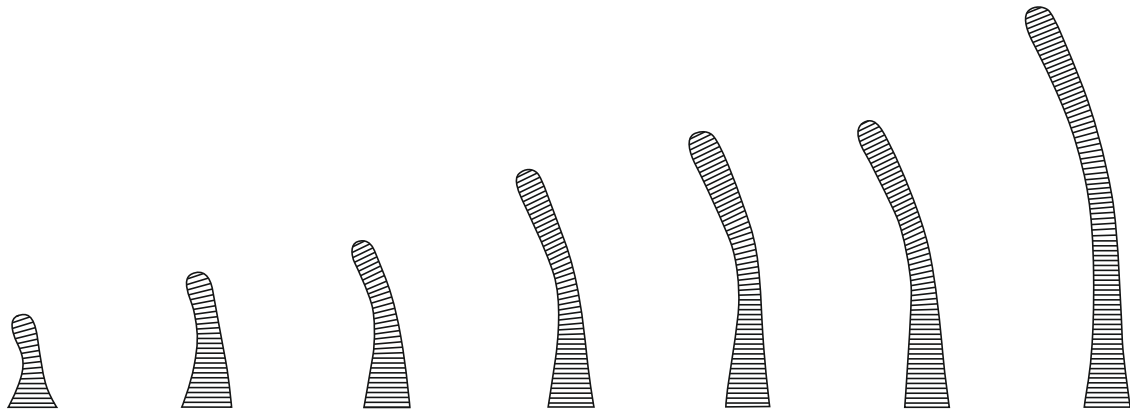

St	HP-73-020	HP-73-021	HP-73-022	HP-73-023	HP-73-024	HP-73-025	HP-73-026
HP	3.8 cm	4.5 cm	5.5 cm	6.5 cm	7 cm	7.5 cm	9 cm



Diethrich
HP-73-027 - HP-73-032

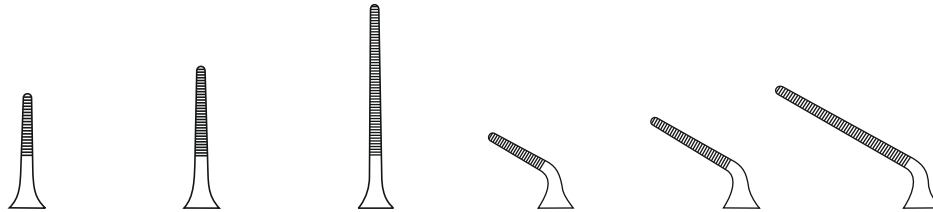

St	HP-73-027	HP-73-028	HP-73-029	HP-73-030	HP-73-031	HP-73-032
HP	45 mm	50 mm	60 mm	40 mm	45 mm	50 mm
U	8 mm	12 mm	20 mm	8 mm	12 mm	20 mm

ATRAUMA



DeBakey-Diethrich
HP-73-033 - HP-73-044

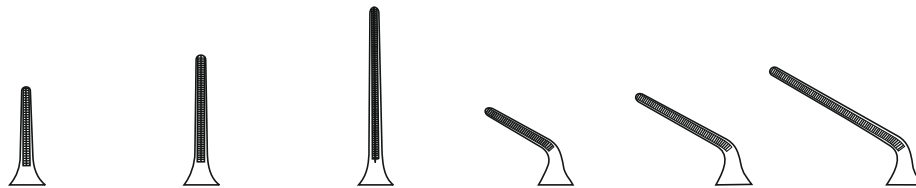

St	HP-73-033	HP-73-034	HP-73-035	HP-73-036	HP-73-037	HP-73-038
Ti	HP-73-039	HP-73-040	HP-73-041	HP-73-042	HP-73-043	HP-73-044
HP	45 mm	50 mm	60 mm	35 mm	45 mm	50 mm
U	10 mm	14 mm	20 mm	10 mm	14 mm	20 mm

Bulldog Clamps
Bulldogklammern
Braçadeiras de Buldogue
Bulldog abrazaderas

ATRAUMA



DeBakey
HP-74-045 - HP-74-052



St	HP-74-045	HP-74-046	HP-74-047	HP-74-048
Ti	HP-74-049	HP-74-050	HP-74-051	HP-74-052
HP	7.5 cm	8.5 cm	10 cm	12 cm



DeBakey
HP-74-053 - HP-74-060

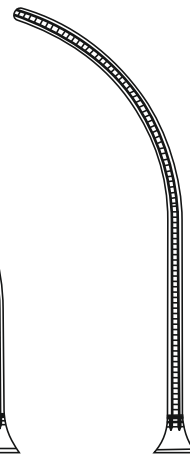
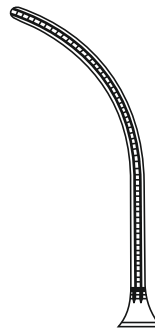
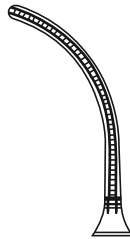
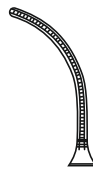

St	HP-74-053	HP-74-054	HP-74-055	HP-74-056
Ti	HP-74-057	HP-74-058	HP-74-059	HP-74-060
HP	7.5 cm	8.5 cm	10 cm	12 cm

ARTERY FORCEPS

04

Haemostatic Forceps, Dissecting and Ligature Forceps
 Hämostatische Pinzetten, Präparier- und Ligaturzangen
 Pinça Hemostática, Pinça de Dissecção e Ligadura
 Pinzas hemostáticas, disección y pinzas de ligadura

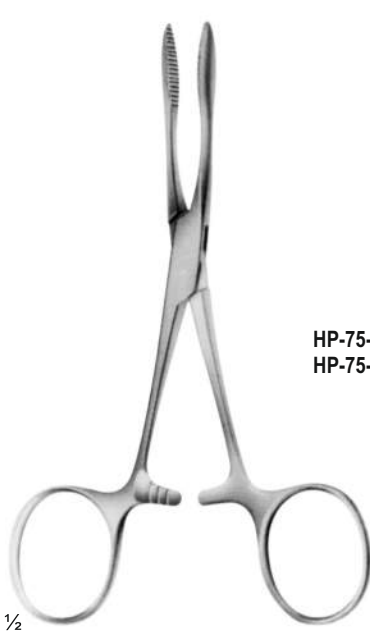

HP-75-061 14,5 cm
 HP-75-062 16 cm

1/2

Pean
 HP-75-061 - HP-75-062
 16 cm

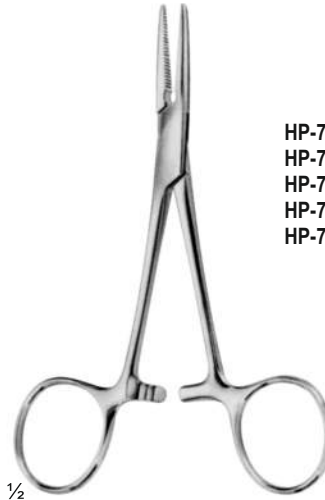

1/2

Spencer-Wells
 HP-75-063 - HP-75-072
 13 cm



HP-75-063 13 cm
 HP-75-064 14.5 cm
 HP-75-065 15.5 cm
 HP-75-066 18.5 cm
 HP-75-067 20 cm



HP-75-068 13 cm
 HP-75-069 14 cm
 HP-75-070 15 cm
 HP-75-071 18 cm
 HP-75-072 20 cm

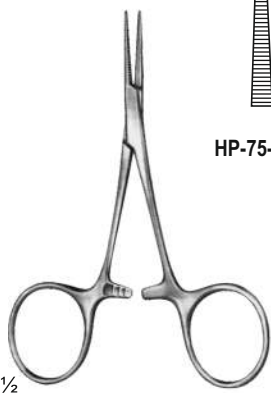

1/2

Hartmann
 HP-75-073 - HP-75-074
 10 cm



HP-75-073

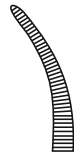

HP-75-074



1/2

Mixer-Baby
 HP-75-075 - HP-75-077
 13.5 cm
 Dissecting & ligature forceps



HP-75-075
 13.5 cm

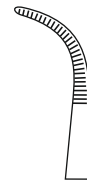

HP-75-076
 13 cm



1/2

Schwartz
 HP-75-078
 20 cm
 Bulldog applying forceps

Haemostatic Forceps, Organ Grasping Forceps
Hämostatische Pinzetten, Organfaßzangen
Pinça hemostática, pinça de apreensão de órgãos
Pinzas hemostáticas, fórceps de agarre de órganos

ATRAUMA



HP-76-079 - HP-76-080
25 cm
Organ grasping forceps



HP-76-079
25 cm

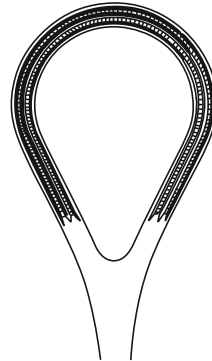

HP-76-080
26 cm

1/2

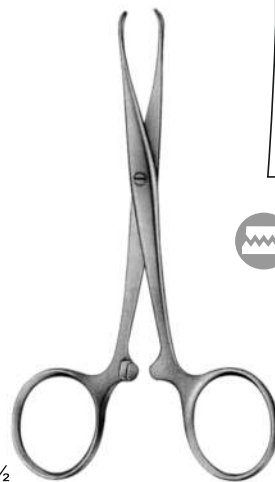

Chaput
HP-76-081
12.5 cm
2 X 3 teeth, sharp



1/2

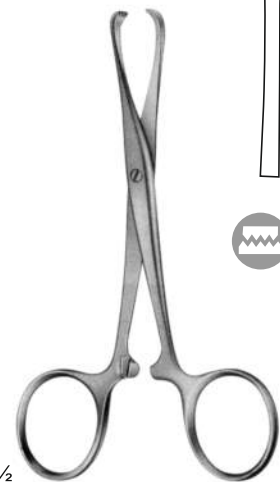

Tuffier
HP-76-082
12.5 cm
5 X 6 teeth, sharp



1/2

ARTERY FORCEPS

04

Haemostatic Forceps, Organ Grasping Forceps, Face Lift Forceps
 Hämostatische Pinzette, Organ-fassende Pinzette, Facelift-Pinzette
 Pinça Hemostática, Pinça de Apreensão de Órgãos, Pinça de Levantamento Facial
 Pinzas hemostáticas, fórceps de agarre de órgãos, fórceps de estiramiento facial

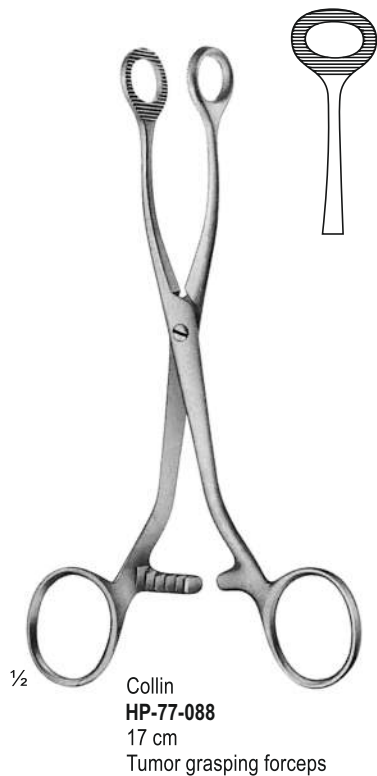
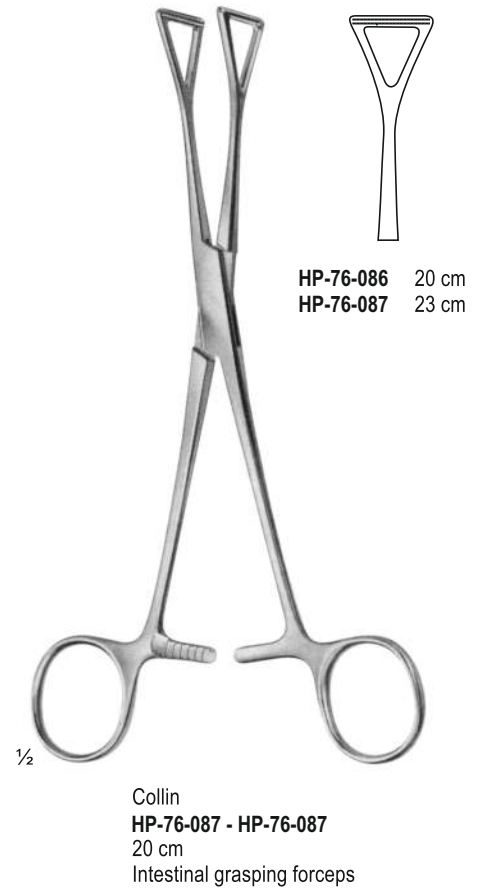
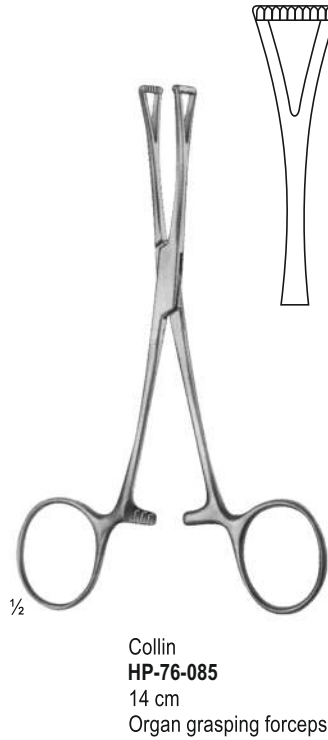
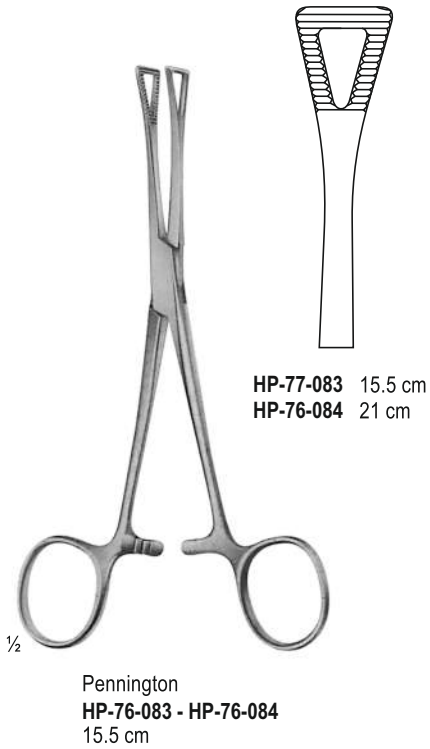

Haemostatic Forceps
Hämostatische Pinzetten
Pinça hemostática
Pinzas hemostáticas



½

Halsted-Mosquito
HP-78-091 - HP-78-098
14 cm



HP-78-091 12.5 cm
HP-78-092 14 cm



HP-78-093 12.5 cm
HP-78-094 14 cm



HP-78-095 12.5 cm
HP-78-096 14 cm



HP-78-097 12.5 cm
HP-78-098 14 cm



½

Halsted-Mosquito
HP-78-099 - HP-78-106
18 cm



HP-78-099 18 cm
HP-78-100 21 cm

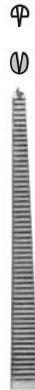

HP-78-101 18 cm
HP-78-102 21 cm



HP-78-103 18 cm
HP-78-104 21 cm

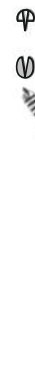

HP-78-105 18 cm
HP-78-106 21 cm





HP-79-107
14 cm



HP-79-108
13.5 cm

1/2
Providence-Hospital
HP-79-107 -HP-79-108
14 cm



HP-79-109
15.5 cm

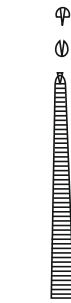

HP-79-110
15 cm



HP-79-111
15.5 cm

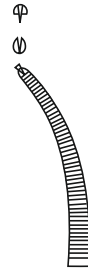

HP-79-112
15 cm

1/2
Leriche
HP-79-109 -HP-79-112
15.5 cm



HP-79-113



HP-79-114

1/2
Kelly
HP-79-113 - HP-79-114
14 cm



Dunhill
HP-79-115
12.5 cm

1/2



Dunhill
HP-79-116
18.5 cm

1/2

Haemostatic Forceps
Hämostatische Pinzetten
Pinça hemostática
Pinzas hemostáticas

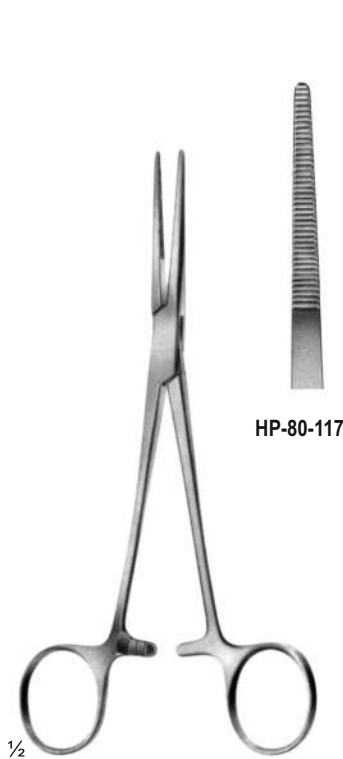

HP-80-117

HP-80-118

Kelly-Rankin
HP-80-117 - HP-80-118
16 cm



HP-80-119

HP-80-120

Lovlace
HP-80-119 - HP-80-120
16 cm



1/2

Obwegeser
HP-80-121
19 cm



HP-80-122

HP-80-123

Crile-Rankin
HP-80-122 - HP-80-123
16 cm

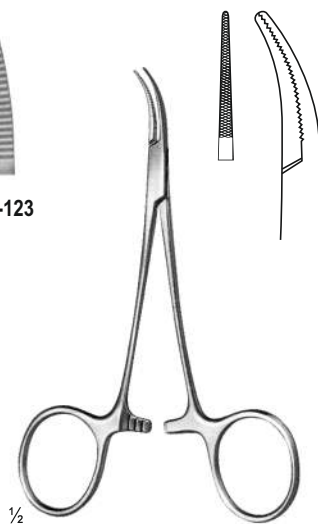

1/2

Dandy-Mosquito
HP-80-124
12 cm
Laterally curved



1/2

Dandy
HP-80-125 - HP-80-126
14.5 cm
Laterally curved

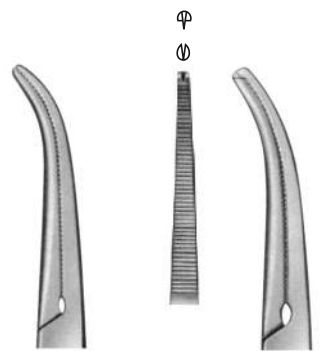

HP-80-125
14.5 cm

HP-80-126
14.5 cm



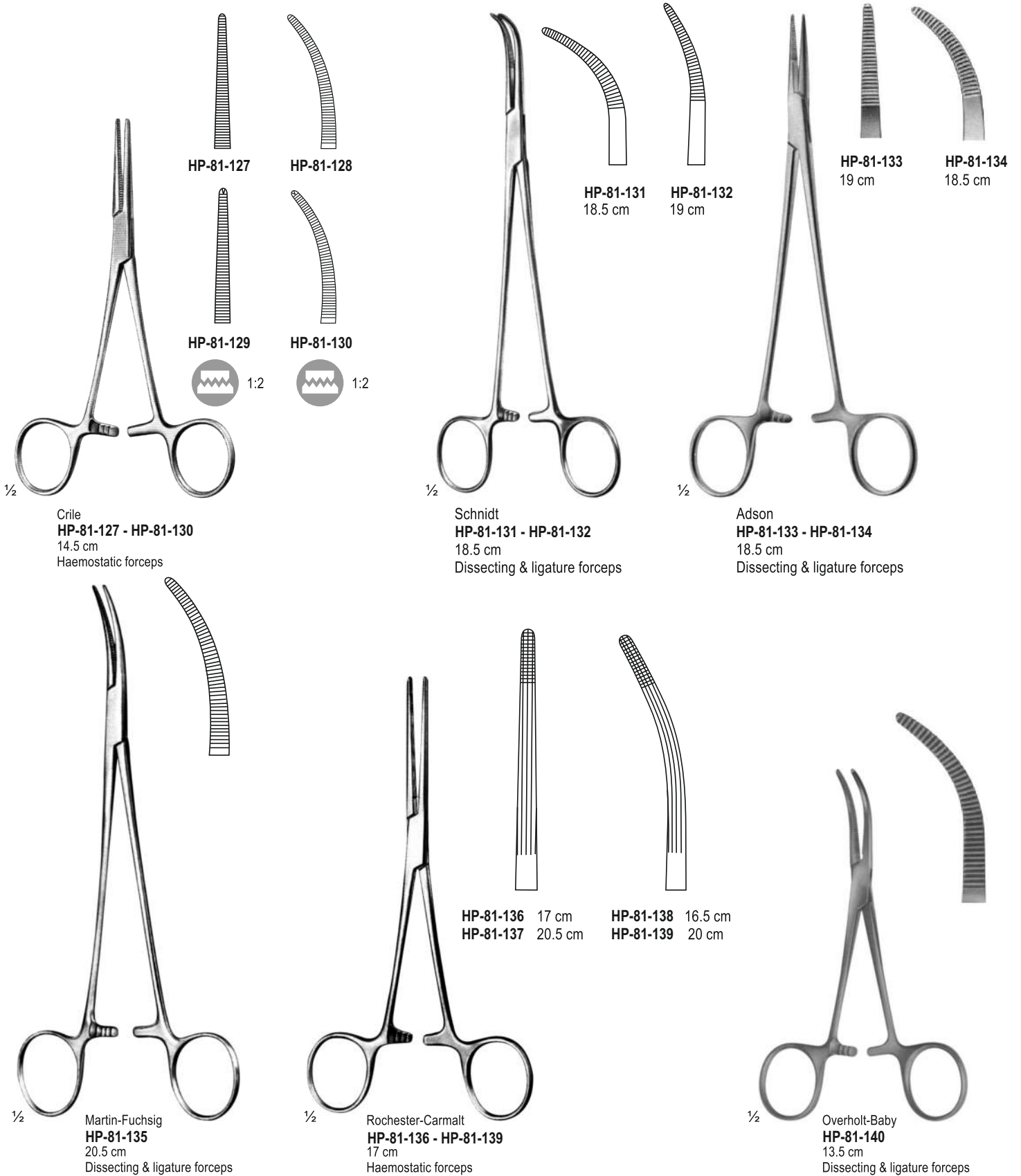

Haemostatic Forceps
Hämostatische Pinzetten
Pinça hemostática
Pinzas hemostáticas



Pean
HP-82-141 - HP-82-146
17 cm



HP-82-141 13.5 cm
HP-82-142 14.5 cm
HP-82-143 17 cm



HP-82-144 13 cm
HP-82-145 14 cm
HP-82-146 16.5 cm

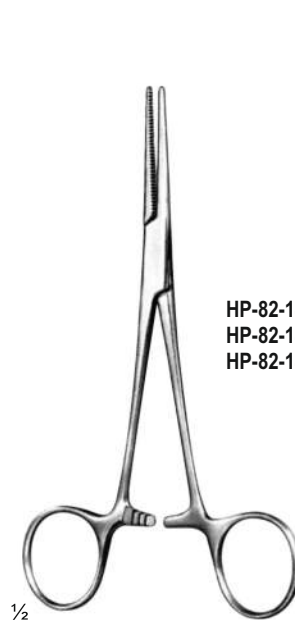

Pean-Nippon
HP-82-147 - HP-82-152
14.5 cm



HP-82-147 14.5 cm
HP-82-148 16.5 cm
HP-82-149 18.5 cm

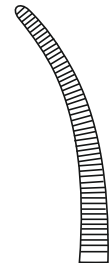

HP-82-150 14 cm
HP-82-151 16 cm
HP-82-152 18 cm



Kocher
HP-82-153 - HP-82-158
14 cm



HP-82-153 13 cm
HP-82-154 14 cm
HP-82-155 16 cm



HP-82-156 13 cm
HP-82-157 14 cm
HP-82-158 16 cm

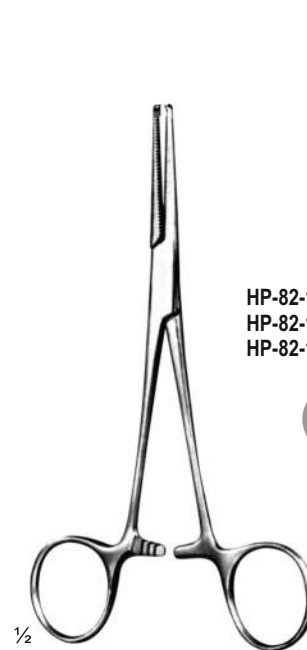

Kocher-Nippon
HP-82-159 - HP-82-164
14.5 cm



HP-82-159 14.5 cm
HP-82-160 16.5 cm
HP-82-161 18.5 cm



HP-82-162 14 cm
HP-82-163 16 cm
HP-82-164 18 cm



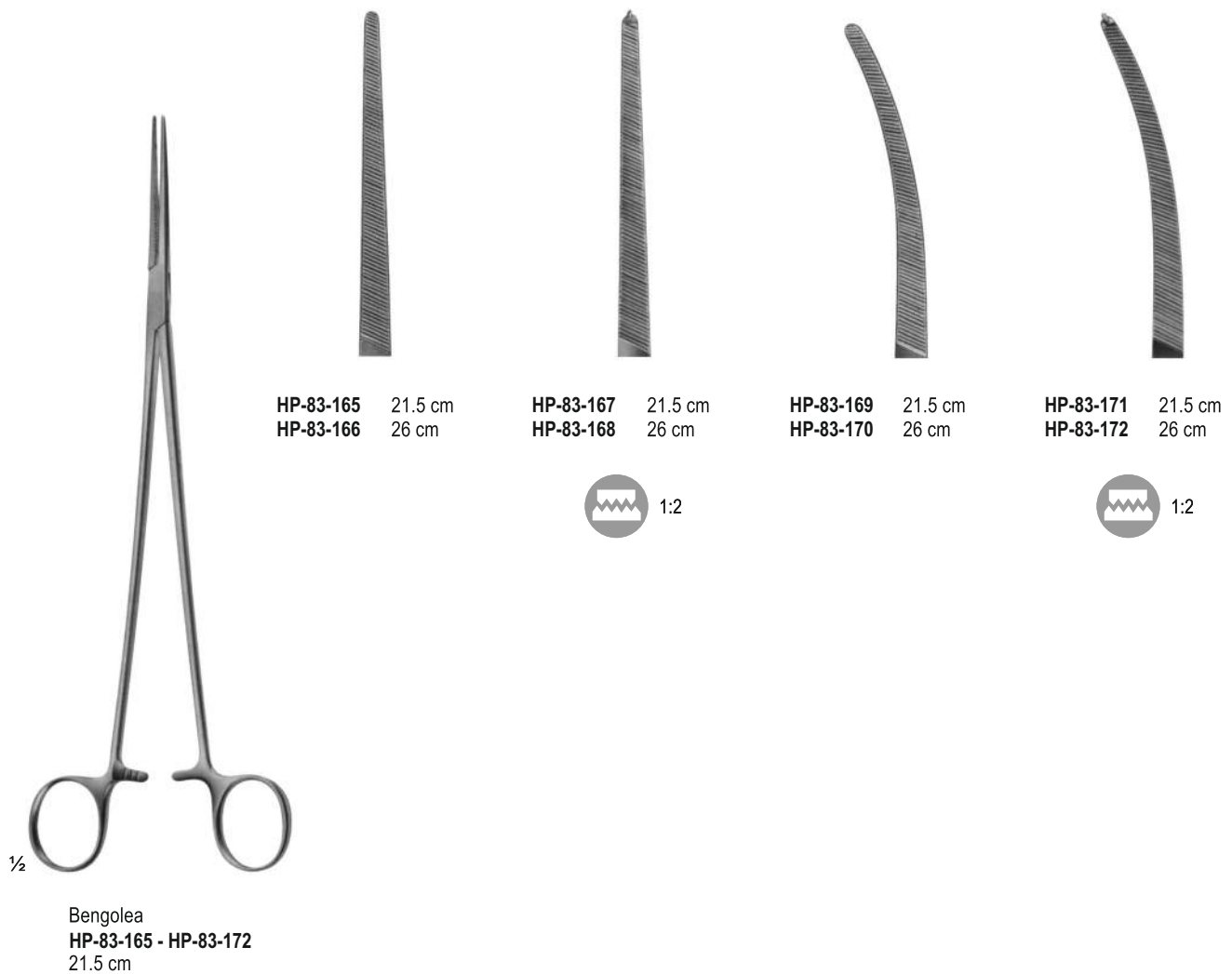

Haemostatic Forceps, Dissecting, Ligature Forceps

Hämostatische Pinzetten, Präparation, Ligaturzange
Pinça Hemostática, Dissecante, Pinça de Ligadura
Pinzas hemostáticas, disección, pinzas de ligadura

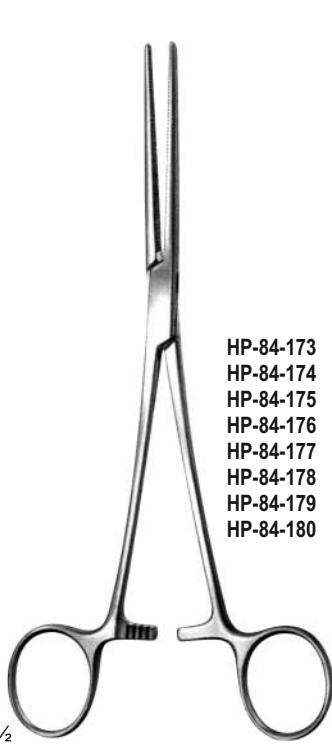

- HP-84-173 14.5 cm
- HP-84-174 16.5 cm
- HP-84-175 18.5 cm
- HP-84-176 20.5 cm
- HP-84-177 22.5 cm
- HP-84-178 24.5 cm
- HP-84-179 26 cm
- HP-84-180 30.5 cm



- HP-84-181 14.5 cm
- HP-84-182 16.5 cm
- HP-84-183 18.5 cm
- HP-84-184 20.5 cm
- HP-84-185 22.5 cm
- HP-84-186 24.5 cm
- HP-84-187 26 cm
- HP-84-188 30.5 cm

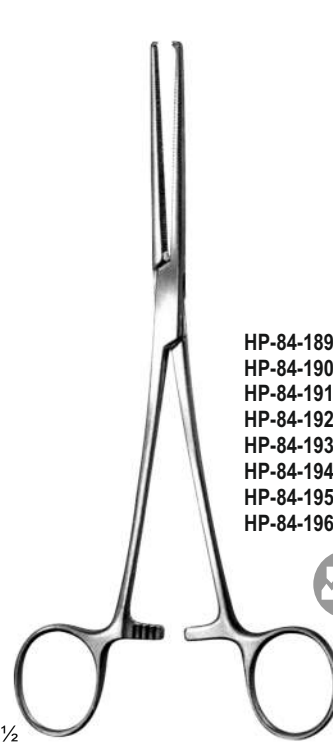

- HP-84-189 14.5 cm
- HP-84-190 16.5 cm
- HP-84-191 18.5 cm
- HP-84-192 20.5 cm
- HP-84-193 22.5 cm
- HP-84-194 24 cm
- HP-84-195 26 cm
- HP-84-196 31 cm

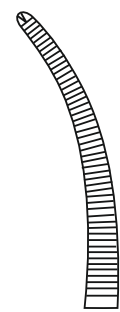

- HP-84-197 14.5 cm
- HP-84-198 16.5 cm
- HP-84-199 18.5 cm
- HP-84-200 20.5 cm
- HP-84-201 22.5 cm
- HP-84-202 24 cm
- HP-84-203 26 cm
- HP-84-204 31 cm



1/2
Pean (Rochester)
HP-84-173 - HP-84-188
18.5 cm
Haemostatic forceps

1/2
Kocher (Ochsner)
HP-84-189 - HP-84-204
18.5 cm
Haemostatic forceps



1/2
Overholt-Martin
HP-84-205 - HP-84-209
18.5 cm
Dissecting & ligature forceps

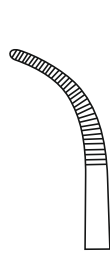

Fig. 1
HP-84-205
18.5 cm

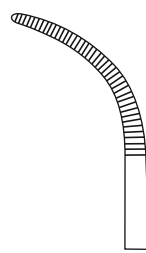

Fig. 2
HP-84-206
20.5 cm

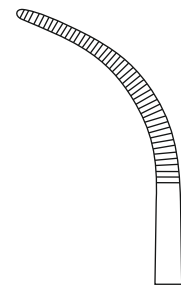

Fig. 3
HP-84-207
21 cm

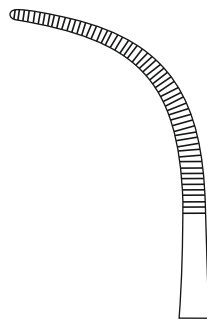

Fig. 4
HP-84-208
21.5 cm

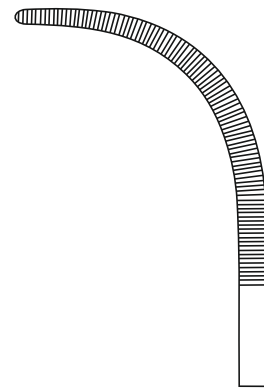

Fig. 5
HP-84-209
24.5 cm



1/2
Mixer-Baby
HP-85-210
 18.5 cm



1/2
Adson-Baby
HP-85-211 - HP-85-212
 18 cm

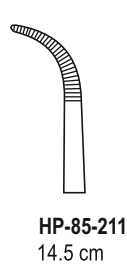

HP-85-211
 14.5 cm

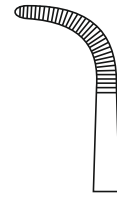

HP-85-212
 18 cm



1/2
Heiss
HP-85-213 - HP-85-215
 21 cm



HP-85-213
 21 cm



HP-85-214
 20.5 cm



HP-85-215
 20 cm



1/2
Overholt-Mixer
HP-85-216
 22 cm

Dissecting, Ligature Forceps
Präparierende Ligaturzange
Dissecando, Pinça de Ligadura
Disección, pinzas de ligadura



HP-86-217
22.5 cm

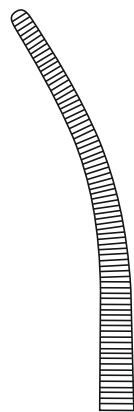

HP-86-218
22 cm

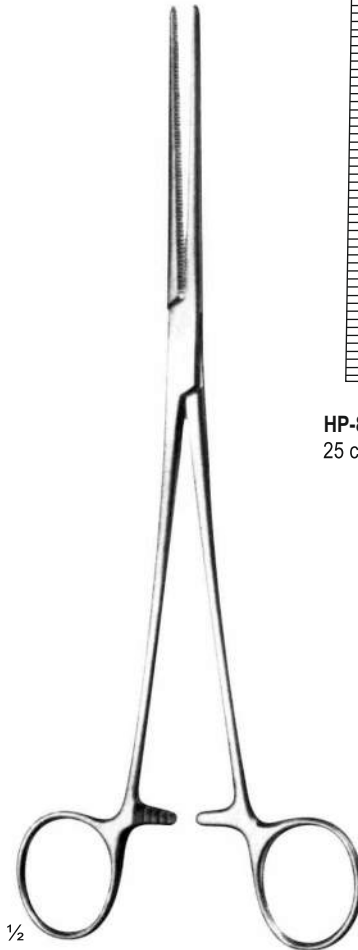

HP-86-219
25 cm

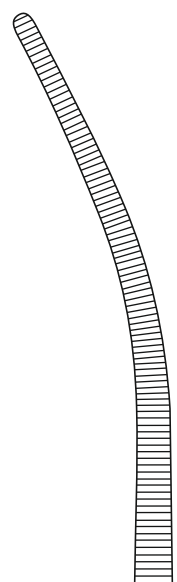

HP-86-220
24.5 cm

Roberts
HP-86-217 -HP-86-218
22.5 cm

Sarot
HP-86-219 -HP-86-220
25 cm



1/2

Crafoord
 HP-87-221 - HP-87-222
 24.5 cm

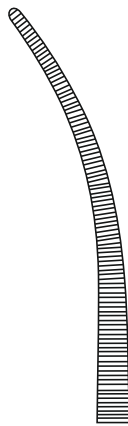

HP-87-221
 18.5 cm

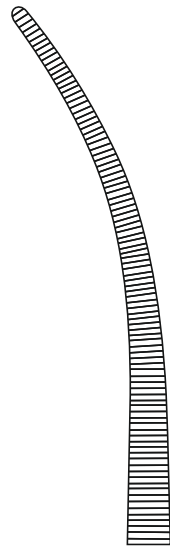

HP-87-222
 24.5 cm



1/2

Crafoord-Sellors
 HP-87-223 - HP-87-225
 24 cm

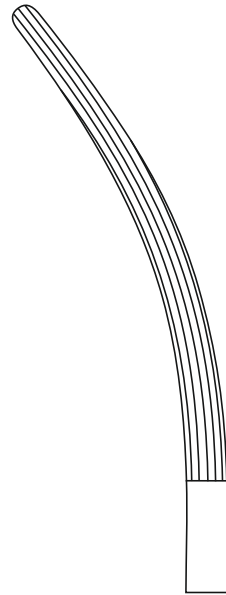

HP-87-223

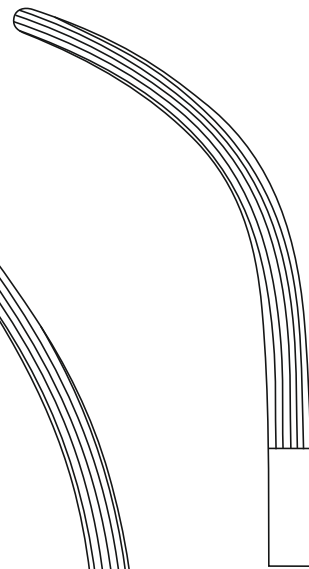

HP-87-224

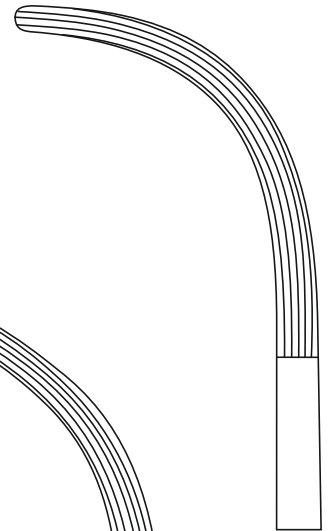

HP-87-225

Dissecting, Ligature Forceps
Präparierende Ligaturzange
Dissecando, Pinça de Ligadura
Disección, pinzas de ligadura

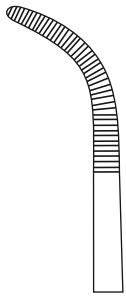

Fig.1
HP-88-226
20.5 cm

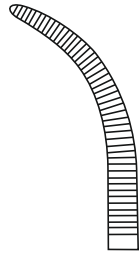

Fig.2
HP-88-227
20 cm

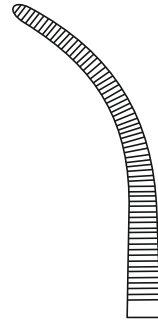

Fig.3
HP-88-228
21.5 cm

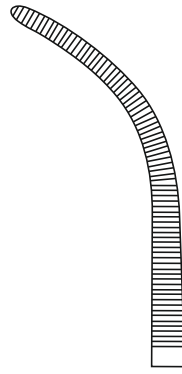

Fig.4
HP-88-229
22 cm

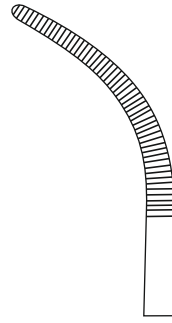

Fig.5
HP-88-230
21.5 cm

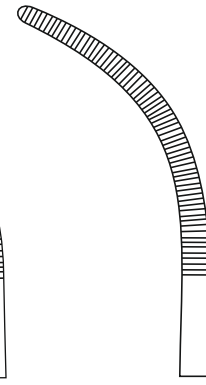

Fig.6
HP-88-231
22 cm

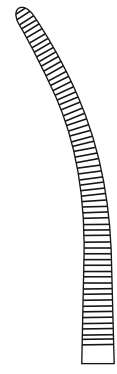

Fig.7
HP-88-232
22 cm



Overholt-Geissendörfer
HP-88-226 - HP-88-239
20.5 cm

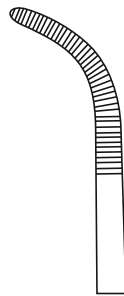

Fig.1
HP-88-233
27 cm

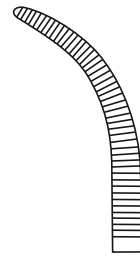

Fig.2
HP-88-234
26.5 cm

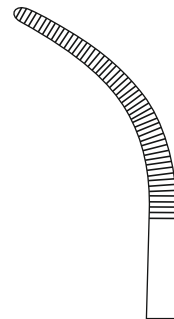

Fig.3
HP-88-235
27.5 cm

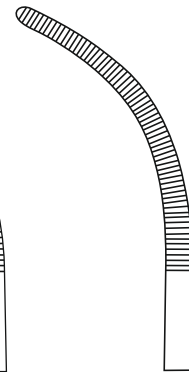

Fig.4
HP-88-236
28 cm

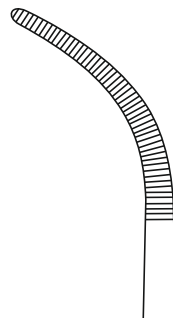

Fig.5
HP-88-237
27.5 cm

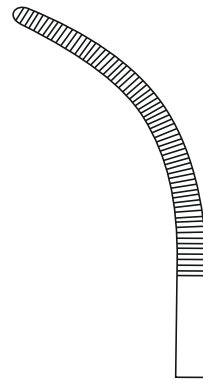

Fig.6
HP-88-238
28 cm



Fig.7
HP-88-239
27.5 cm



Fig.1
HP-89-240
 24 cm

Fig.2
HP-89-241
 24 cm

Fig.3
HP-89-242
 23.5 cm

Fig.4
HP-89-243
 24 cm

Fig.5
HP-89-244
 24 cm

Rumel
HP-89-240 - HP-89-244
 24 cm



Fig.0
HP-89-245
 21.5 cm



Fig.1
HP-89-246
 22 cm



Fig.2
HP-89-247
 22.5 cm



Fig.3
HP-89-248
 23 cm

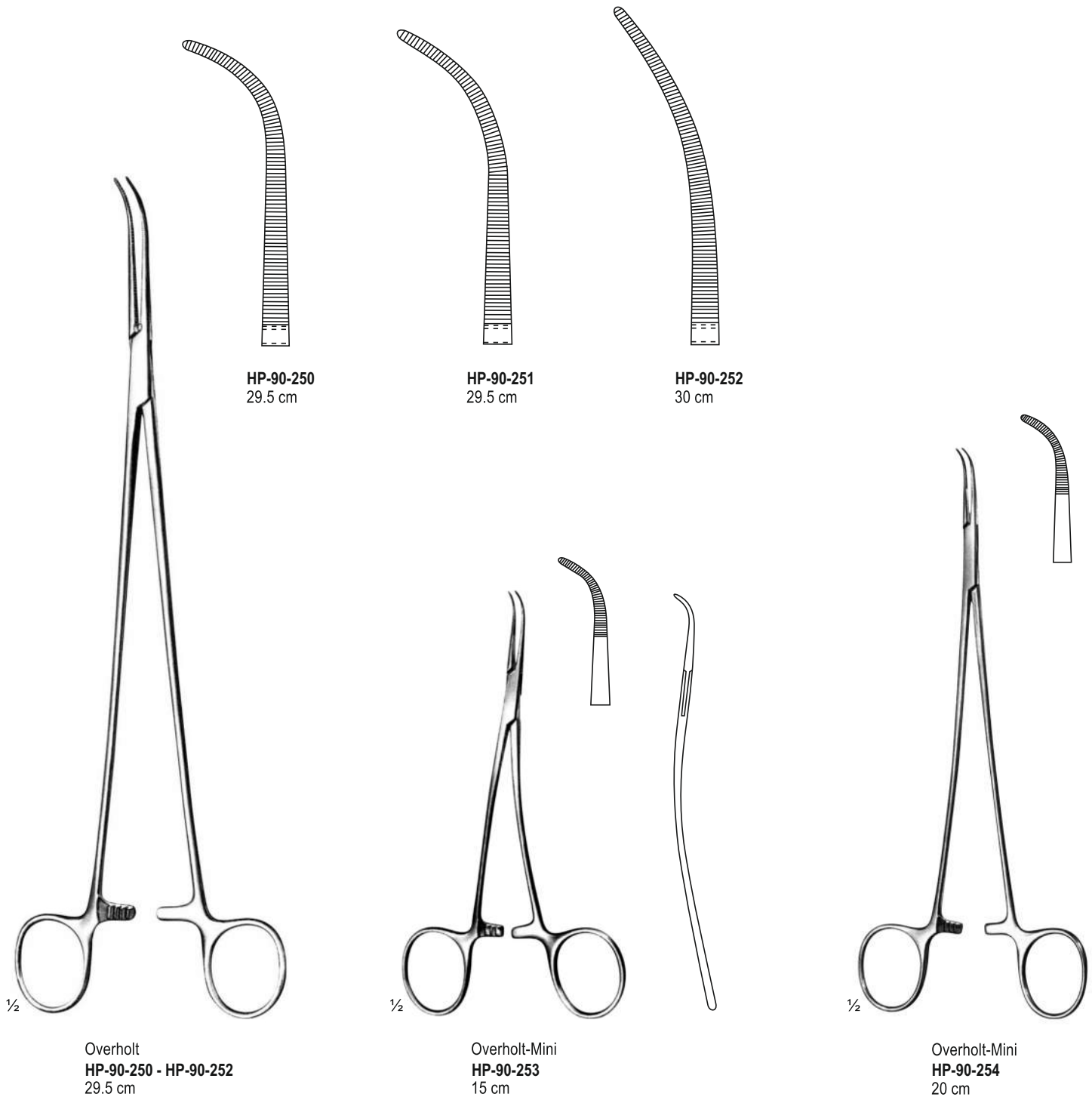

Fig.6
HP-89-249
 22.5 cm

Overholt-Fine
HP-89-245 - HP-89-249
 21.5 cm



Dissecting, Ligature Forceps
Präparierende Ligaturzange
Dissecando, Pinça de Ligadura
Disección, pinzas de ligadura



HP-90-250
29.5 cm

HP-90-251
29.5 cm

HP-90-252
30 cm

1/2

Overholt
HP-90-250 - HP-90-252
29.5 cm

1/2

Overholt-Mini
HP-90-253
15 cm

1/2

Overholt-Mini
HP-90-254
20 cm



1/2

Mini-Gemini
 HP-91-255 - HP-91-258
 18 cm

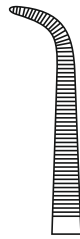

HP-91-255
 18 cm

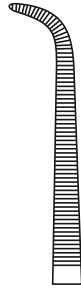

HP-91-256
 23 cm

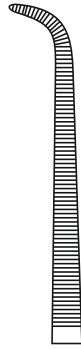

HP-91-257
 25 cm



HP-91-258
 28 cm



1/2

Gemini
 HP-91-259 - HP-91-265
 18 cm

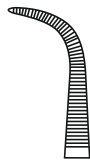

HP-91-259
 13 cm

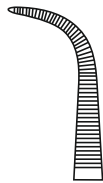

HP-91-260
 16 cm

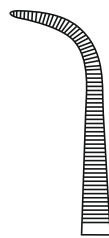

HP-91-261
 18 cm

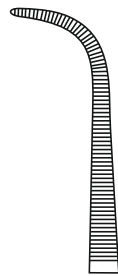

HP-91-262
 21 cm

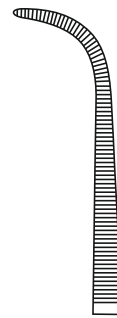

HP-91-263
 23 cm



HP-91-264
 25 cm

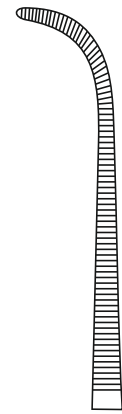

HP-91-265
 28 cm

Dissecting, Ligature Forceps
Präparierende Ligaturzange
Dissecando, Pinça de Ligadura
Disección, pinzas de ligadura



½

Mixer
HP-92-266 - HP-92-267

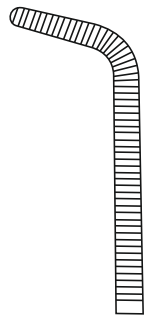

HP-92-266
16 cm

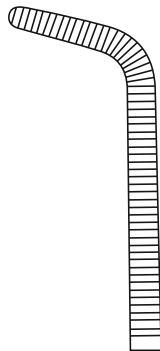

HP-92-267
17.5 cm

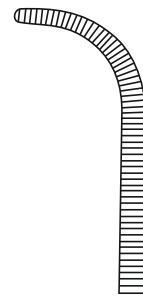

HP-92-268
15 cm

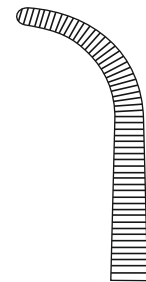

HP-92-269
18 cm



½

O'Shaughnessy
HP-92-268 - HP-92-273
23 cm



HP-92-270
18.5 cm



HP-92-271
20 cm

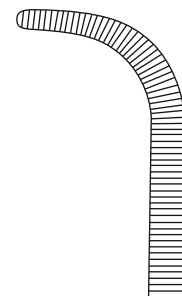

HP-92-272
23 cm

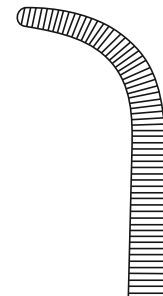

HP-92-273
24 cm

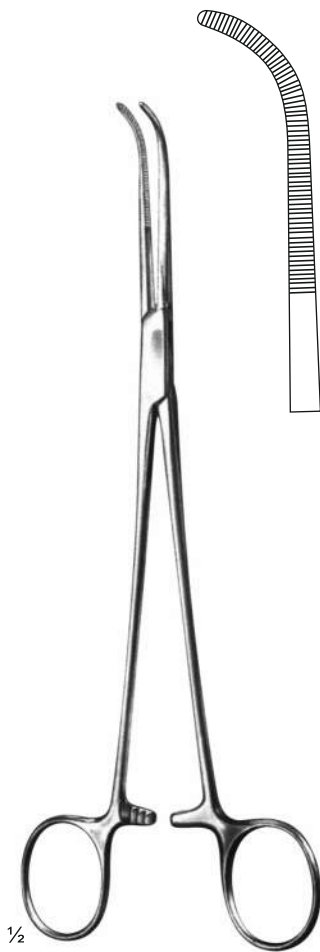

Mixer
HP-93-274
 22.5 cm



Mixer
HP-93-275
 23 cm



Zenker
HP-93-276 - HP-93-277
 28.5 cm



HP-93-276
 29.5 cm

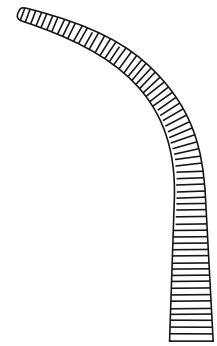

HP-93-277
 28.5 cm

Dissecting, Ligature Forceps
Präparierende Ligaturzange
Dissecando, Pinça de Ligadura
Disección, pinzas de ligadura



1/2

Mixer
HP-94-278 -HP-94-280
22.5 cm

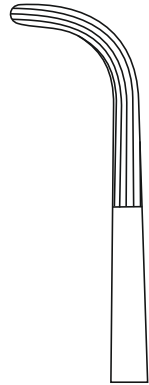

HP-94-278
22.5 cm

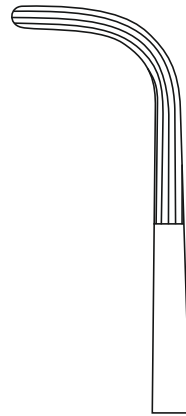

HP-94-279
26 cm

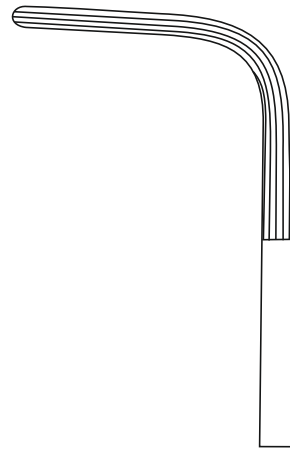

HP-94-280
28 cm

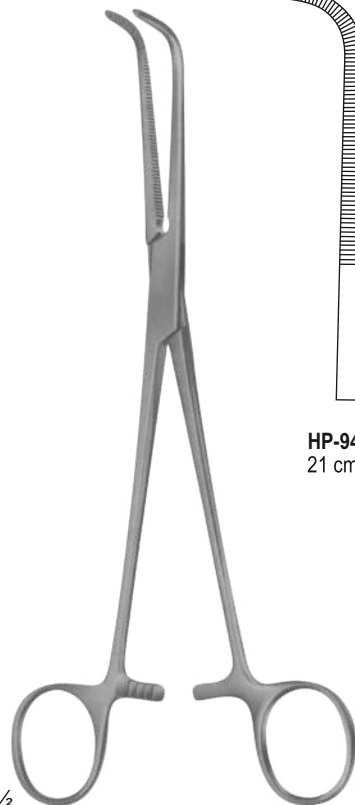

1/2

Wickström
HP-94-281 - HP-94-282
21 cm



HP-94-281
21 cm



HP-94-282
24.5 cm

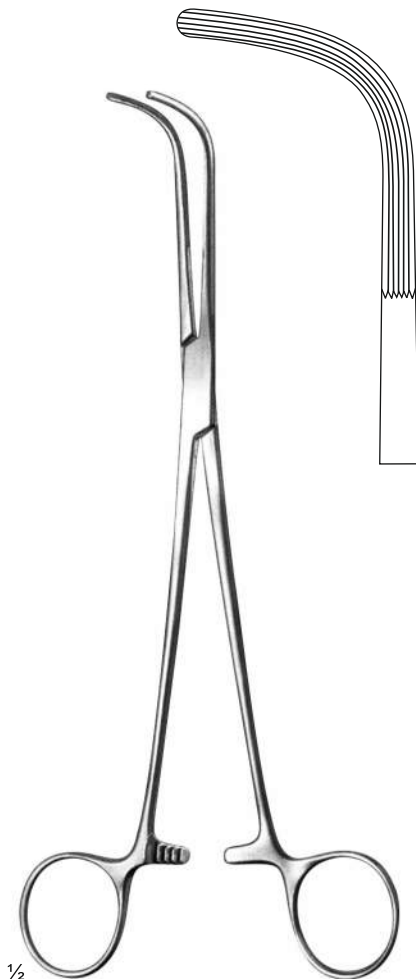

1/2

Mc Quigg-Mixer
HP-94-283
23.5 cm



1/2 Lower
HP-95-284
 18.5 cm
 Dissecting &
 ligature forceps



1/2 Lahey
HP-95-285 - HP-95-286
 19.5 cm
 Bile duct clamps

HP-95-285 19.5 cm
HP-95-286 22.5 cm



1/2 Desjardins
HP-95-287
 21 cm
 Bile duct clamps

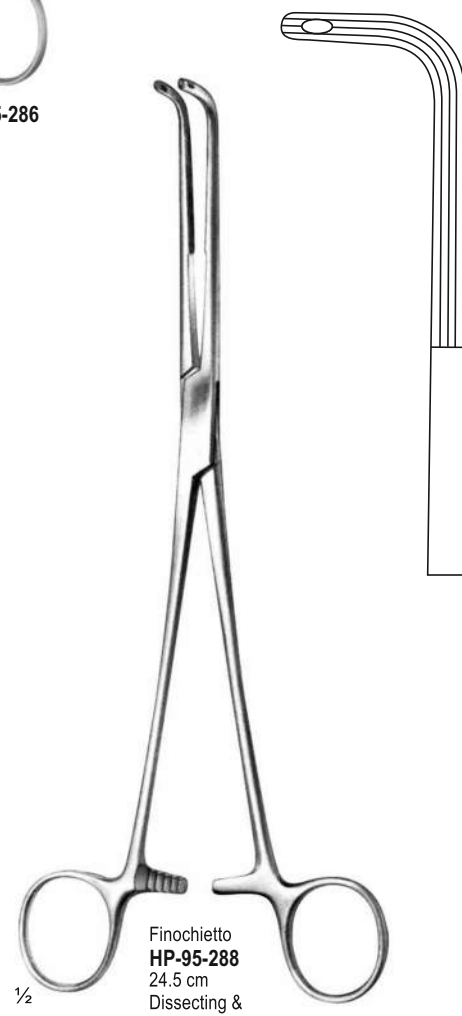

1/2 Finochietto
HP-95-288
 24.5 cm
 Dissecting &
 ligature forceps

Tangential Forceps, Kidney Pedicle Clamps
Tangential-Zange, Nieren-Pedikelklemme
Pinça tangencial, braçadeiras de pedículo do rim
Pinzas tangenciales, abrazaderas pediculares del riñón

ATRAUMA

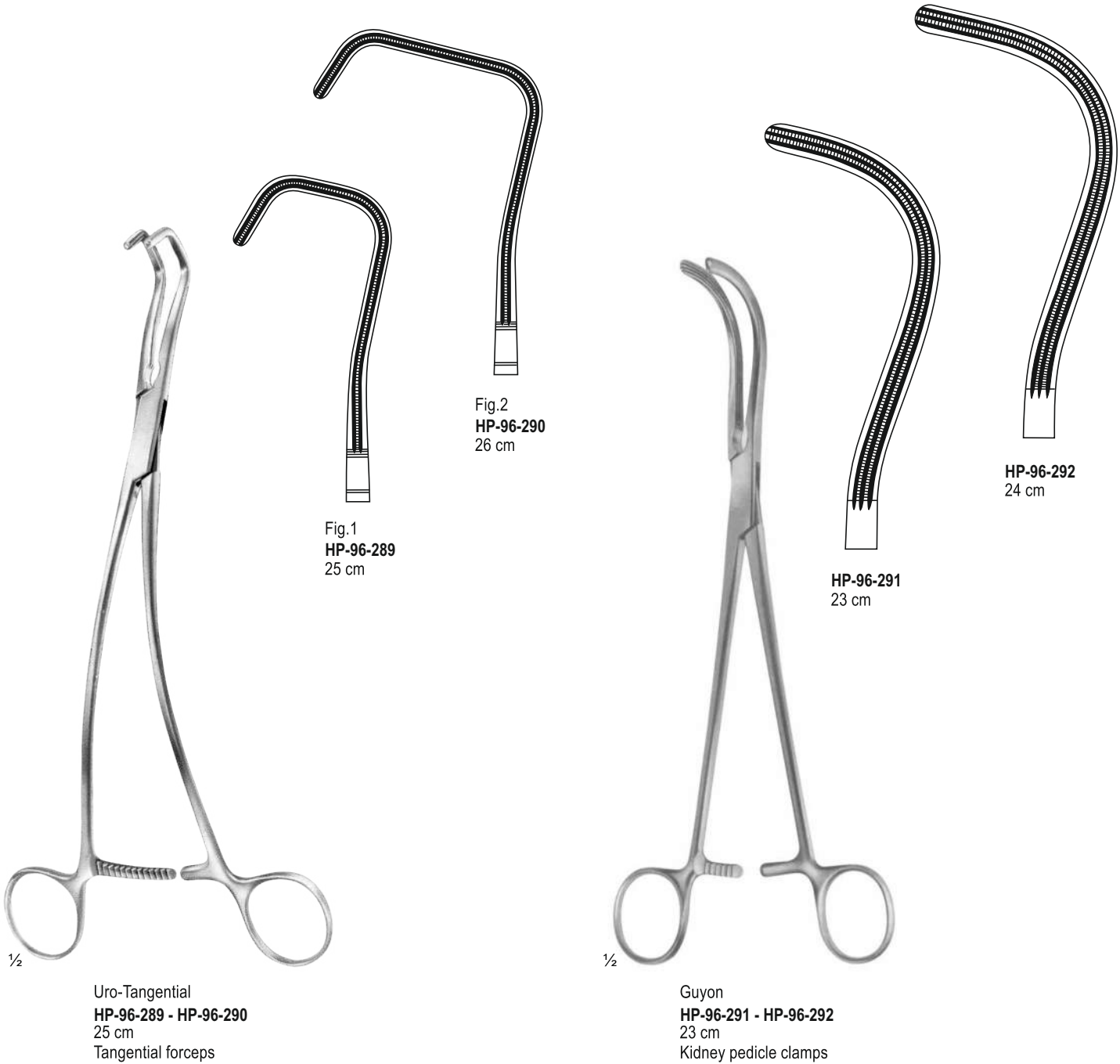

1/2

Uro-Tangential
HP-96-289 - HP-96-290
25 cm
Tangential forceps

1/2

Guyon
HP-96-291 - HP-96-292
23 cm
Kidney pedicle clamps

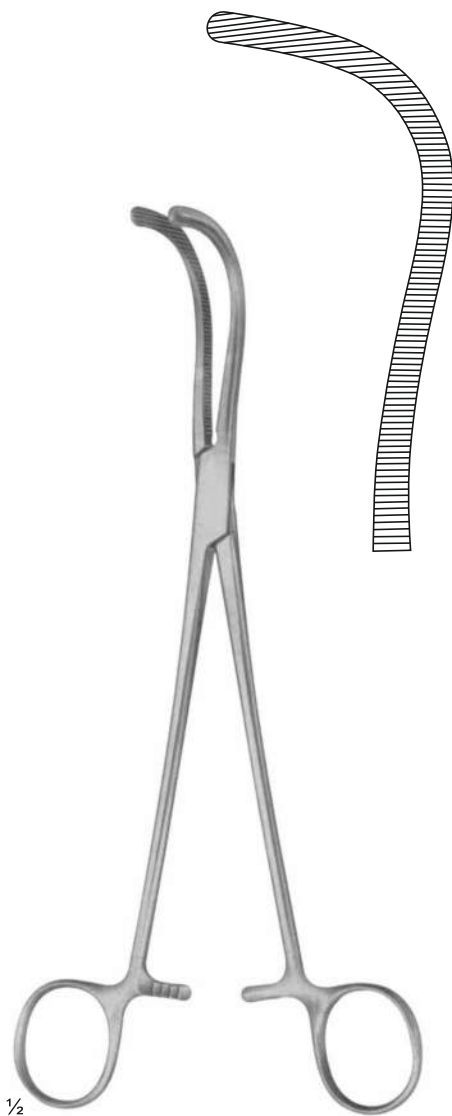

1/2

Guyon
HP-97-293
24 cm



1/2

Guyon
HP-97-294 - HP-97-296
24.5 cm



HP-97-294
19.5 cm



HP-97-295
21.5 cm

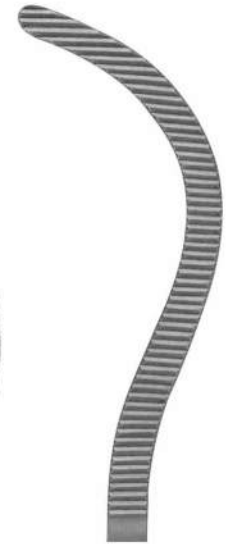

HP-97-296
24.5 cm

Dissecting, Ligature Forceps
Präparierende Ligaturzange
Dissecando, Pinça de Ligadura
Disección, pinzas de ligadura



Fig. 1
HP-98-298
19 cm



Fig. 1
HP-98-299
22.5 cm

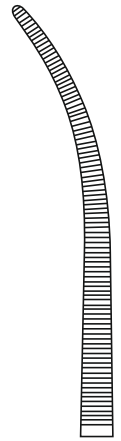

Fig. 1
HP-98-300
24 cm



Fig. 2
HP-98-301
19 cm



Fig. 2
HP-98-302
22 cm

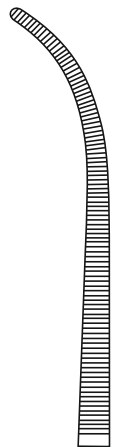

Fig. 2
HP-98-303
23.5 cm



Fig. 3
HP-98-304
18.5 cm



Fig. 3
HP-98-305
21.5 cm

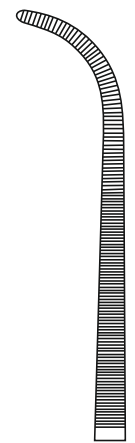

Fig. 3
HP-98-306
23.5 cm



1/2
 Wertheim-Cullen
HP-99-307
 21 cm
 Vaginal clamp



1/2
 Negus
HP-99-308 - HP-99-309
 20 cm
 Haemostatic forceps



Fig. 1
HP-99-308
 19.5 cm



Fig. 2
HP-99-309
 20 cm



1/2
 Lawrence
HP-99-310
 28 cm
 Dissecting & ligature forceps

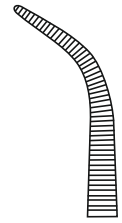

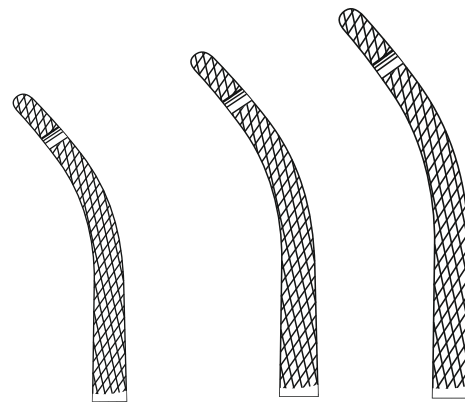

Fig. 1
HP-100-313
19.5 cm

Fig. 1
HP-100-314
21.5 cm

Fig. 1
HP-100-315
24 cm



HP-100-311
20.5 cm



HP-100-312
20 cm

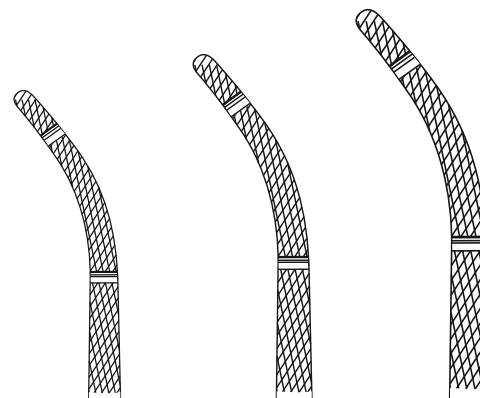

Fig. 2
HP-100-316
19.5 cm

Fig. 2
HP-100-317
21.5 cm

Fig. 2
HP-100-318
24 cm



½

Phaneuf
HP-100-311 - HP-100-312
20.5



½

Heaney
HP-100-313 - HP-100-318



Moynihan
HP-101-319
23 cm



Moynihan
HP-101-320
23.5 cm

Hysterectomy Forceps

Hysterektomie-Zange

Pinça de hysterectomia

Pinzas de hysterectomía



Wertheim
HP-102-321
26 cm



Wertheim
HP-102-322 - HP-102-323
22.5 cm

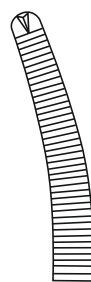

HP-102-322
Slightly curved

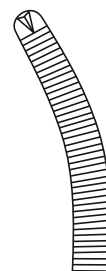

HP-102-323
Stronger curved



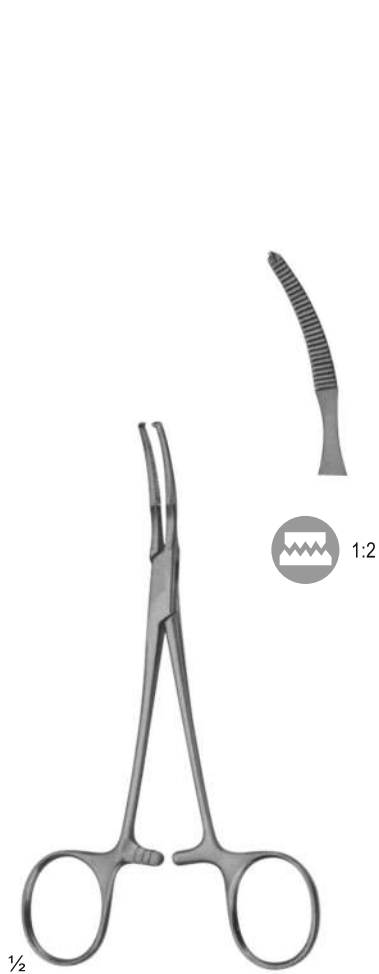

Mikulicz-Baby
HP-103-324
14.5 cm



Mikulicz
HP-103-325
18.5 cm



Mikulicz
HP-103-326
20 cm

Towel Clamps
Handtuchklammern
Braçadeiras de toalha
Abrazaderas de toalla

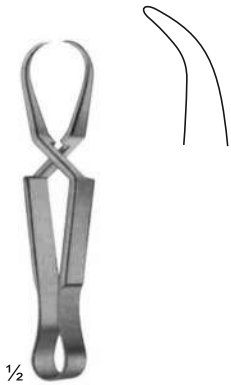

Schädel
HP-104-327
9 cm
Sharp

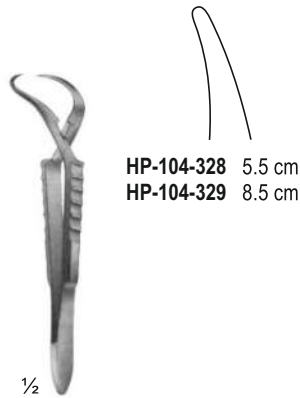

Jones
HP-104-328 - HP-104-329
8.5 cm
Sharp

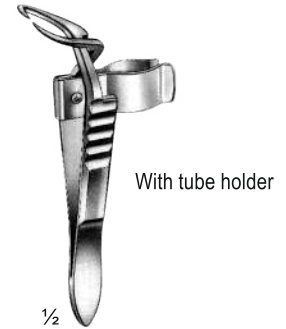

Jones-Martin
HP-104-330
8.5 cm
Sharp

With tube holder



Backhaus
HP-104-331
11 cm
With clip for tubing
up to 15 mm

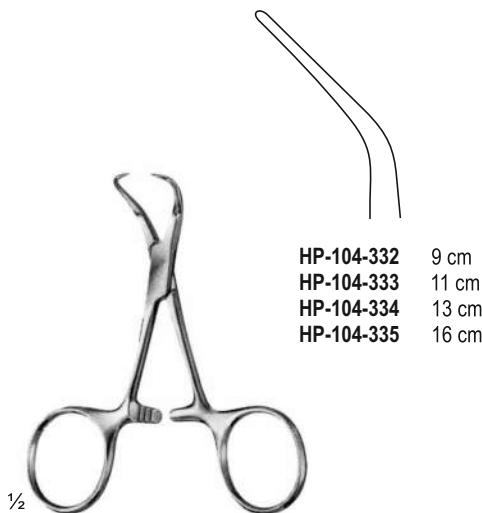

Backhaus
HP-104-332 - HP-104-335
9 cm
Sharp

HP-104-332 9 cm
HP-104-333 11 cm
HP-104-334 13 cm
HP-104-335 16 cm

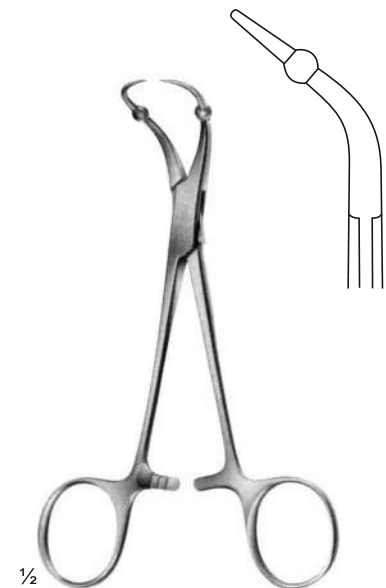

Roeder
HP-104-336
13.5 cm



Lorna
HP-105-337 - HP-105-338
13 cm
Fine serrated, wide jaw

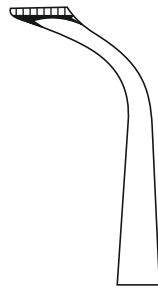

HP-105-337 10 cm
HP-105-338 13 cm



Ball + Socket
HP-105-339 - HP-105-342

HP-105-339 8 cm
HP-105-340 11 cm
HP-105-341 13 cm
HP-105-342 15 cm



Peers
HP-105-343 - HP-105-344
14 cm
For paper clothes

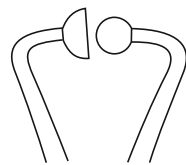

HP-105-343 11.5 cm
HP-105-344 14 cm

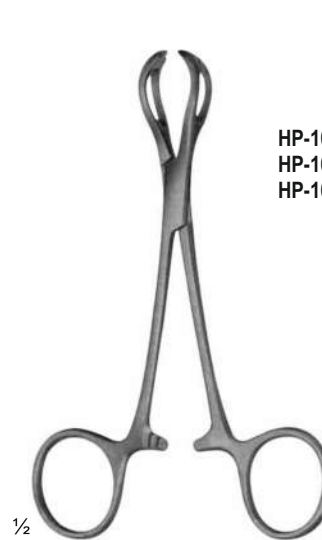

Lane
HP-105-345 - HP-105-347
13 cm
Towel clamp, organ and
tissue grasping forceps

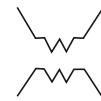

HP-105-345 13 cm
HP-105-346 15.5 cm
HP-105-347 19.5 cm

Tubing Clamps Roller Forceps
Schlauchschellen Roller Pinzetten
Braçadeiras de Tubulação Pinças de Rolo
Abrazaderas de tubo pinzas de rodillo



HP-106-348 15.5 cm
HP-106-349 19 cm
HP-106-350 20.5 cm

HP-106-348 - HP-106-350
15.5 cm

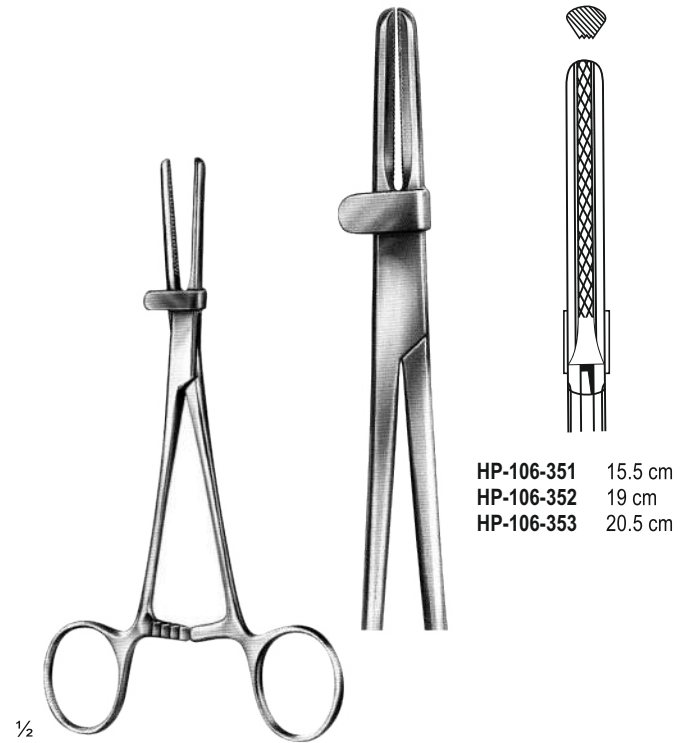

HP-106-351 15.5 cm
HP-106-352 19 cm
HP-106-353 20.5 cm

HP-106-351 - HP-106-353
15.5 cm
With safety guard



HP-106-354
16.5 cm
Smooth jaw

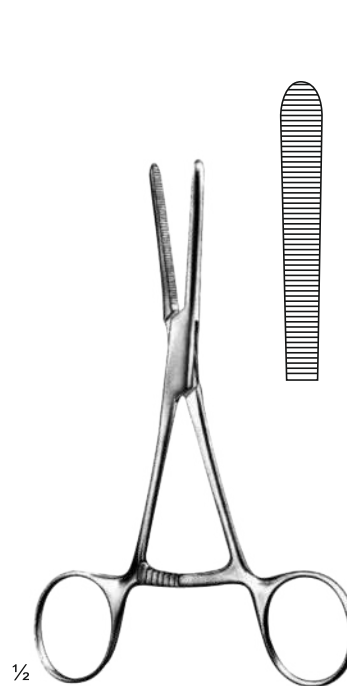

HP-106-355
14 cm
Extra long ratchet



Gunnar-Hey
HP-106-356
18 cm
Roller forceps



Cotton Swab Forceps

Wattestäbchen

Pinça de cotonete de algodão

Fórceps de algodón

Page 107-113

Dressing Forceps
Verbandzange
Pinça de Vestir
Vendaje de fórceps

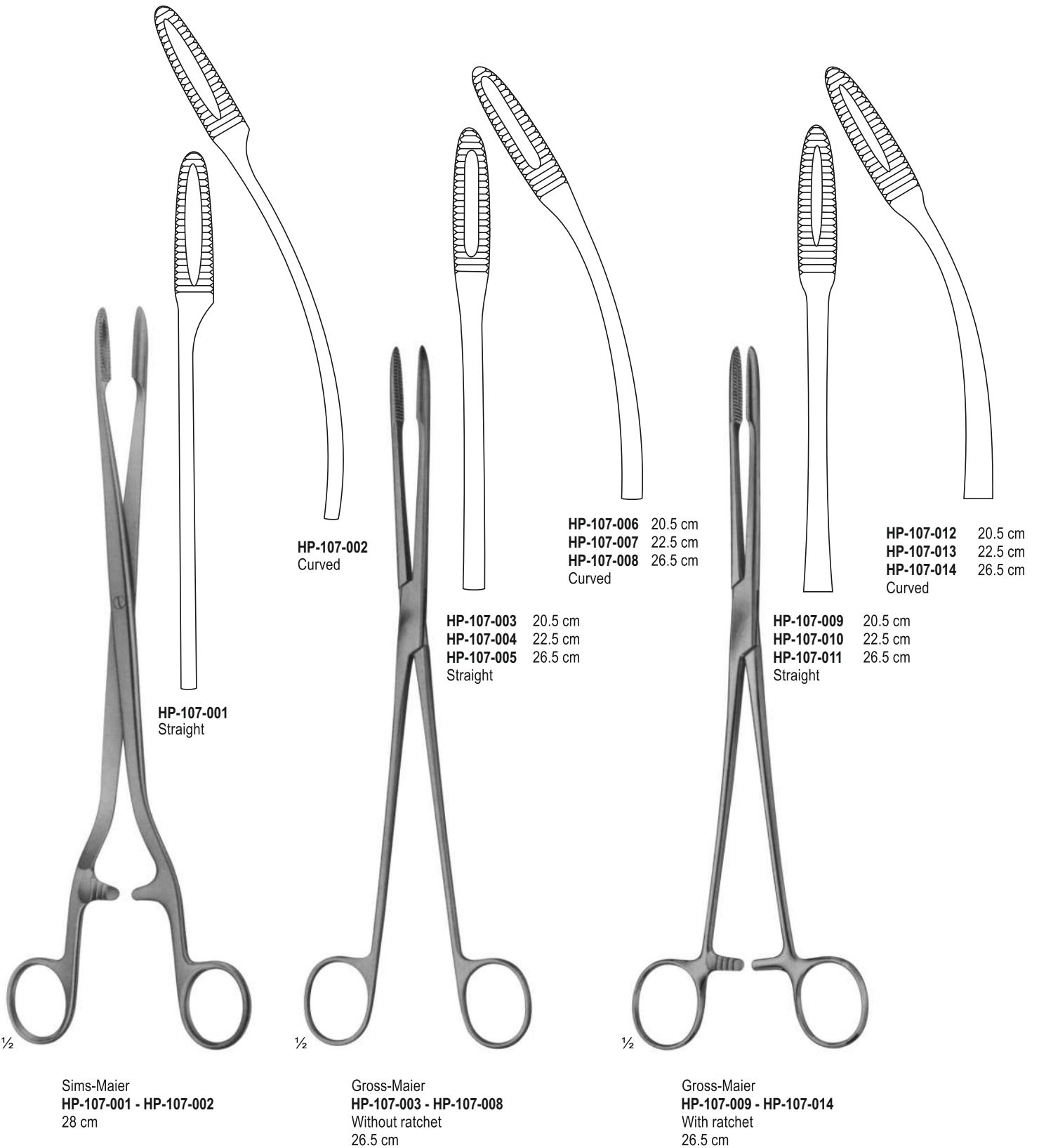

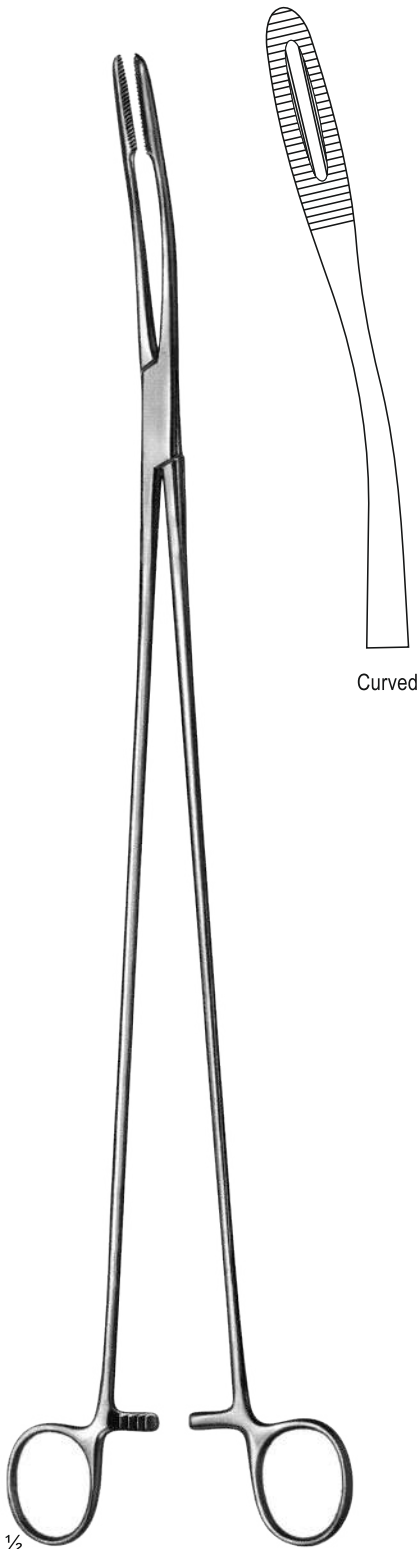

Curved

1/2

Tunneling Forceps
HP-108-015
39.5 cm

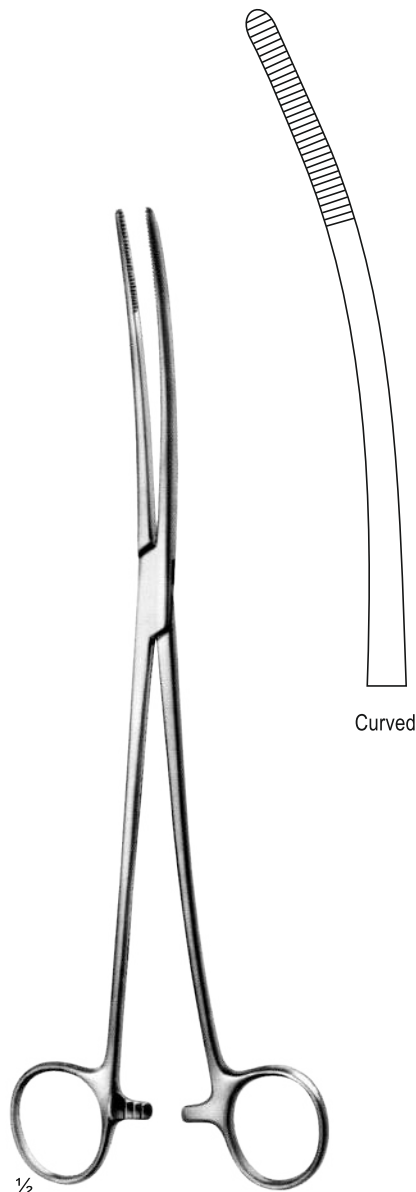

Curved

1/2

Bozemann
HP-108-016
26 cm
S-shape

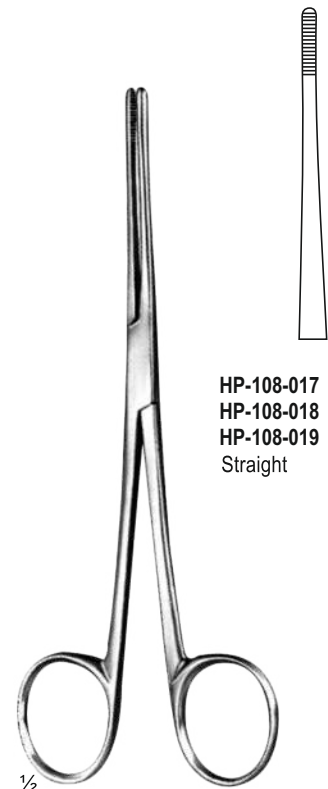

HP-108-017 13 cm
HP-108-018 16 cm
HP-108-019 18.5 cm
Straight

1/2

Lister
HP-108-017 - HP-108-019
18.5 cm
Sinus forceps

Spong Forceps
Schwammzange
Pinça Esponja
Fórceps de esponja

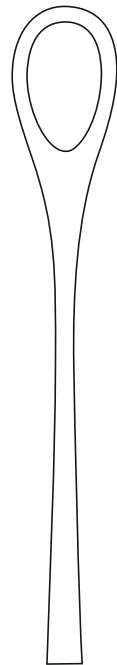

Smooth jaws
HP-109-020
25 cm
Straight

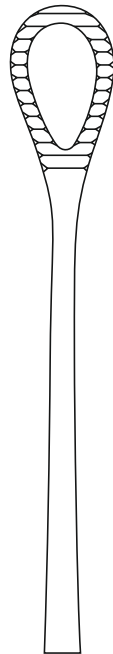

Serrated jaws
HP-109-021 18 cm
HP-109-022 20.5 cm
HP-109-023 25 cm
Straight



Smooth jaws
HP-109-024
25 cm
Curved

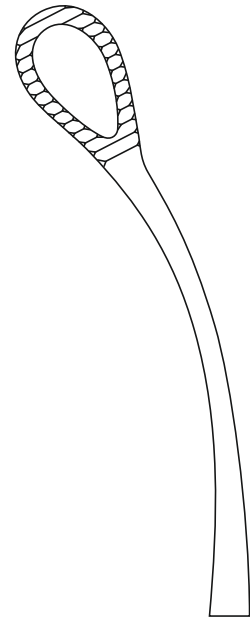

Serrated jaws
HP-109-025 18 cm
HP-109-026 20.5 cm
HP-109-027 25 cm
Curved



1/2

Foerster-Ballenger
CF-133-027 - HP-109-027
25 cm

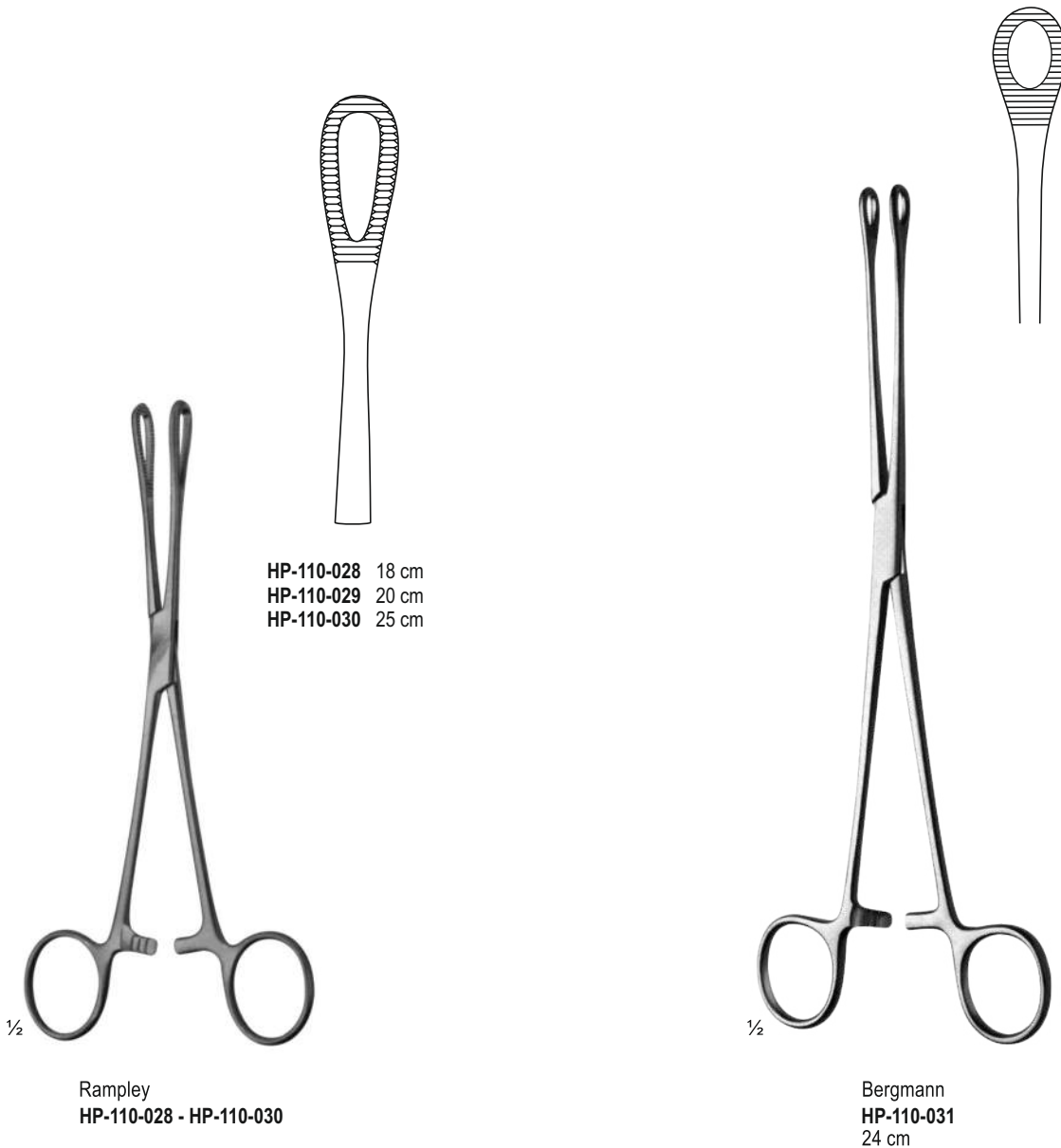

Spong Forceps
Schwammzange
Pinça Esponja
Fórceps de esponja

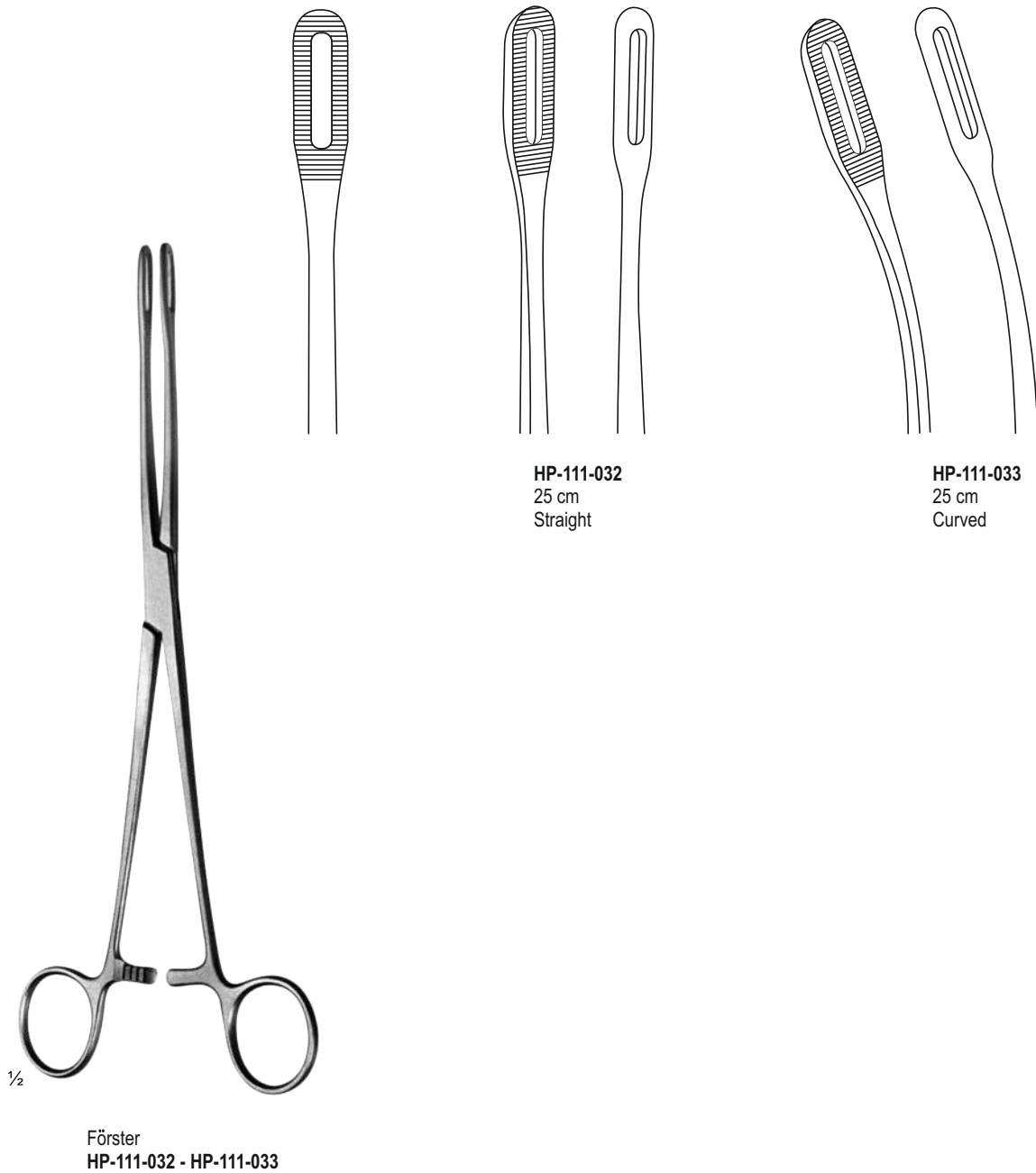



Pelkmann
HP-112-034
26 cm



Pelkmann
HP-112-035
26 cm

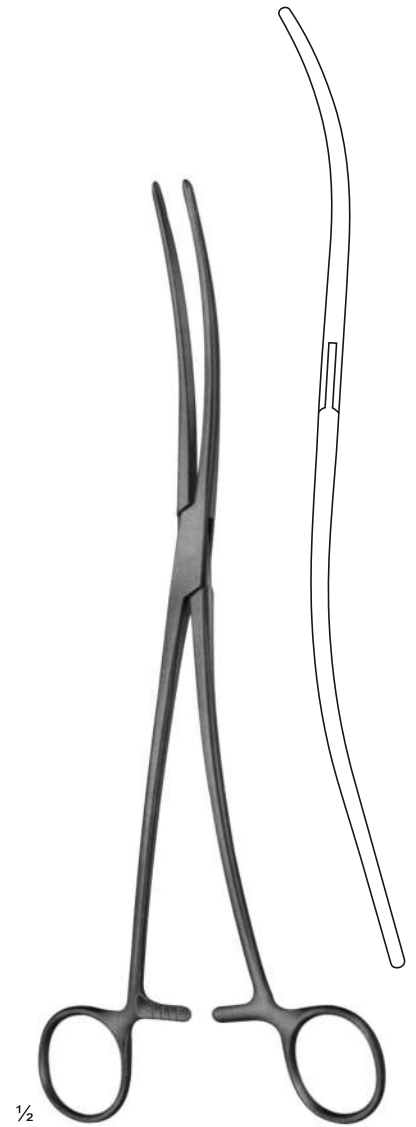

Bozemann
HP-112-036
25 cm

Uterine Dressing Forceps
Gebärmutterspangen
Pinça de Curativo Uterino
Fórceps de vendaje uterino

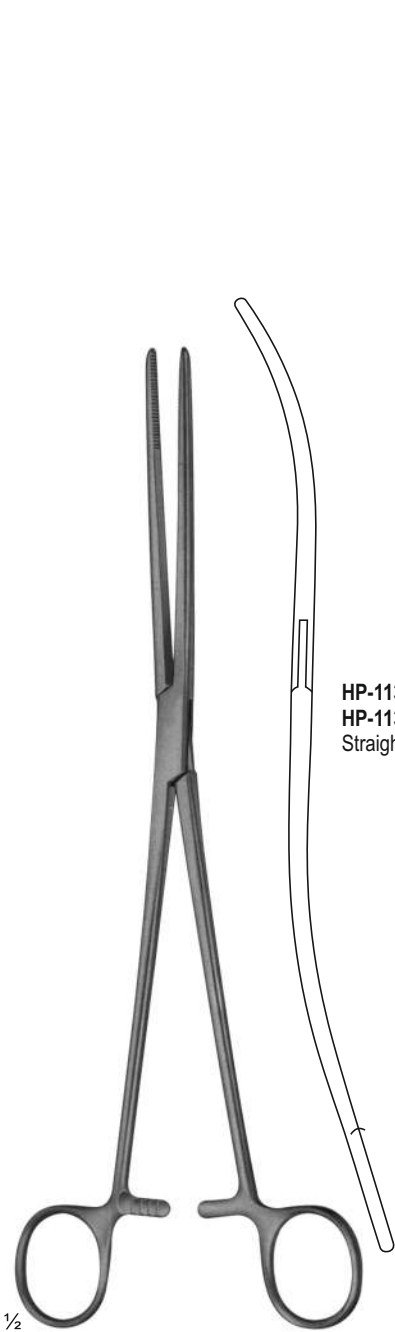

HP-113-037 25 cm
HP-113-038 26 cm
Straight

Bozemann
HP-113-037 - HP-113-038
26 cm

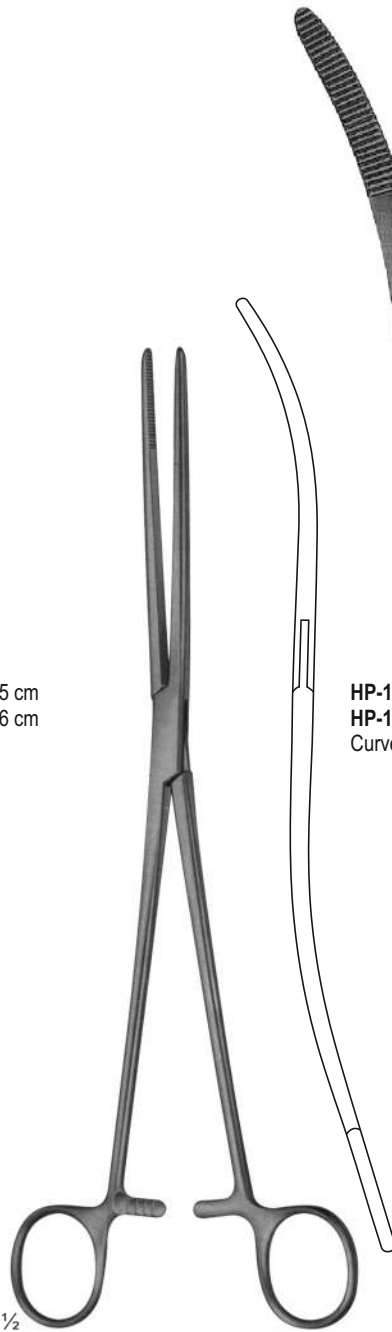

HP-113-039 25 cm
HP-113-040 26 cm
Curved

Bozemann
HP-113-039 - HP-113-040
26 cm

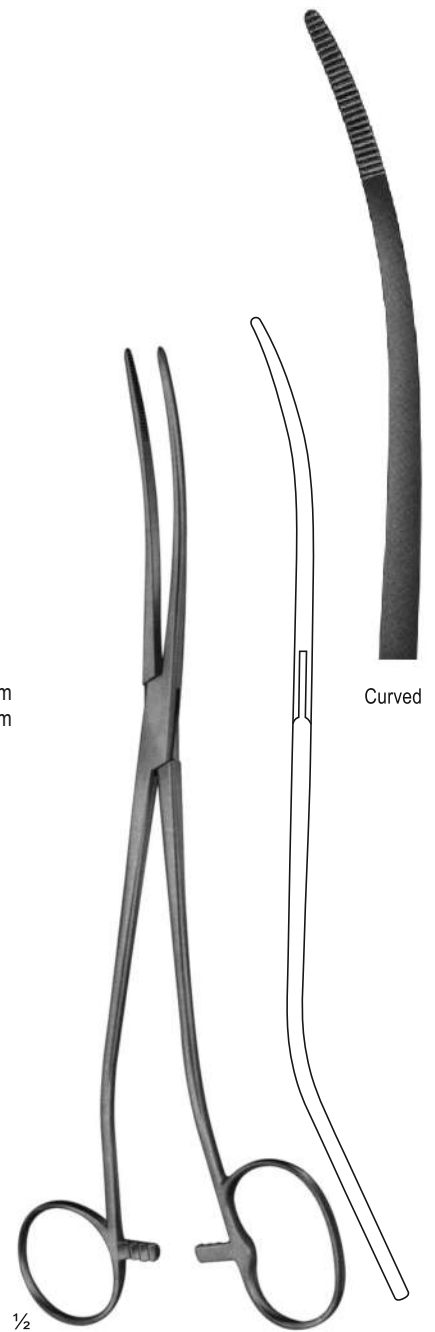

Curved

Bozemann-Douglas
HP-113-041
26 cm

06

Retractors

Wundhaken

Retratores

Retratores

Page 114-168

Fine Wound Retractors (Dura Hook, Skin Hooks)

Fein Wundhaken (Dura Hook, Skin Hooks)

Retradores de Ferida Fina (gancho Dura, ganchos de pele)

Retradores de heridas finas (gancho Dura, ganchos de piel)

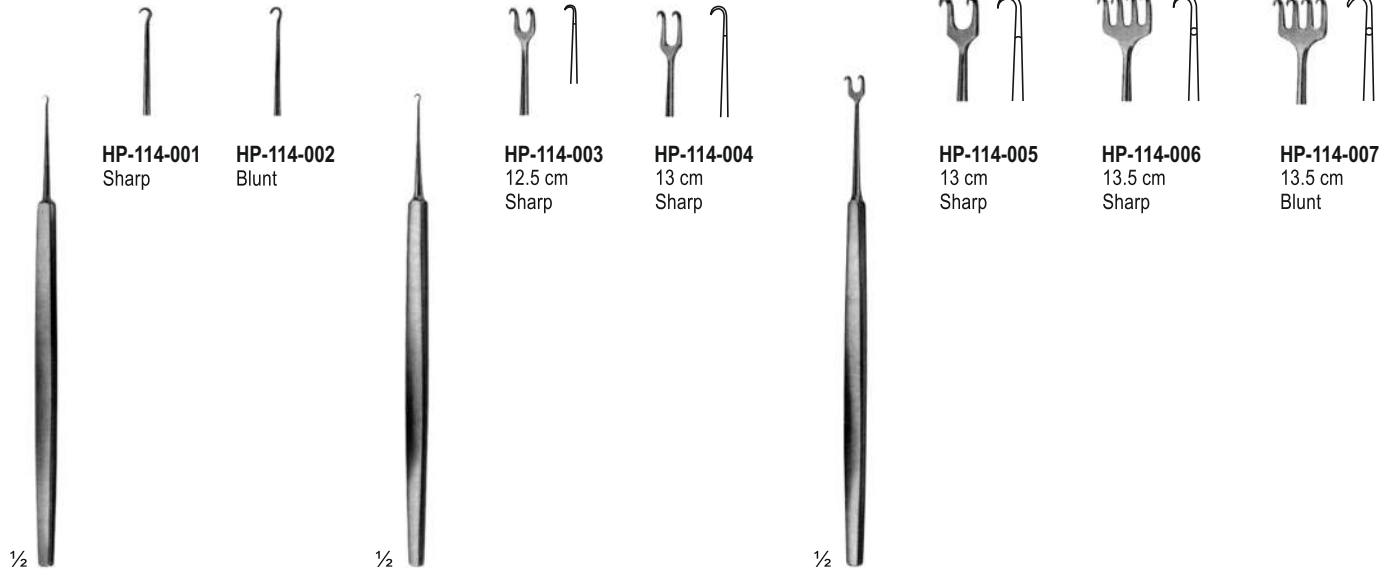

HP-114-001
Sharp

HP-114-002
Blunt

HP-114-003
12.5 cm
Sharp

HP-114-004
13 cm
Sharp

HP-114-005
13 cm
Sharp

HP-114-006
13.5 cm
Sharp

HP-114-007
13.5 cm
Blunt

Graefe
HP-114-001 - HP-114-002
12.5 cm
Micro hooklet

Guthrie
HP-114-003 - HP-114-004
12.5 cm
Skin hook

Rollet
HP-114-005 - HP-114-007

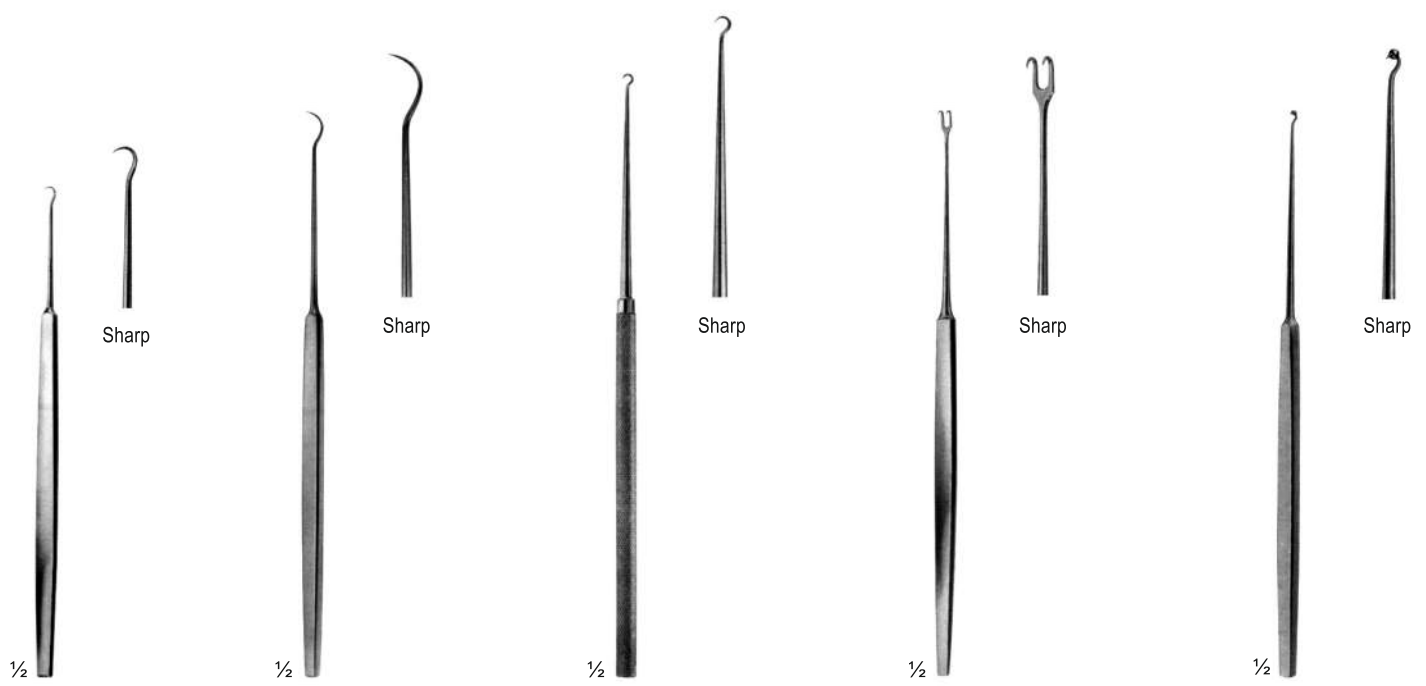

Sharp

Sharp

Sharp

Sharp

Sharp

Frazier
HP-114-008
13 cm
Dura hook

Tönnis
HP-114-009
15 cm
Dura hook

Kilner
HP-114-010
16 cm
Skin hooklet

Freer
HP-114-011
15 cm
Mucosa hooklet

Muller
HP-114-012
15 cm

Fine Wound Retractors (Dura Hook, Skin Hooks)
 Fein Wundhaken (Dura Hook, Skin Hooks)
 Retratores de Ferida Fina (gancho Dura, ganchos de pele)
 Retratores de heridas finas (gancho Dura, ganchos de piel)

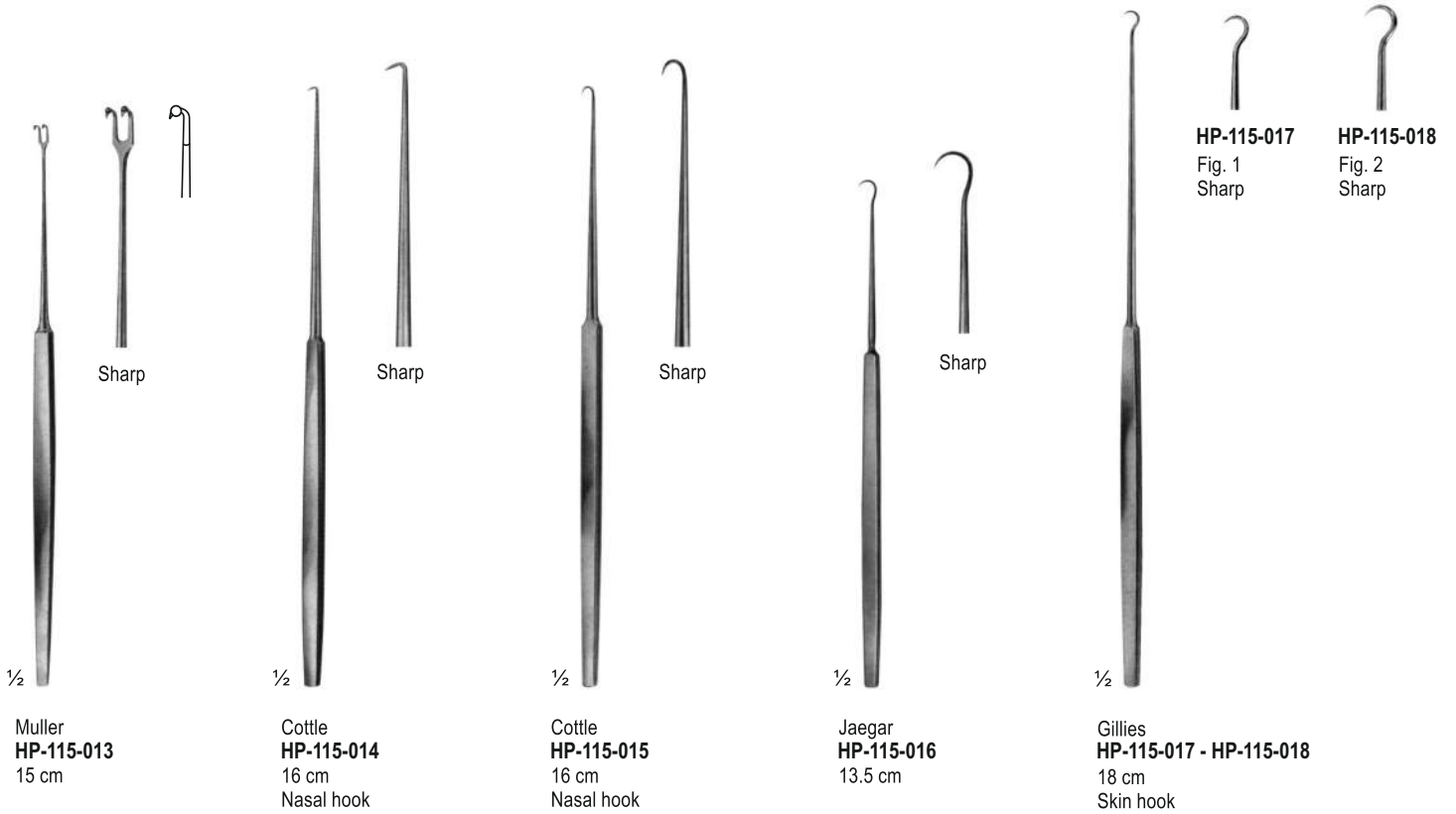

Muller
HP-115-013
 15 cm

Cottle
HP-115-014
 16 cm
 Nasal hook

Cottle
HP-115-015
 16 cm
 Nasal hook

Jaegar
HP-115-016
 13.5 cm

Gillies
HP-115-017 - HP-115-018
 18 cm
 Skin hook

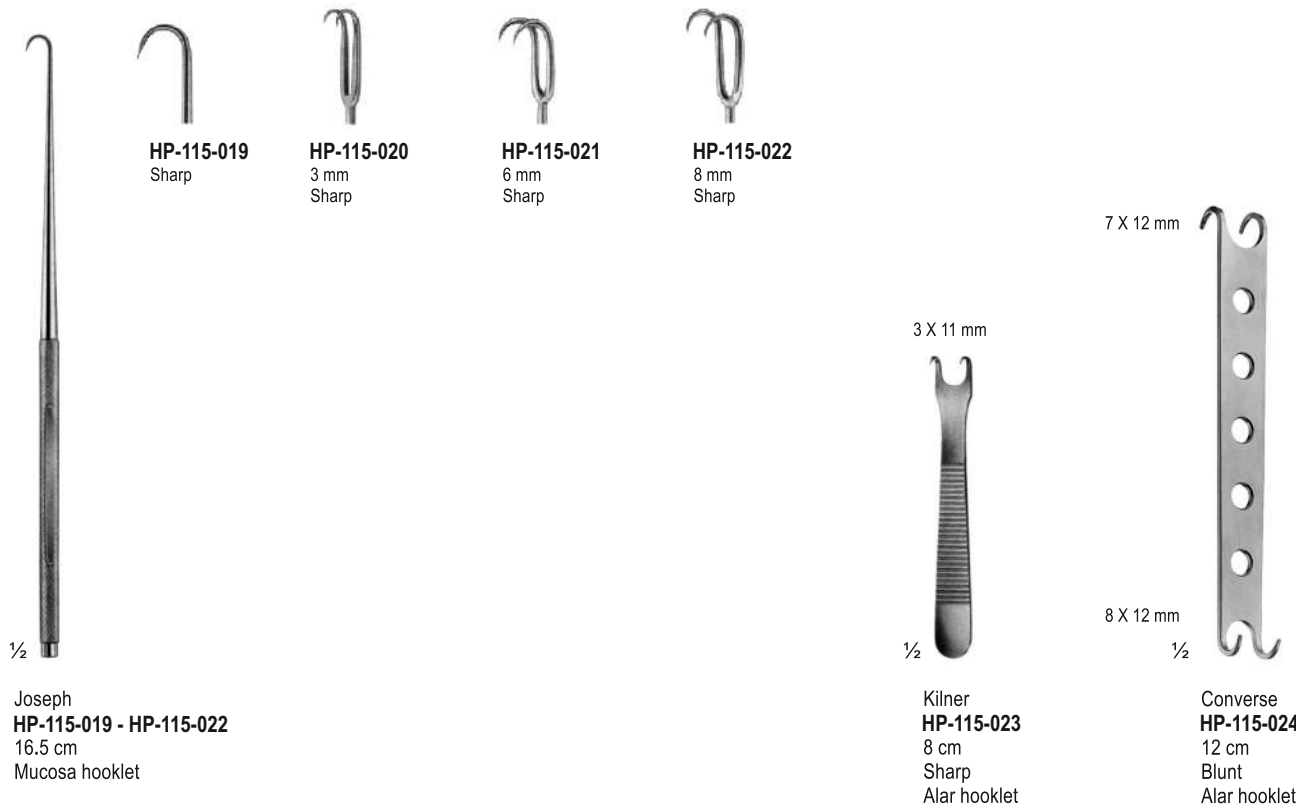

Joseph
HP-115-019 - HP-115-022
 16.5 cm
 Mucosa hooklet

Kilner
HP-115-023
 8 cm
 Sharp
 Alar hooklet

Converse
HP-115-024
 12 cm
 Blunt
 Alar hooklet

Wound - Trachea Retractors

Wunde - Trachea Retraktoren
Ferida - Retratores da Traquéia
Herida - Retratores de tráquea

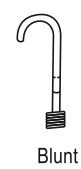
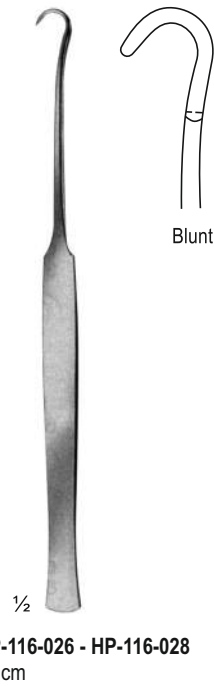



1/2



HP-117-035



HP-117-036



HP-117-037



HP-117-038



HP-117-039



HP-117-040



HP-117-041



HP-117-042

HP-117-035 - HP-117-042
 16.5 cm
 Large curve



1/2

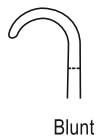

HP-117-043



HP-117-044



HP-117-045



HP-117-046



HP-117-047



HP-117-048



HP-117-049



HP-117-050

HP-117-043 - HP-117-050
 16.5 cm
 Large curve

Retractors Fistula Hooks

Retraktoren Fistelhaken
Ganchos de fistula retratores
Retradores Fistula Hooks

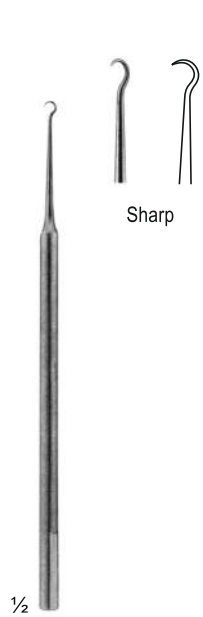

Sharp

½

Mannerfelt Modif.
HP-118-051
13.5 cm

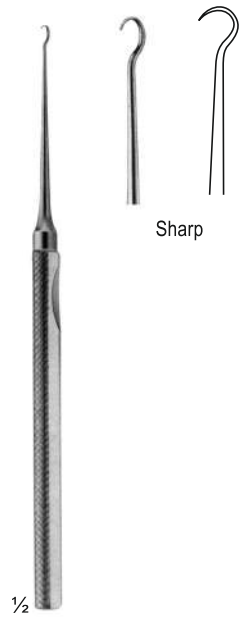

Sharp

½

Mannerfelt Modif.
HP-118-052
15.5 cm

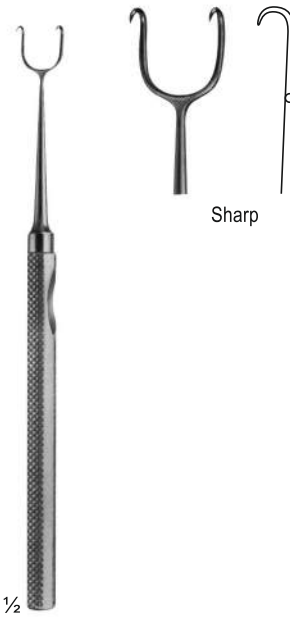

Sharp

½

Mannerfelt Modif.
HP-118-053
15.5 cm

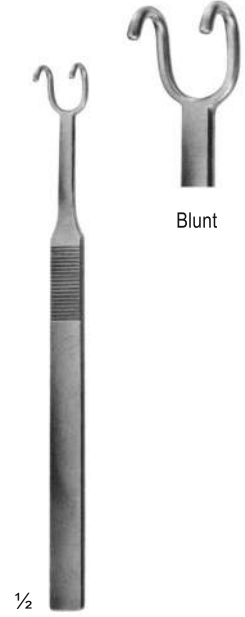

Blunt

½

Fomon
HP-118-054
14.5 cm
Alar hooklet



Sharp

½

Emmet
HP-118-055
22 cm
Fistula hook



Sharp

½

Simon
HP-118-056
22 cm
Fistula hook

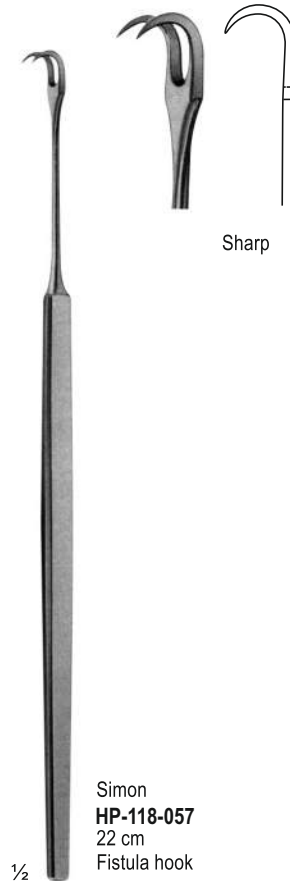

Sharp

½

Simon
HP-118-057
22 cm
Fistula hook



½

Lange
HP-118-058
23 cm
Fistula hook



HP-119-059



HP-119-060

HP-119-059 - HP-119-060
16 cm
Sharp



12 x 6 mm

HP-119-061

Tendon Hook
HP-119-061 - HP-119-062
17.5 cm
Blunt



12 x 11 mm

HP-119-062



Sharp



HP-119-063



HP-119-064



1/2

Mannerfelt Modif.
HP-119-063 - HP-119-064
15.5 cm
Small curve



Blunt



HP-119-065



HP-119-066



1/2

Mannerfelt Modif.
HP-119-065 - HP-119-067
15.5 cm
Large curve



HP-119-067

Retractors, Hooklets

Retraktoren, Haken
Retratores, Hooklets
Retradores, Hooklets

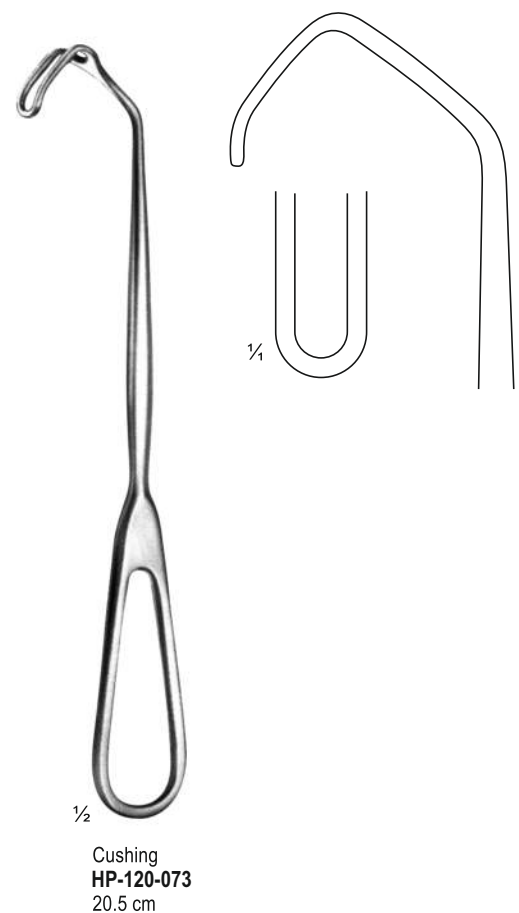
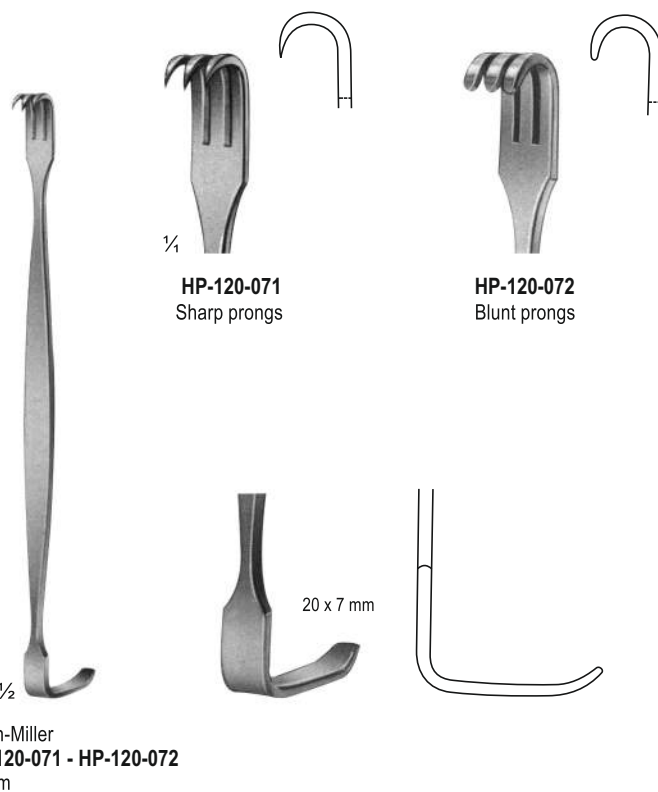
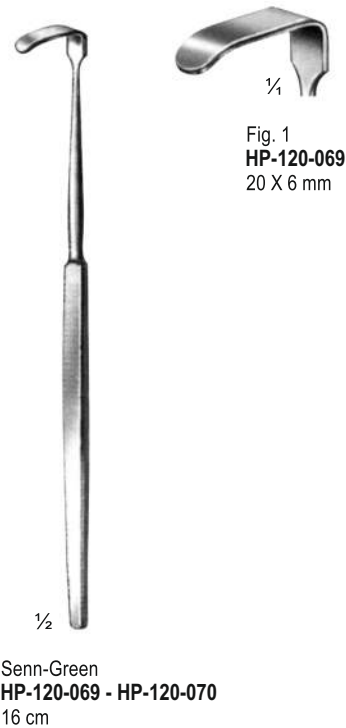
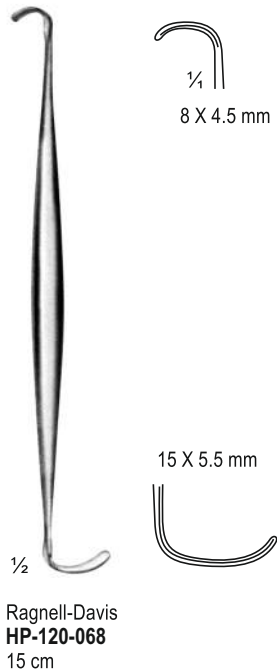

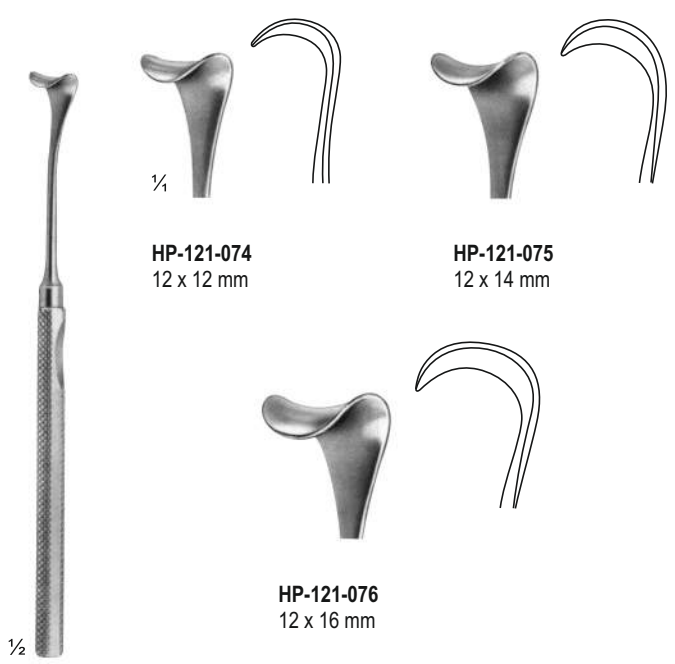

HP-121-074
12 x 12 mm

HP-121-075
12 x 14 mm

HP-121-076
12 x 16 mm

1/2

Mannerfelt Modif.
HP-121-074 - HP-121-076
15.5 cm
Saddle hooks

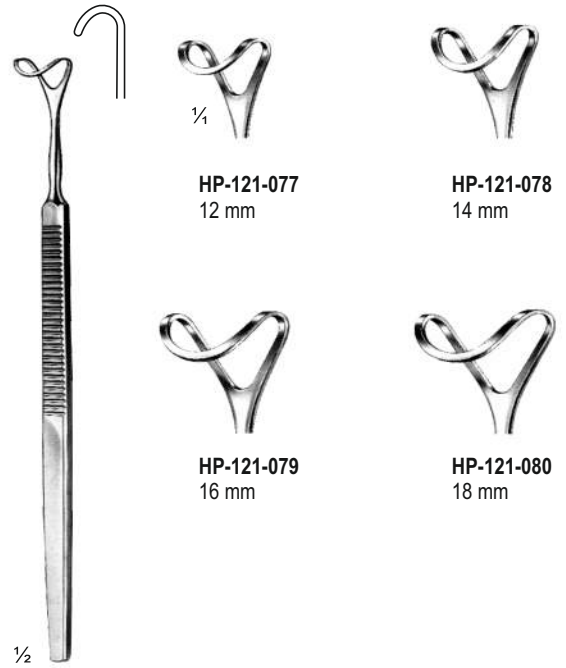

HP-121-077
12 mm

HP-121-078
14 mm

HP-121-079
16 mm

HP-121-080
18 mm

1/2

HP-121-077 - HP-121-080
16 cm

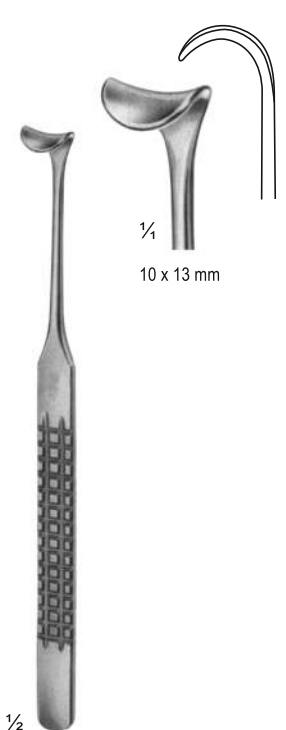

HP-121-081
10 x 13 mm

1/2

HP-121-081
16 cm

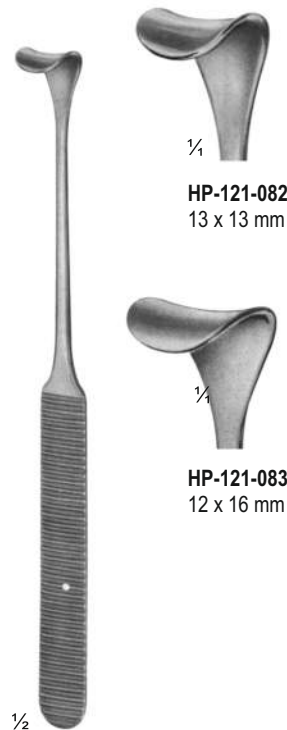

HP-121-082
13 x 13 mm

HP-121-083
12 x 16 mm

1/2

König
HP-121-082 - HP-121-083
18 cm



HP-121-084
10 x 10 mm

1/2

Cushing-Kocher
HP-121-084
17.5 cm

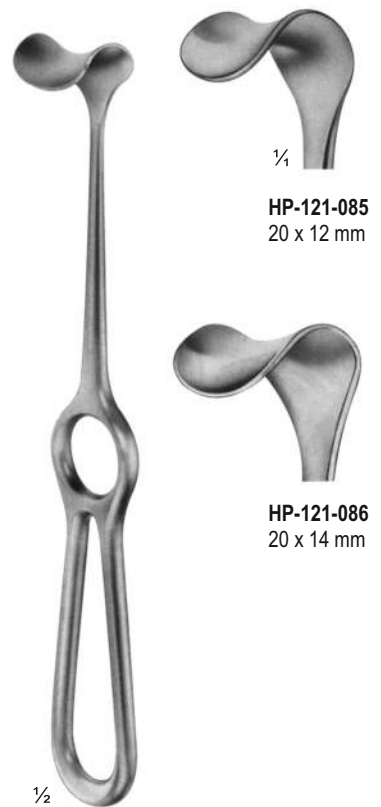

HP-121-085
20 x 12 mm

HP-121-086
20 x 14 mm

1/2

Kocher
HP-121-087 - HP-121-086
20.5cm

Retractors, Saddle Hooks

Retraktoren, Sattelhaken
Retratores, ganchos de sela
Retradores, ganchos de la silla de montar



1/2
Masing
HP-122-087
14 cm



1/4
6 x 12 mm

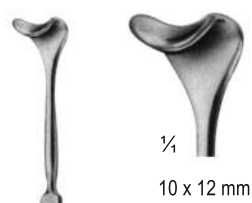

1/2
Cottle
HP-122-088
14 cm
Saddle



1/4
10 x 12 mm

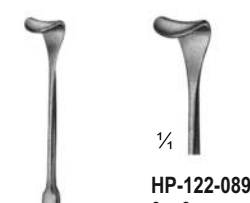

1/2
Desmarres
HP-122-089 - HP-122-093
14 cm
Saddle hook



1/4
HP-122-089
9 x 9 mm



HP-122-090
9 x 12 mm



HP-122-091
9 x 14 mm



HP-122-092
12 x 16 mm



HP-122-093
13 x 18 mm



1/2
Cushing
HP-122-094 - HP-122-095
20.5 cm
Saddle hook



1/4
HP-122-094
10 x 13 mm



HP-122-095
14 x 18 mm



20 x 15 mm
20 x 19 mm
1/2
HP-122-096
20.5 cm



1/2
Cushing
HP-122-097 - HP-122-099
25 cm
Saddle hook



1/4
HP-122-097
11 x 14 mm



HP-122-098
13 x 18 mm



HP-122-099
15 x 22 mm



¼

HP-123-100
8 mm



HP-123-101
10 mm



¼

HP-123-106
8 mm



HP-123-107
10 mm



HP-123-102
12 mm



HP-123-103
14 mm



HP-123-108
12 mm



HP-123-109
14 mm



½

Cushing
HP-123-100 - HP-123-105
10.5 cm



HP-123-104
16 mm



HP-123-105
18 mm



HP-123-110
16 mm



HP-123-111
18 mm



½

Cushing
HP-123-106 - HP-123-111
24 cm

Saddle Hooks, Vein Hooks
Sattelhaken, Venen Haken
Ganchos de sela, ganchos de veia
Ganchos de la silla de montar, ganchos de la vena



1/2

Gil-Vernet
HP-124-112 - HP-124-119
24 cm
Saddle hook
malleable shaft



1/4

HP-124-112
4 mm



HP-124-113
6 mm



HP-124-114
8 mm



HP-124-115
11 mm



HP-124-116
15 mm



HP-124-117
17 mm



HP-124-118
20 mm



HP-124-119
23 mm



1/2

Brom
HP-124-120 - HP-124-121
19 cm
Vein hook



1/4

HP-124-120
Narrow



HP-124-121
Wide



1/2

Strandell-Stille
HP-124-122 - HP-124-123
19 cm
Hooklet

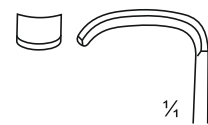

1/4

Fig. 1
HP-124-122
Smooth blade end

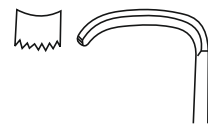

Fig. 2
HP-124-123
Toothed blade end



1/2

Klapp
HP-125-124 - HP-125-126
18 cm
blunt



1/4

HP-125-124
13 x 6 mm



HP-125-125
12 x 11 mm



HP-125-126
15 x 12 mm



1/2

HP-125-127 - HP-125-128
16.5 cm

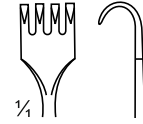

1/4

HP-125-127
sharp

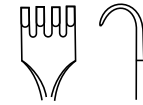

HP-125-128
blunt



1/2

Volkman
HP-125-129 - HP-125-138
21.5 cm

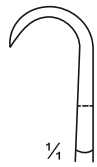

1/4

HP-125-129
Sharp



HP-125-130
9 x 8 mm



HP-125-131
9 x 13 mm



HP-125-132
9 x 19 mm



HP-125-133
9 x 29 mm

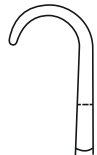

HP-125-134
Blunt



HP-125-135
8.5 x 8 mm



HP-125-136
8.5 x 13 mm



HP-125-137
8.5 x 19 mm



HP-125-138
8.5 x 29 mm

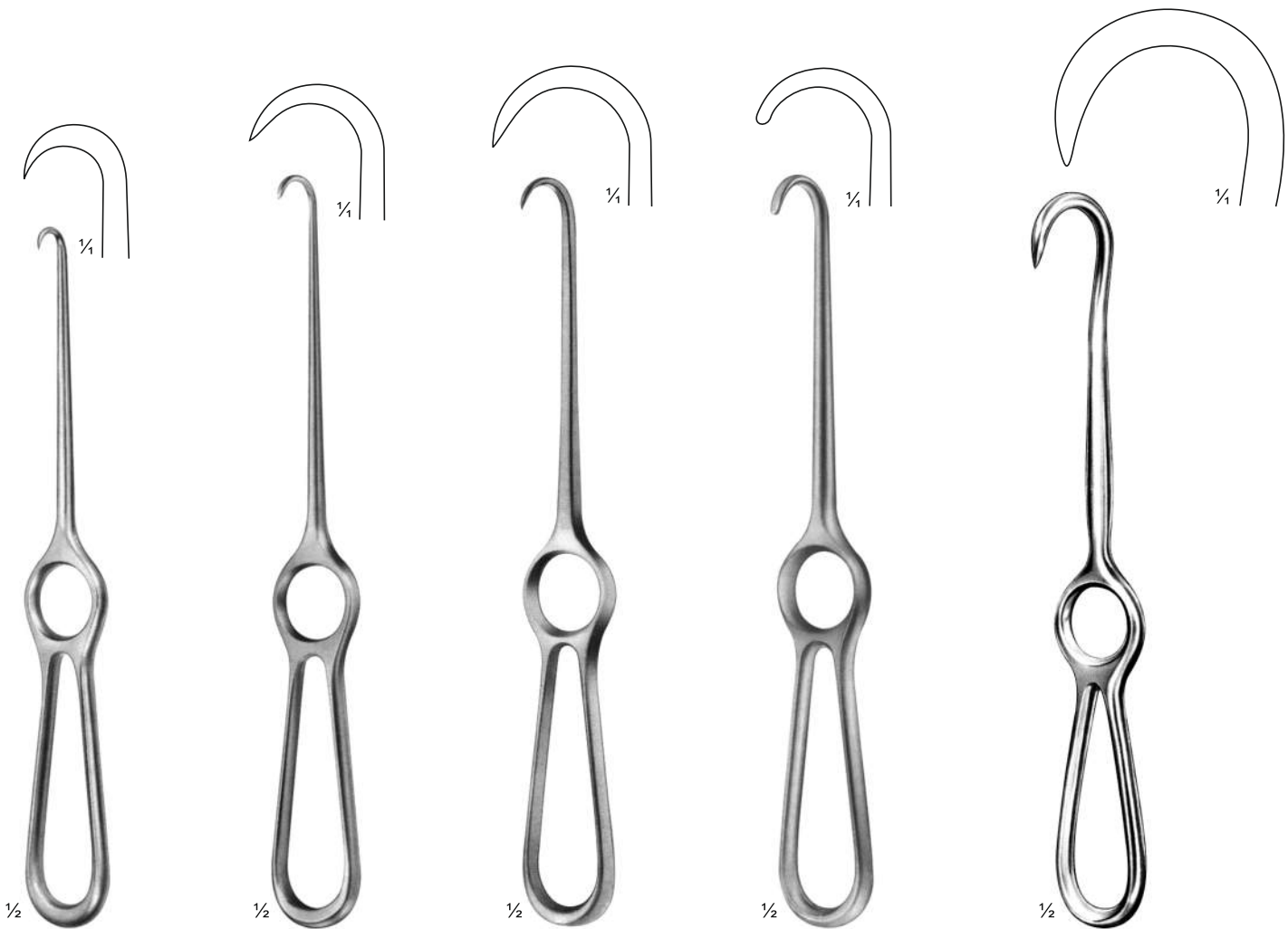

Kocher
HP-126-139
20.5 cm
Sharp

Kocher
HP-126-140
22 cm
Sharp

Volkmann
HP-126-141
22 cm
Sharp

Volkmann
HP-126-142
22 cm
Blunt

HP-126-143
21.5 cm
Sharp



1/2

Volkmann
HP-127-144 - HP-127-157
22 cm

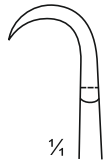

1/4

Sharp



HP-127-144



HP-127-145



HP-127-146



HP-127-147



HP-127-148

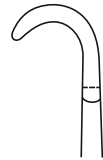

Blunt



HP-127-149



HP-127-150



HP-127-151



HP-127-152



HP-127-153

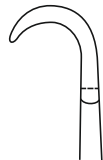

Semi-Sharp



HP-127-154



HP-127-155



HP-127-156



HP-127-157



1/2

Kocher
HP-127-158 - HP-127-171
22 cm

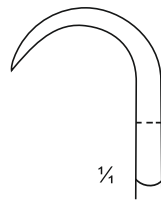

1/4

Sharp



HP-127-158



HP-127-159



HP-127-160



HP-127-161



HP-127-162

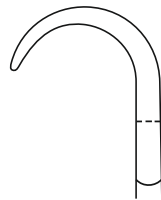

Blunt



HP-127-163



HP-127-164



HP-127-165



HP-127-166



HP-127-167

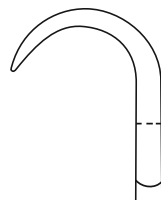

Semi-Sharp



HP-127-168



HP-127-169



HP-127-170



HP-127-171

Retractors
Wundhaken
Retratores
Retradores

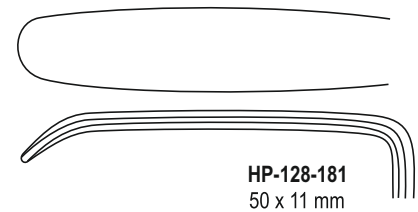
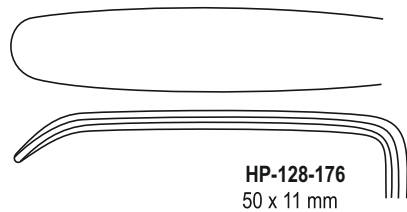
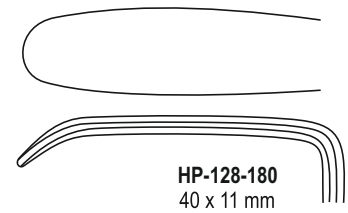
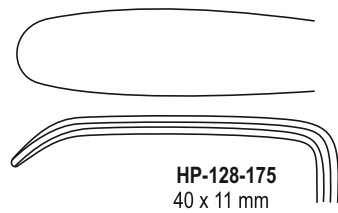
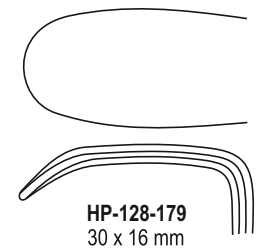
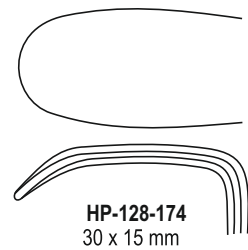
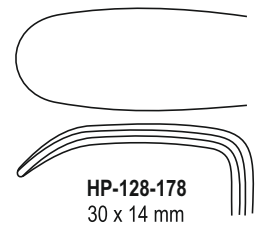
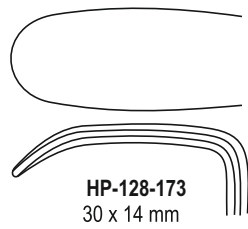
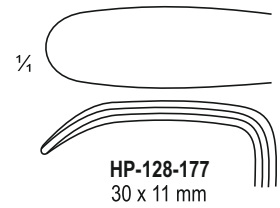
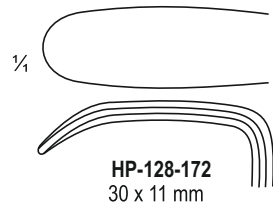

Langenbeck
HP-128-172 - HP-128-176
22 cm



Langenbeck
HP-128-177 - HP-128-181
22 cm

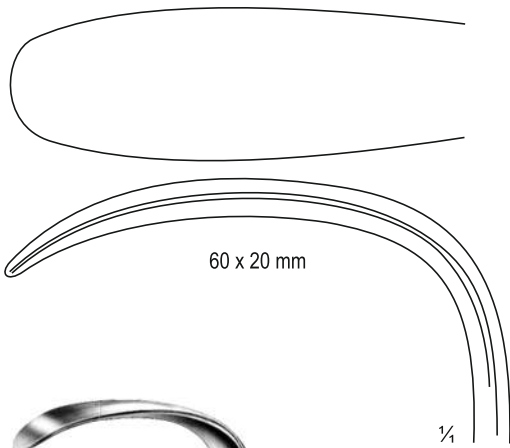

Langenbeck
HP-129-182
21 cm

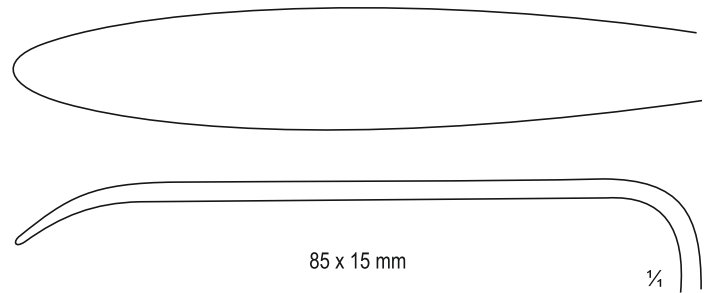

Langenbeck
HP-129-183
22.5 cm

Retractors
 Wundhaken
 Retratores
 Retratores

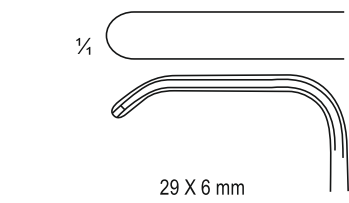

1/2

Lahey
HP-130-184
 19.5 cm

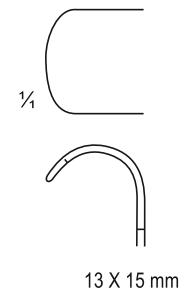

1/2

Little
HP-130-185
 20.5 cm



Kocher-Langenbeck
HP-131-186 - HP-131-194
21.5 cm

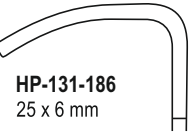

HP-131-186
25 x 6 mm

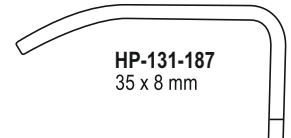

HP-131-187
35 x 8 mm

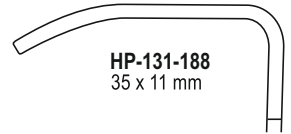

HP-131-188
35 x 11 mm

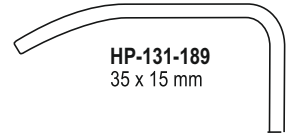

HP-131-189
35 x 15 mm

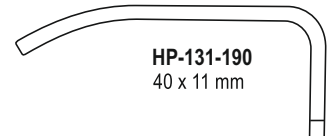

HP-131-190
40 x 11 mm

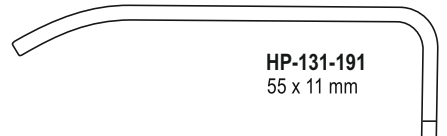

HP-131-191
55 x 11 mm

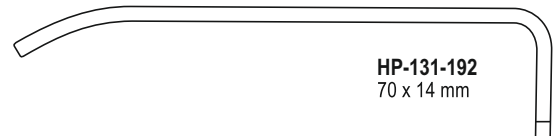

HP-131-192
70 x 14 mm

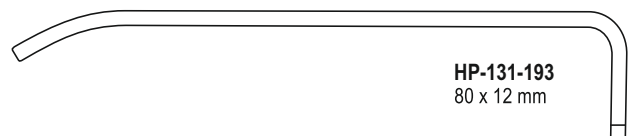

HP-131-193
80 x 12 mm

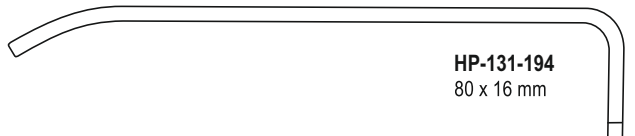

HP-131-194
80 x 16 mm



Kocher-Langenbeck
HP-132-195 - HP-132-202
21.5 cm



HP-132-195
25 x 10 mm

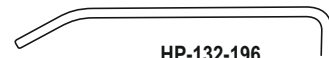

HP-132-196
40 x 13 mm



HP-132-197
60 x 13 mm

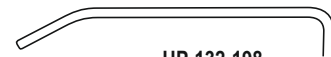

HP-132-198
40 x 18 mm



HP-132-199
60 x 18 mm



HP-132-200
85 x 18 mm



HP-132-201
60 x 25 mm



HP-132-202
85 x 25 mm



Fritsch
HP-133-203 - HP-133-208
25.5 cm

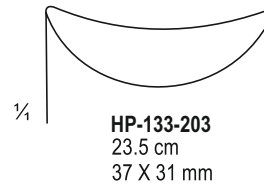

HP-133-203
23.5 cm
37 X 31 mm

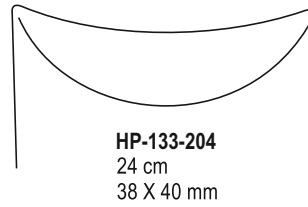

HP-133-204
24 cm
38 X 40 mm

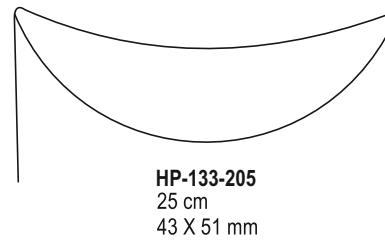

HP-133-205
25 cm
43 X 51 mm

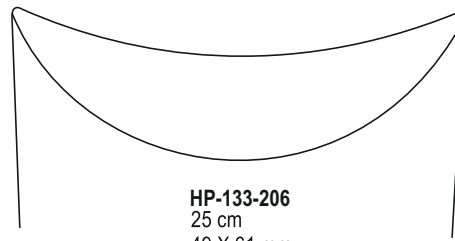

HP-133-206
25 cm
49 X 61 mm

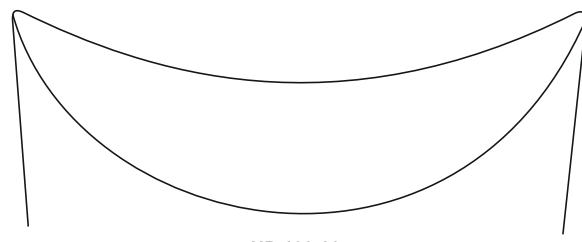

HP-133-207
25.5 cm
48 X 75 mm

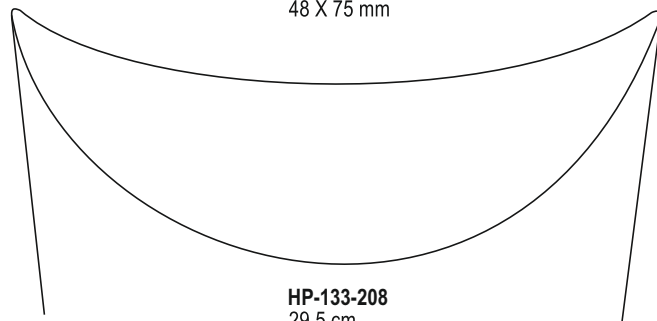

HP-133-208
29.5 cm
65 X 85 mm



½

Kocher
HP-134-209
23.5 cm
70 X 25 mm

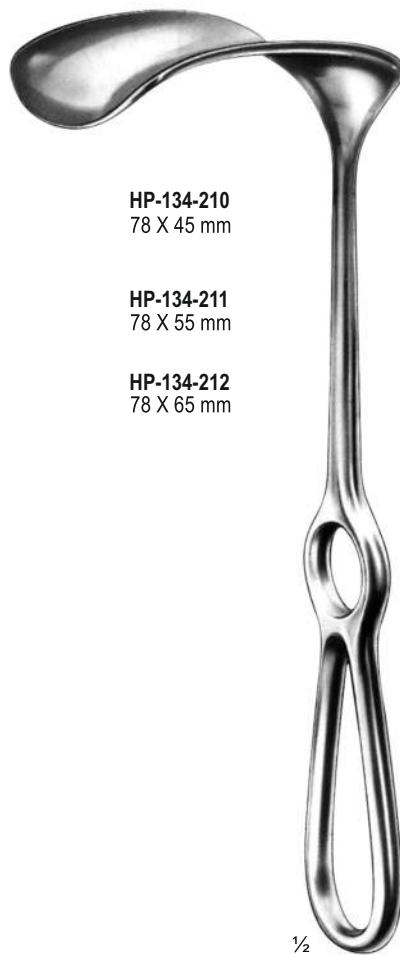

HP-134-210
78 X 45 mm

HP-134-211
78 X 55 mm

HP-134-212
78 X 65 mm

½

Kocher
HP-134-210 - HP-134-212
25 cm



½

Doyen
HP-134-213
24 cm
45 X 88 mm

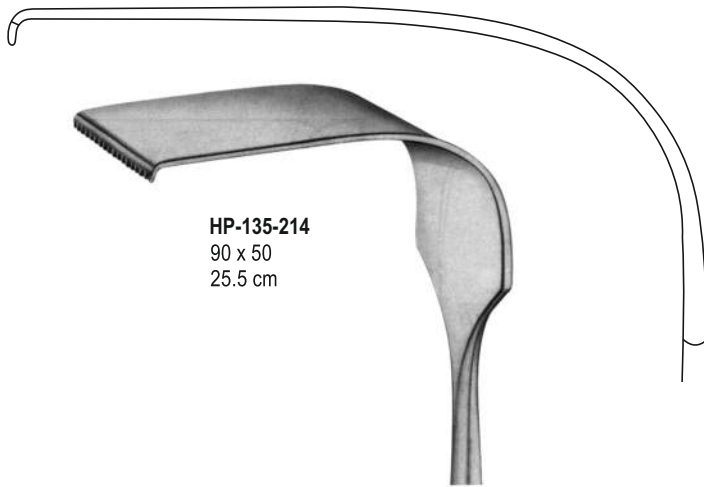

HP-135-214
90 x 50
25.5 cm

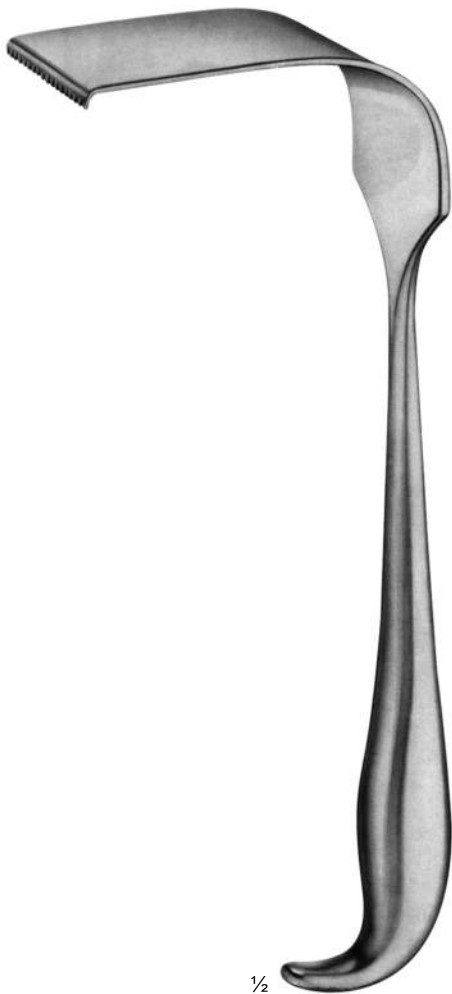

1/2

Meyerding
HP-135-214 - HP-135-216
26 cm



HP-135-215
75 x 25
23 cm



HP-135-216
52 x 16
21 cm

1/4



Sauerbruch
HP-136-217
25.5 cm

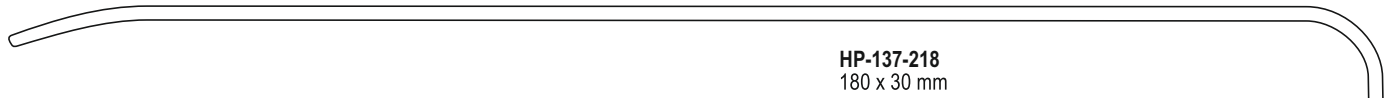

HP-137-218
180 x 30 mm

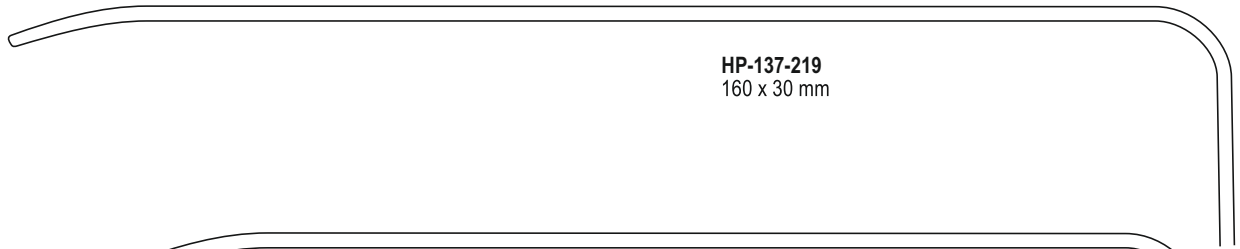

HP-137-219
160 x 30 mm

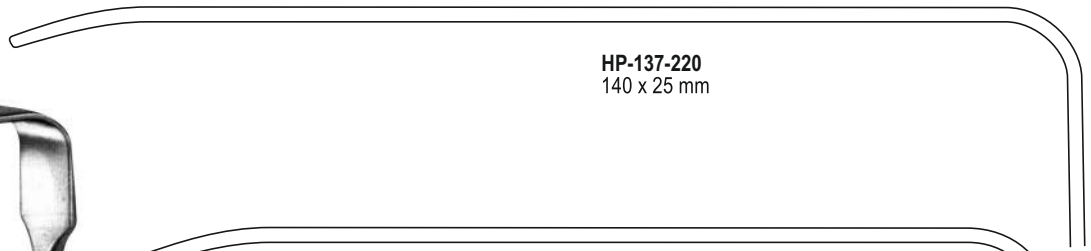

HP-137-220
140 x 25 mm

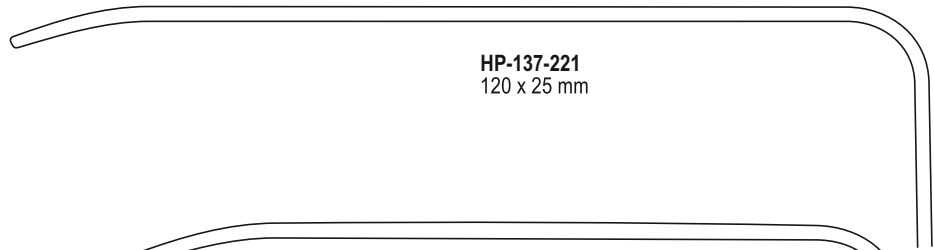

HP-137-221
120 x 25 mm

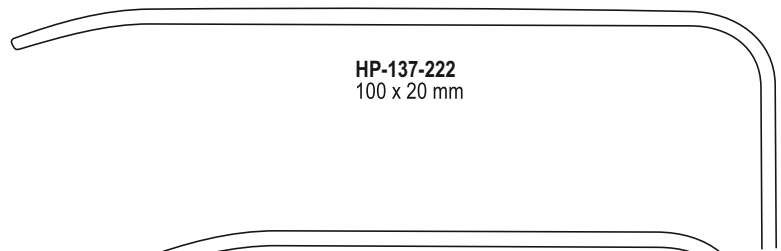

HP-137-222
100 x 20 mm

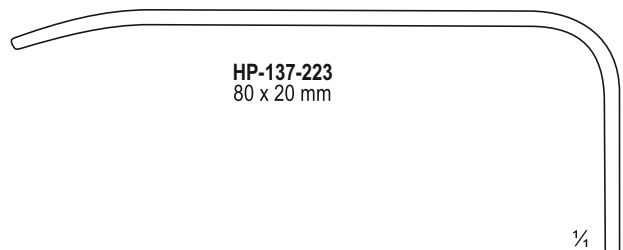

HP-137-223
80 x 20 mm



1/2

Brunner
HP-137-218 - HP-137-223
25.5 cm

1/4



1/2

Deaver
HP-138-224
18 cm
19 mm

1/2

Deaver
HP-138-225
21.5 cm
22 mm

1/2

Deaver
HP-138-226
21.5 cm
25 mm

1/2

Deaver
HP-138-227
30.5 cm
25 mm

1/2

Deaver
HP-138-228
33.5 cm
25 mm



½

Deaver
HP-139-229
34.5 cm
25 mm

½

Deaver
HP-139-230
32 cm
38 mm

½

Deaver
HP-139-231
31.5 cm
50 mm

½

Deaver
HP-139-232
31.5 cm
75 mm

Atrium Retractors

Atrium Retraktoren
Retratores de Átrio
Retradores de atrio



Cooley
HP-140-233
25 cm
Right
48 X 48 mm



Cooley
HP-140-234
25 cm
Right, Serrated
48 X 48 mm



Cooley
HP-140-235
27.5 cm
Left
30 X 48 mm

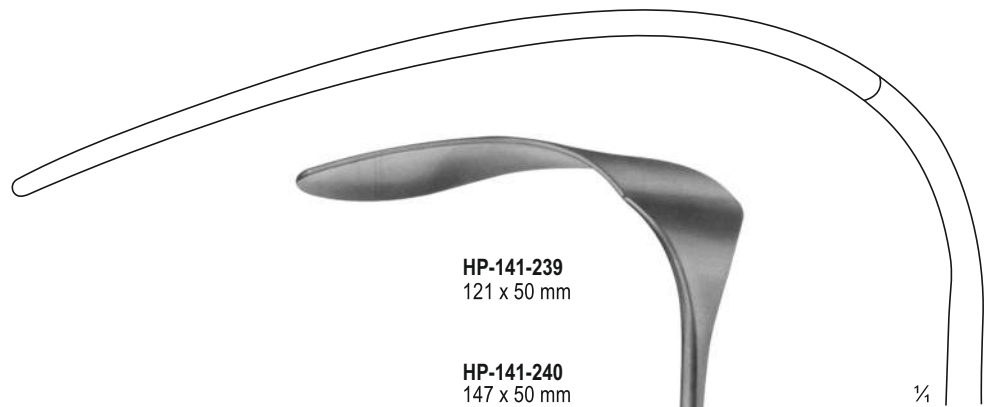

HP-141-239
121 x 50 mm

HP-141-240
147 x 50 mm

1/4

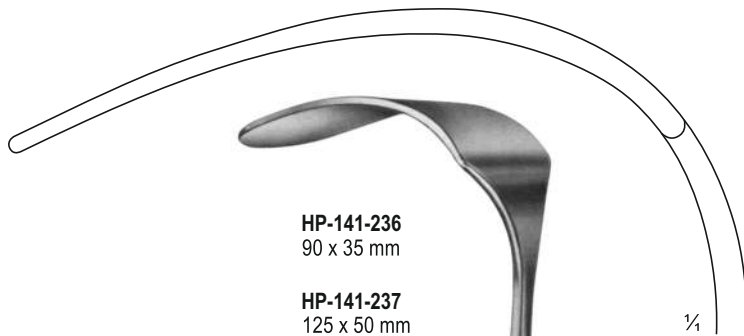

HP-141-236
90 x 35 mm

HP-141-237
125 x 50 mm

HP-141-238
160 x 50 mm

1/4

1/2

Mikulicz
HP-141-239 - HP-141-240
25 cm
Liver retractor

1/2

Mikulicz
HP-141-236 - HP-141-238
25 cm

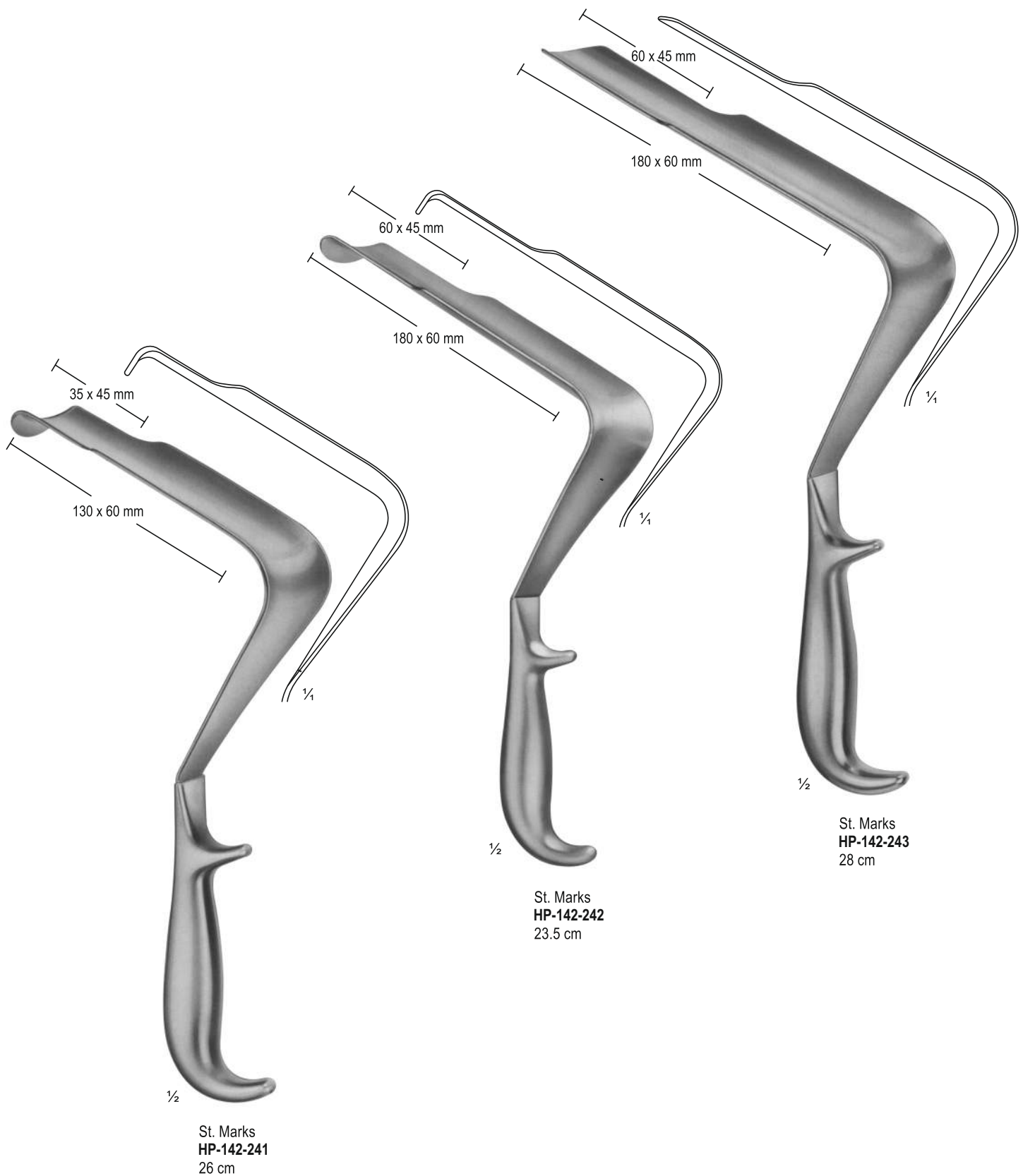

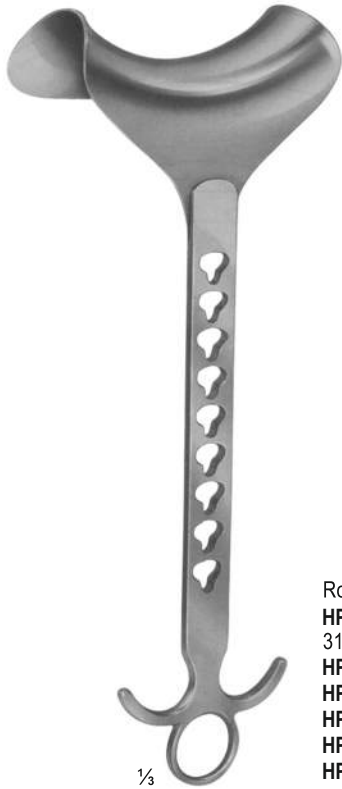

Rochard
HP-143-244 - HP-143-248
 31 cm
HP-143-244 48 x 90 mm
HP-143-245 48 x 105 mm
HP-143-246 48 x 120 mm
HP-143-247 48 x 135 mm
HP-143-248 48 x 155 mm



HP-143-249
 Rochard fixation device



Doyen
HP-143-250 - HP-143-253
 28 cm
HP-143-250 48 x 90 mm
HP-143-251 48 x 105 mm
HP-143-252 48 x 120 mm
HP-143-253 48 x 135mm



Doyen-Child
HP-143-254
 Fixation device
 22 cm



HP-143-255
 Chain with
 Weight (747 / 645g)
 79 cm
 For retractors

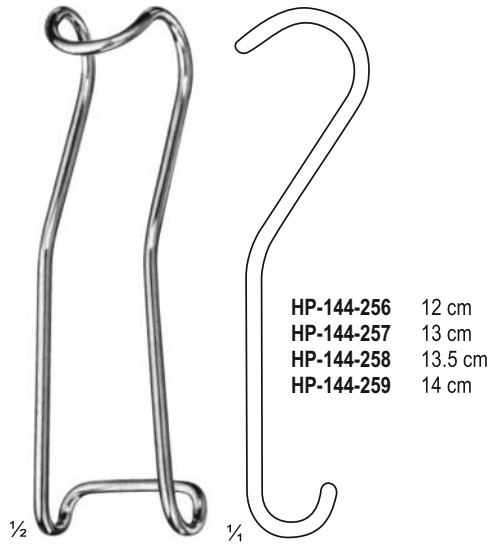

Sterberg
HP-144-256 - HP-144-259
14 cm
Lip and cheek retracor

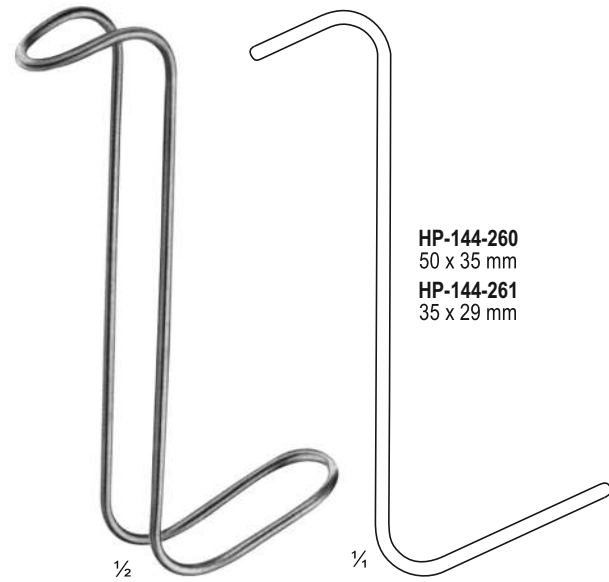

Collin-Hartmann
HP-144-260 - HP-144-261
15 cm

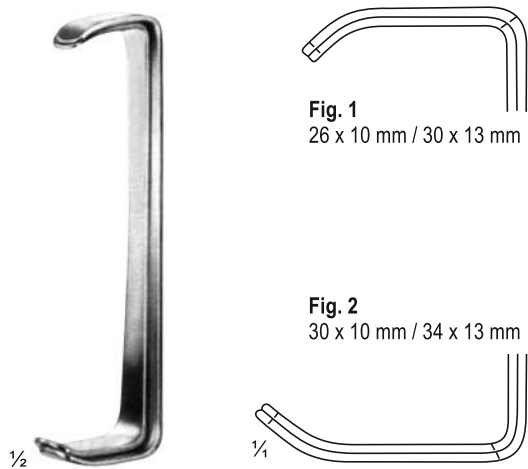

Farabeuf
HP-144-262
12 cm

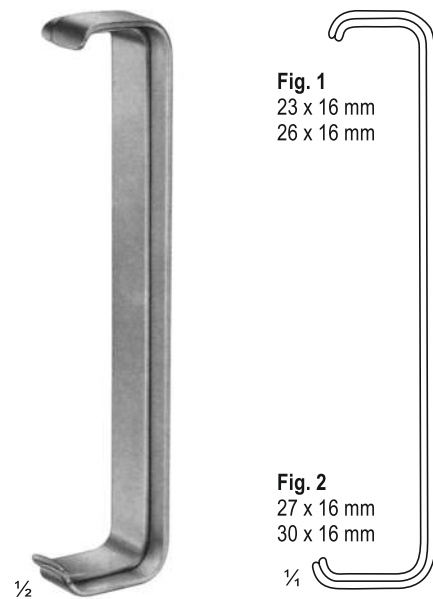

Farabeuf
HP-144-263
15.5 cm

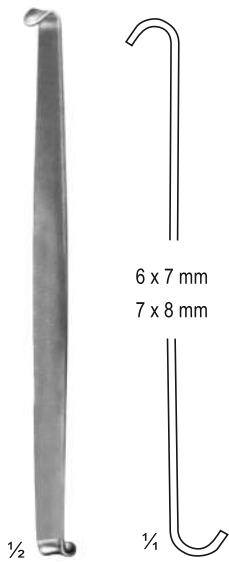

Roux-Mini
HP-145-264
14.5 cm

6 x 7 mm
7 x 8 mm

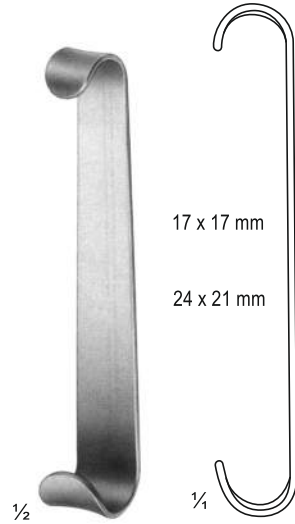

Roux-Baby
HP-145-265
12.5 cm

17 x 17 mm
24 x 21 mm



Roux
HP-145-266 - HP-145-267
15 cm

HP-145-266
20 x 22 mm
25 x 29 mm

HP-145-267
25 x 26 mm
30 x 38 mm



Roux
HP-145-271 Set
HP-145-268 - HP-145-271
17 cm

Fig. 1
HP-145-268
14.5 cm
22 x 21 mm
27 x 29 mm

Fig. 2
HP-145-269
16 cm
25 x 26 mm
30 x 38 mm

Fig. 3
HP-145-270
17 cm
28 x 29 mm
33 x 43 mm



Parker
HP-146-272
14 cm

Fig. 1
19 x 15 mm
19 x 15 mm

Fig. 2
22 x 15 mm
22 x 15 mm

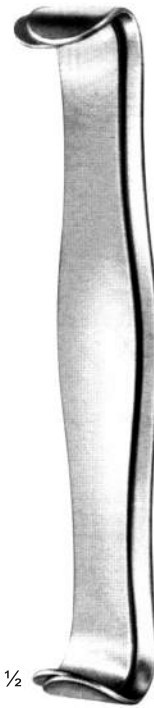
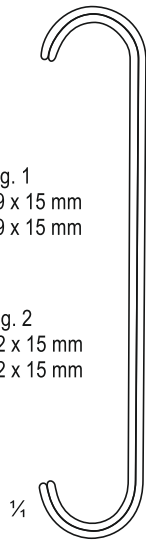

Parker
HP-146-273
18.5 cm

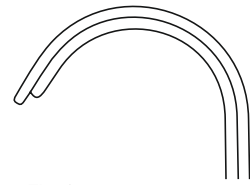
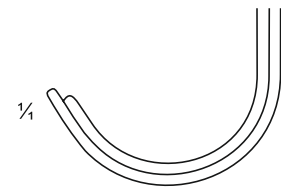

Fig. 1
26 x 25 mm / 27 x 15 mm

Fig. 2
29 x 25 mm / 27 x 25 mm



Parker-Mott
HP-146-274
16 cm

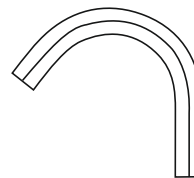
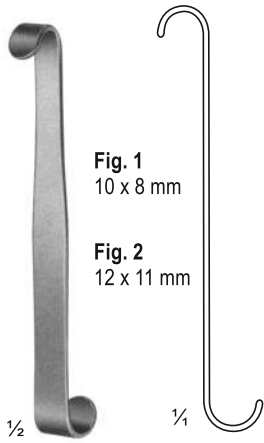

Fig. 1
21 x 24 mm
Fig. 2
25 x 24 mm

Fig. 1
68 x 24 mm
Fig. 2
72 x 24 mm





Luer
HP-147-275
11 cm

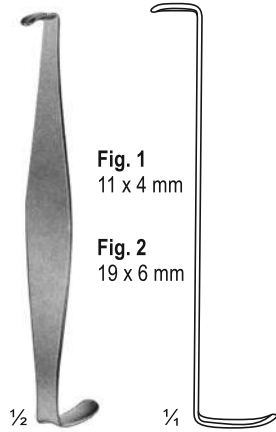

Crile
HP-147-276
11 cm

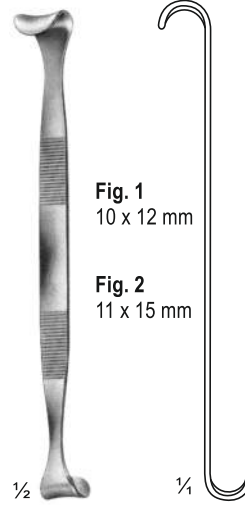

Rose
HP-147-277
13 cm

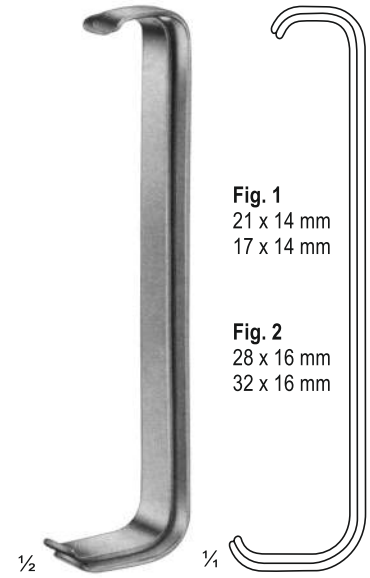

Collin
HP-147-278
15 cm
Double ended
set of 2

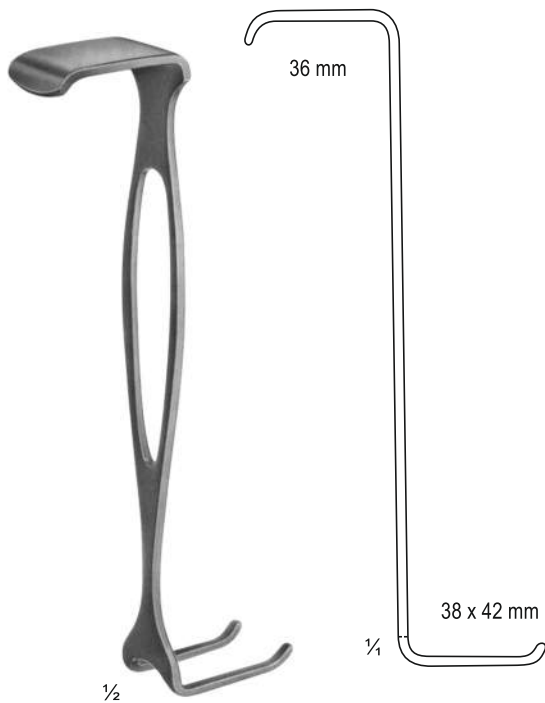

Czerny
HP-147-279
17.5 cm



Goelet
HP-147-280
19 cm

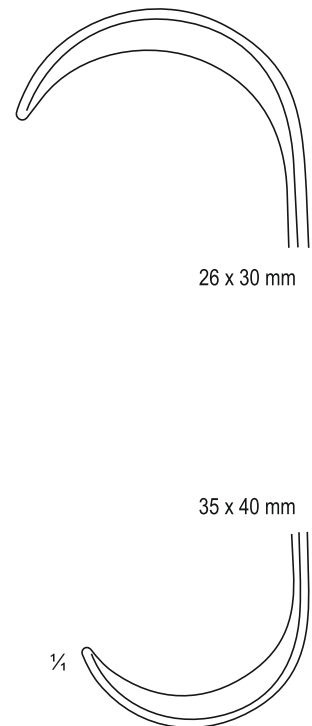

Self-retaining Retractors

Selbsthaltende Retraktoren
Retraçadores de auto-retenção
Retradores autosuficientes



Jansen
HP-148-281
10 cm

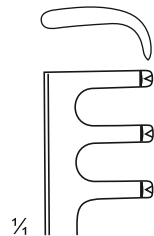

With adjusting screw
Sharp



Jansen
HP-148-282
10 cm

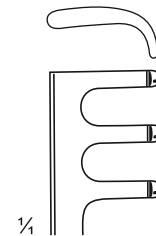

With adjusting screw
Blunt



Scalp-Contour
HP-148-283 - HP-148-284
13.5 cm

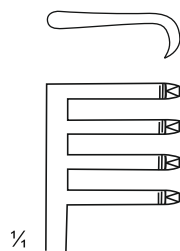

HP-148-283
Sharp

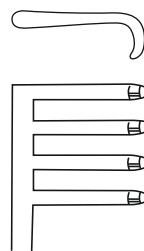

HP-148-284
Blunt

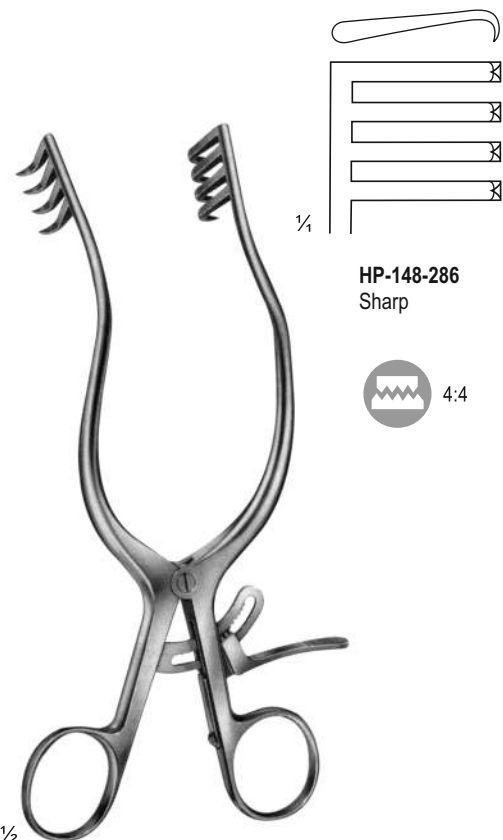

Anderson-Adson
HP-148-285
19 cm

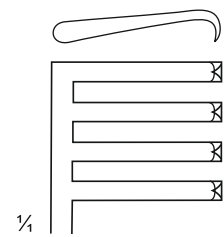

HP-148-285
Sharp





Travers
HP-149-287
21.5 cm
Blunt

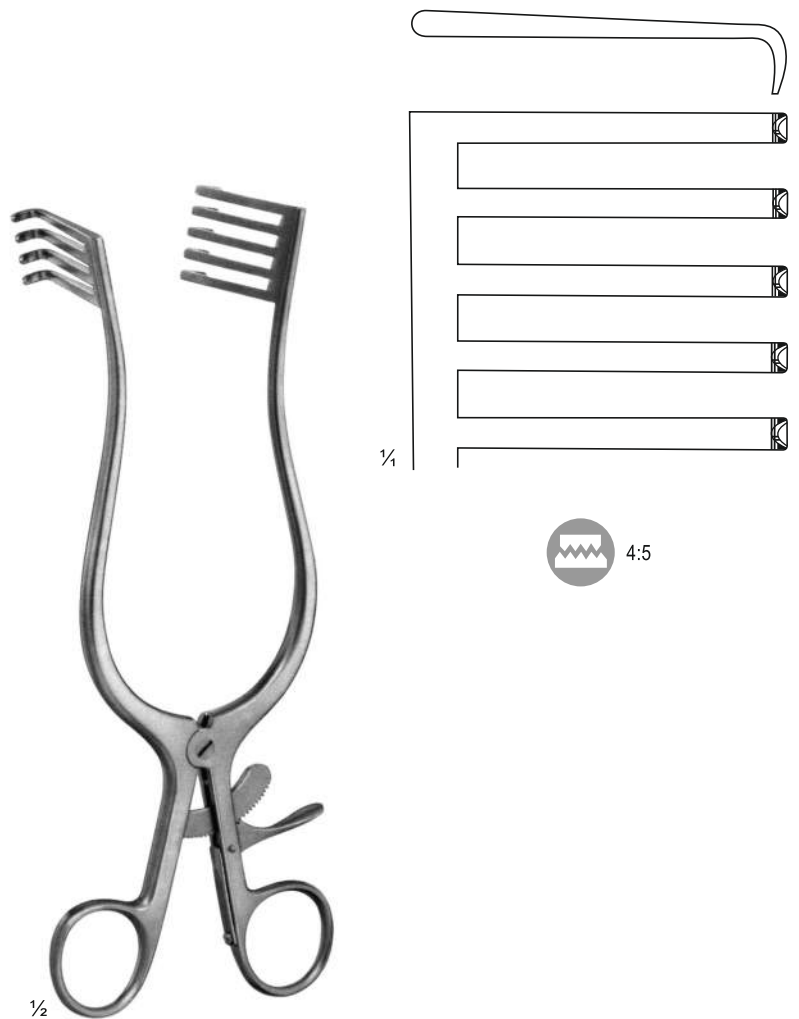

Norfolk-Norwich
HP-149-288
22 cm
Blunt

Self-retaining Retractors

Selbsthaltende Retraktoren
Retraçadores de auto-retenção
Retradores autosuficientes

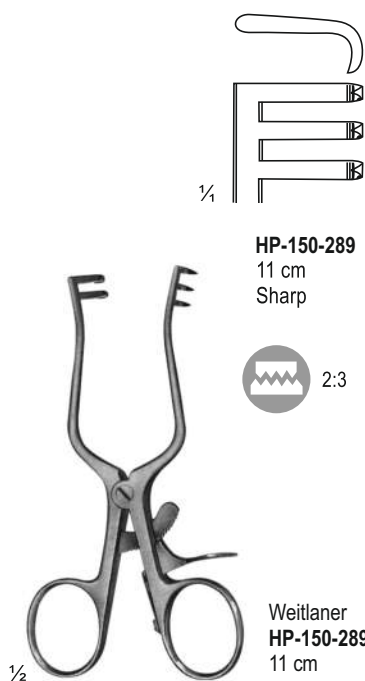

HP-150-289
11 cm
Sharp



2:3

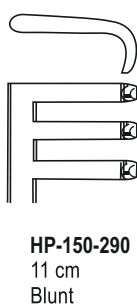

HP-150-290
11 cm
Blunt



2:3



HP-150-291
20 cm
Sharp



3:4

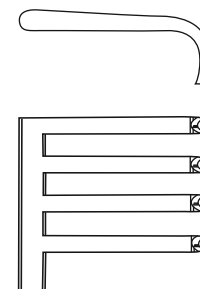

HP-150-292
20 cm
Blunt



3:4

Weitlaner
HP-150-291 - HP-150-292
20 cm

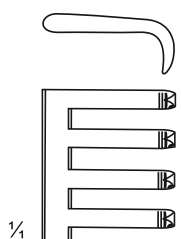

HP-150-293
13.5 cm
Sharp



3:4

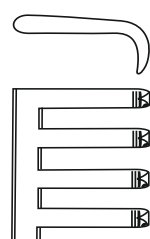

HP-150-294
16 cm
Sharp



3:4

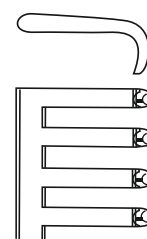

HP-150-295
13.5 cm
Blunt



3:4

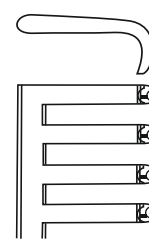

HP-150-296
16 cm
Blunt



3:4

Weitlaner
HP-150-293 - HP-150-296
16 cm

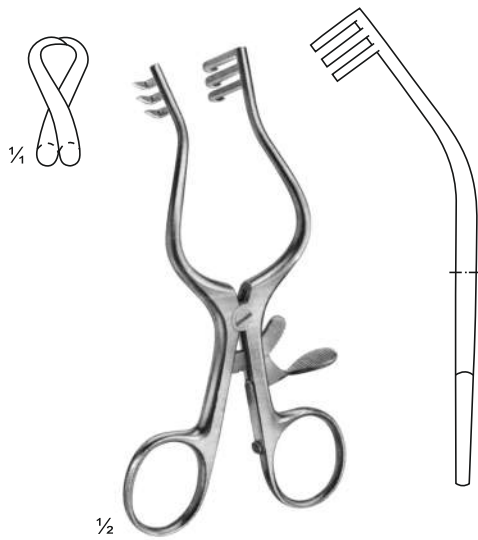

Wullstein
HP-151-297
 13 cm
 Sharp

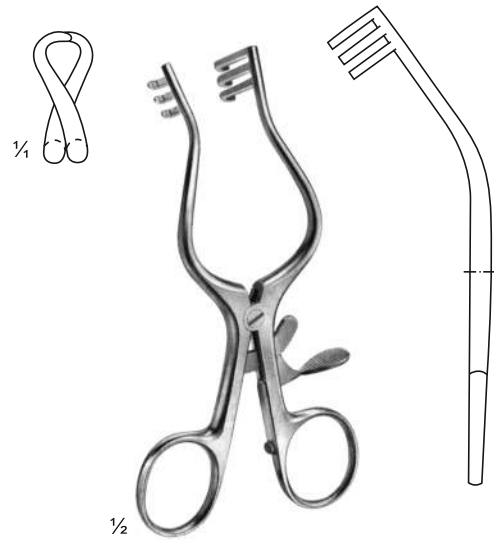

Wullstein
HP-151-298
 13 cm
 Blunt

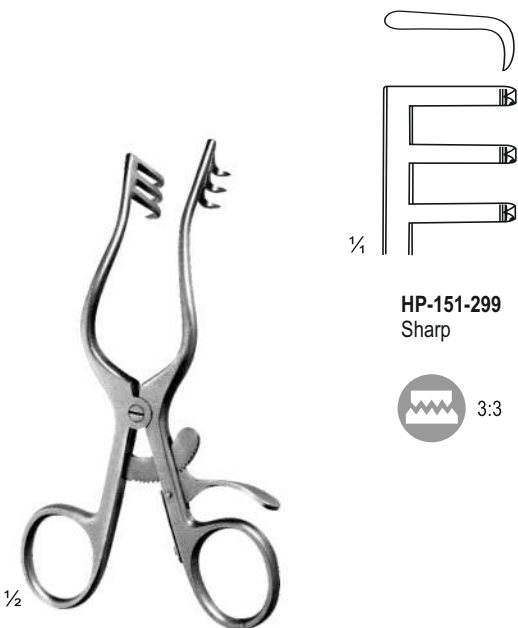

Weitlaner-Wullstein
HP-151-299 - HP-151-300
 13 cm
 Blunt

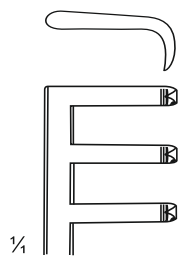

HP-151-299
 Sharp



3:3

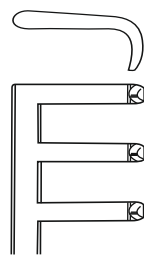

HP-151-300
 Blunt



3:3

Self-retaining Retractors
Selbsthaltende Retraktoren
Retraçadores de auto-retenção
Retradores autosuficientes



1/2

Henley
HP-152-301 - HP-152-302
16.5 cm
Complete with 3 central blades
ref. 06-540-19, - 25 and 32

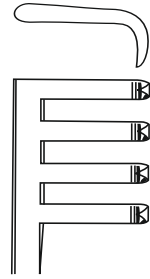

HP-152-301
Sharp

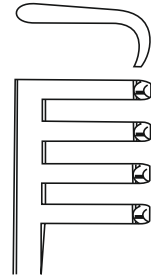

HP-152-302
Blunt

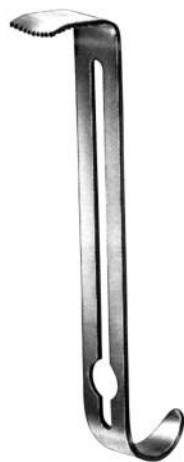

Blades
19 X 17 mm

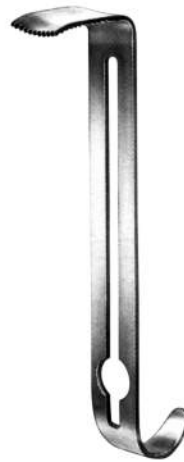

Blades
25 X 17 mm

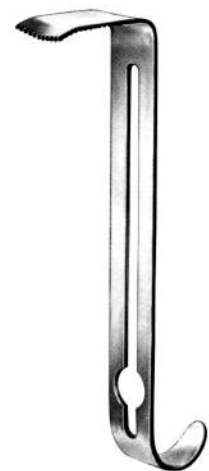

Blades
32 X 17 mm

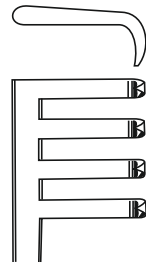

HP-153-303
 14 cm
 Sharp

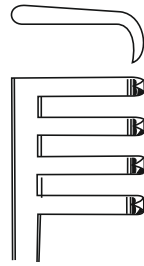

HP-153-304
 16.5 cm
 Sharp

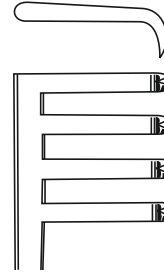

HP-153-305
 21 cm
 Sharp

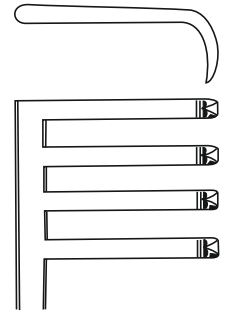

HP-153-306
 24.5 cm
 Sharp

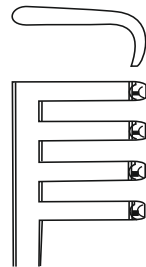

HP-153-307
 14 cm
 Blunt

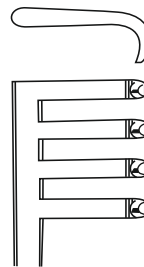

HP-153-308
 16.5 cm
 Blunt

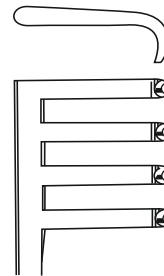

HP-153-309
 21 cm
 Blunt

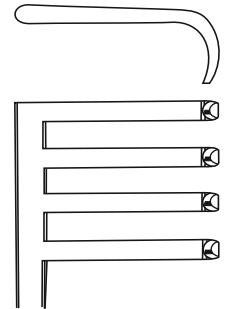

HP-153-310
 24.5 cm
 Blunt



Adson
 HP-153-303 - HP-153-310

Self-retaining Retractors, Vaginal Retractors

Selbsthaltende Retraktoren, vaginale Retraktoren
Retratores auto-retentivos, retratores vaginais
Retradores autorretenidos, retradores vaginales



1/2
Joll
HP-154-311
15.5 cm
Thyroid and vaginal retractor



1/2
Gelpi
HP-154-312
13 cm

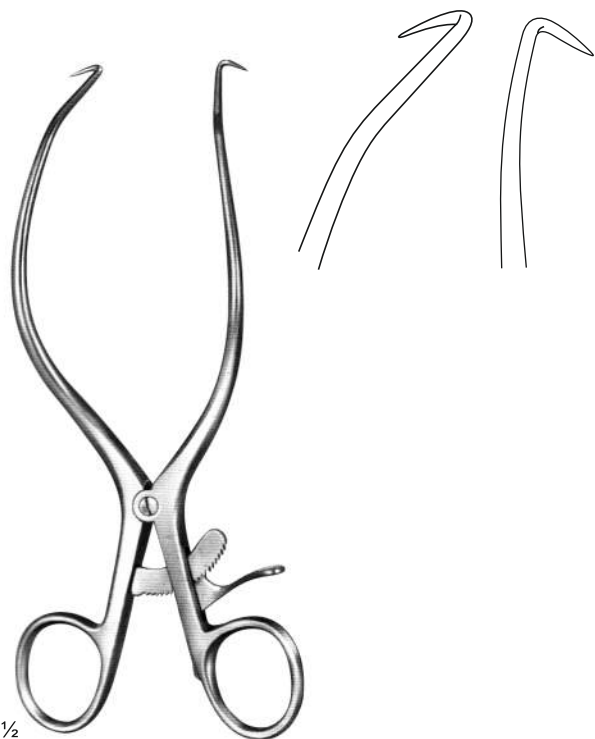

1/2
Gelpi
HP-154-313
18 cm

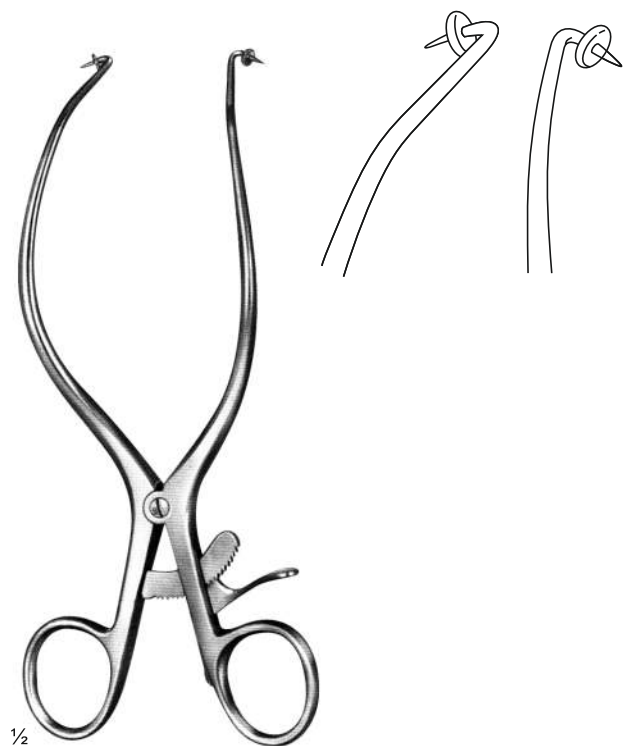

1/2
Gelpi
HP-154-314
18.5 cm

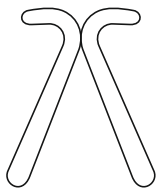

Jackson Burrows
HP-155-315
18.5 cm
Retractor, blunt

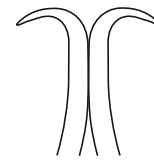

DeBakey
HP-155-316
14.5 cm

Abdominal Retractors
Bauch-Reraktoren
Retratores abdominais
Retradores abdominales



Collin Baby
HP-156-317
20 cm
Complete, with 2 pair of lateral blades
18 x 40 mm and 27 x 40 mm
Spreading
80 mm



Collin
HP-156-318
24 cm
Complete, with 1 pair of lateral blades
38 x 60 mm
Spreading
80 mm

HP-157-319
Central blade

HP-157-320
Central blade



Collin
HP-157-319 - HP-157-320
22.5 cm

Complete, with 1 pair of lateral blades
38 x 60 mm and central blade 38 x 55 mm
Spreading
85 mm

HP-157-319
22.5 cm

Complete, with 1 pair of lateral blades
45 x 80 mm and central blade 50 x 75 mm
Spreading
80 mm

HP-157-321
Central blade



Collin
HP-157-321
31 cm

Complete, with 1 pair of lateral blades
60 x 80 mm and central blade 60 x 75 mm
Spreading
130 mm

Abdominal Retractors
Bauch-Reraktoren
Retratores abdominais
Retradores abdominales



1/2

Gosset-Baby
HP-158-322
12.5 cm

Lateral blades (40 X 30 mm)
Spreading
120 mm



Central blade
HP-158-324
60 x 56 mm

Gosset
HP-158-323 - HP-158-324
16.5 cm

Lateral blades 63 X 35 mm
Spreading
160 mm

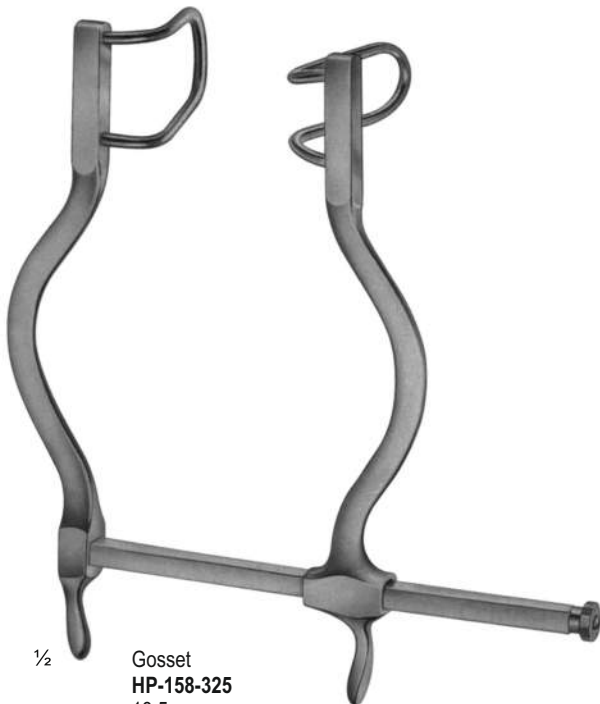

1/2

Gosset
HP-158-325
18.5 cm

Lateral blades (63 X 65 mm)
Spreading
140 mm



Hertzier
HP-158-326
Blades
20 x 25 mm



Balfour-Baby
HP-159-327
 12.5 cm
 Center blade 24 x 20 mm

Spreading
 95 mm

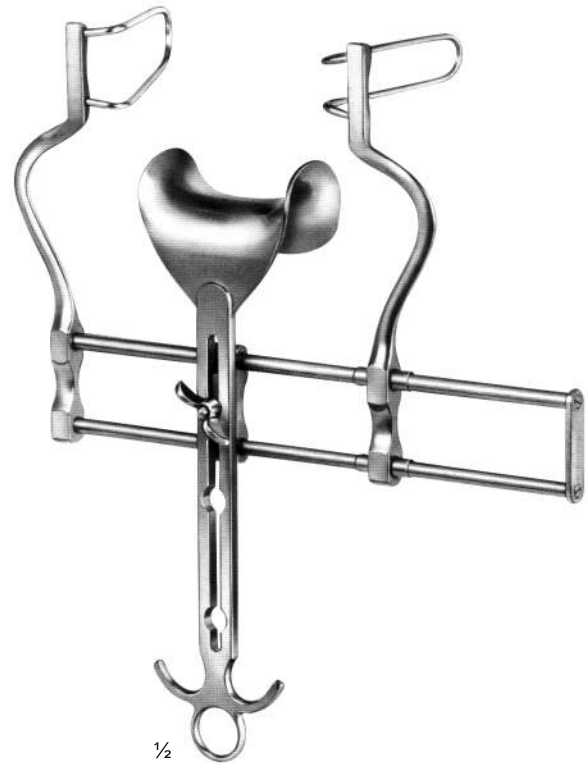

Balfour
HP-159-328
 20 cm
 Lateral blades (70 x 35 mm)
 Spreading
 180 mm

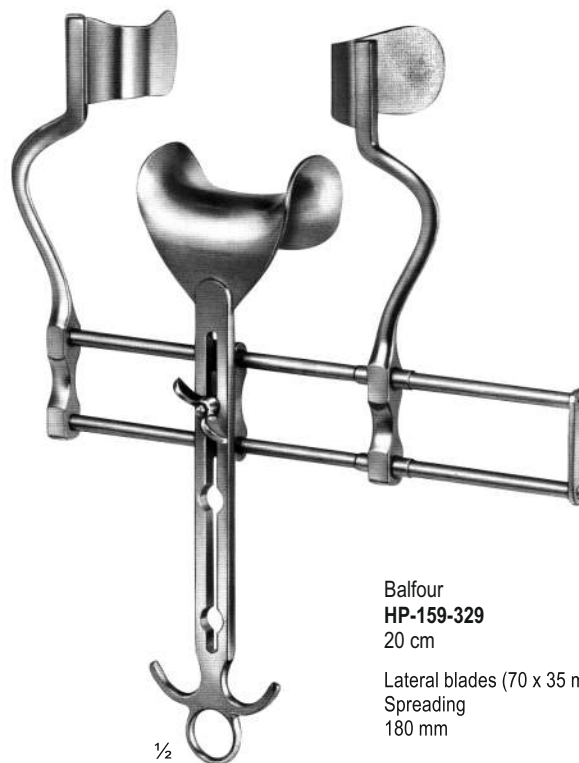

Balfour
HP-159-329
 20 cm
 Lateral blades (70 x 35 mm)
 Spreading
 180 mm

Abdominal Retractors
Bauch-Reraktoren
Retratores abdominais
Retradores abdominales



½

Balfour
HP-160-330
20 cm

Lateral blades (100 x 35 mm)
Center blade (100 x 60 mm)
Spreading
200 mm

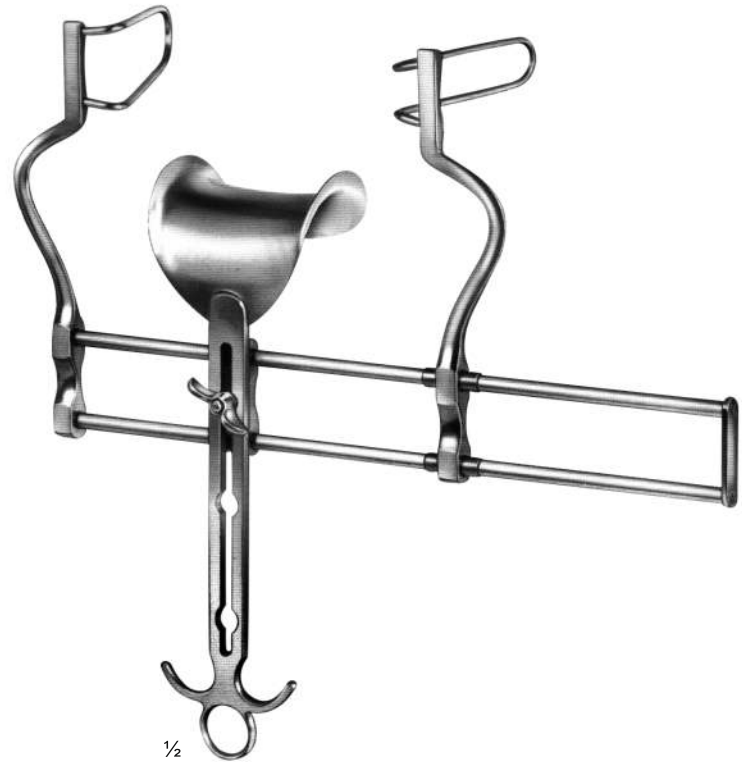

½

Balfour-Standard
HP-160-331
20 cm

Lateral blades (100 x 35 mm)
Spreading
250 mm

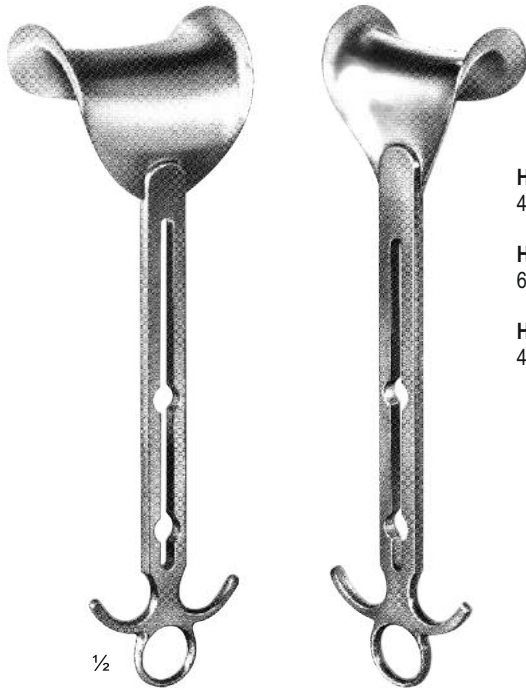

HP-161-332
45 x 80 mm

HP-161-333
68 x 85 mm

HP-161-334
40 x 68 mm

1/2

Balfour
HP-161-332 - HP-161-334
 20 cm
 Center blades only



1/2

Balfour, Mod. USA
HP-161-335 - HP-161-337
 20 cm

HP-161-337
 With 1 pair each lateral blades
 Spreading
 190 mm



HP-161-335
 6 cm
 Fenestrated blades
 60 mm deep (pair)



HP-161-336
 8 cm
 Fenestrated blades
 80 mm deep (pair)

Abdominal Retractors

Bauch-Reraktoren
Retratores abdominais
Retradores abdominales

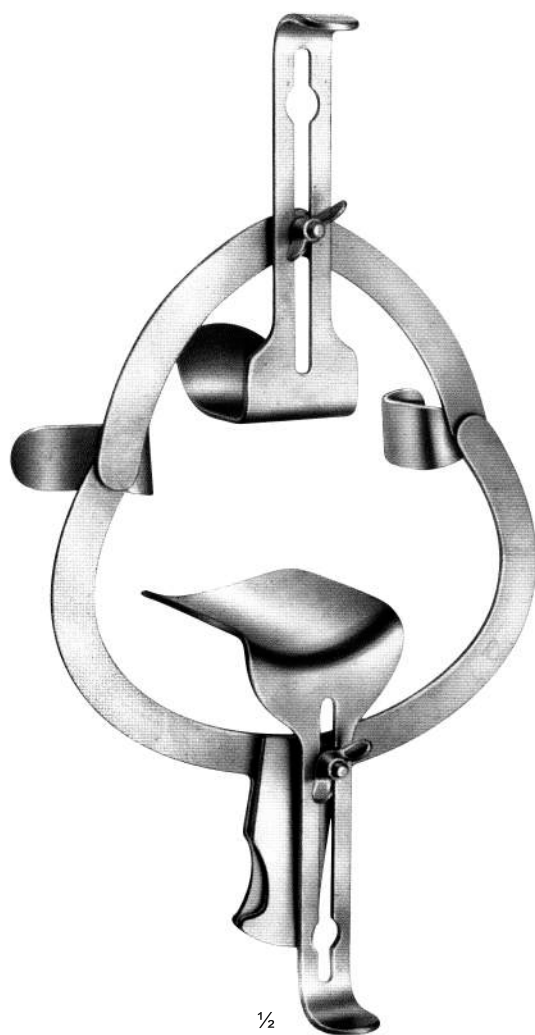

Central blade
HP-162-338
80 x 45 mm

Central blade
HP-162-339
110 x 70 mm

1/2

O'Sullivan-O'Connor
HP-162-338 - HP-162-339

With 2 fixed lateral blades, 1 blade (110 x 70 mm) and 2 blades 80 x 45 mm

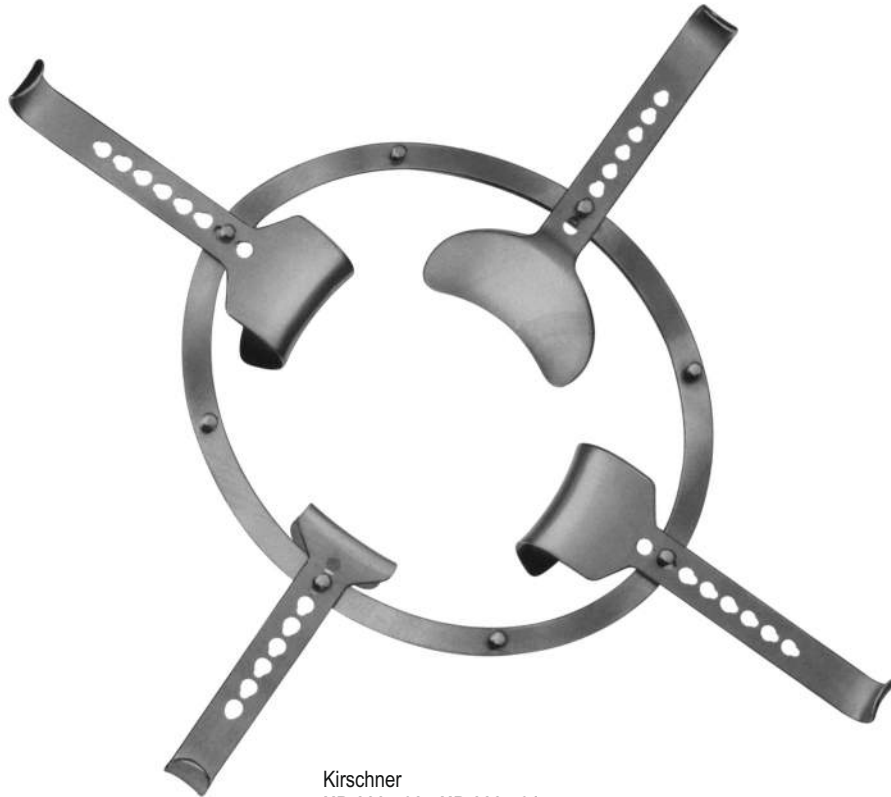

Kirschner
 HP-228-532 - HP-228-531

Frame 3 hooks
 1 hooks each

Kirschner
 HP-228-533
 Frame, only
 330 x 270 mm

Blades

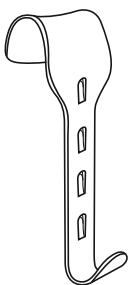

HP-228-534
 40 x 55 mm
 Standard

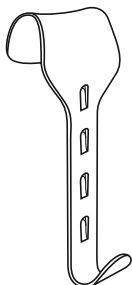

HP-228-535
 50 x 65 mm
 Standard

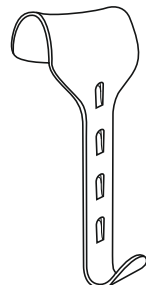

HP-228-536
 60 x 85 mm
 Standard

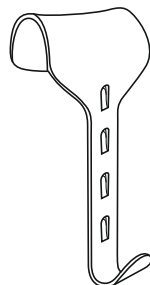

HP-228-537
 78 x 65 mm

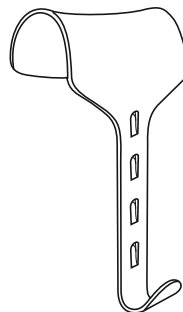

HP-228-538
 80 x 90 mm

For obese Patients

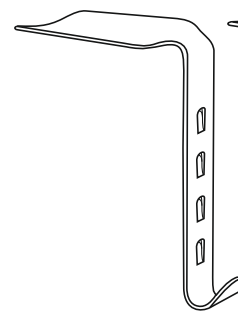

HP-228-539
 98 x 50 mm

For intestine and bladder

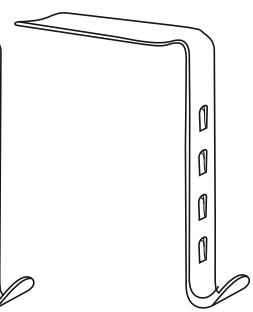

HP-228-540
 105 x 35 mm

Abdominal Retractors
Bauch-Retraktoren
Retratores abdominais
Retradores abdominales



Kirschner
HP-229-541 - HP-229-543

HP-229-541
Frame, only
240 x 240 mm

Frame ref. HP-229-541, 2 hooks
ref. HP-228-542 and 2 hooks ref. HP-228-543

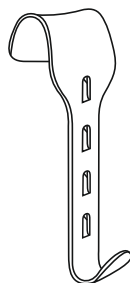

Kirschner
HP-229-541
40 x 55 mm

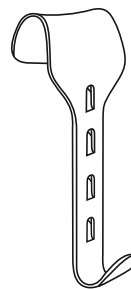

Kirschner
HP-229-541
40 x 55 mm

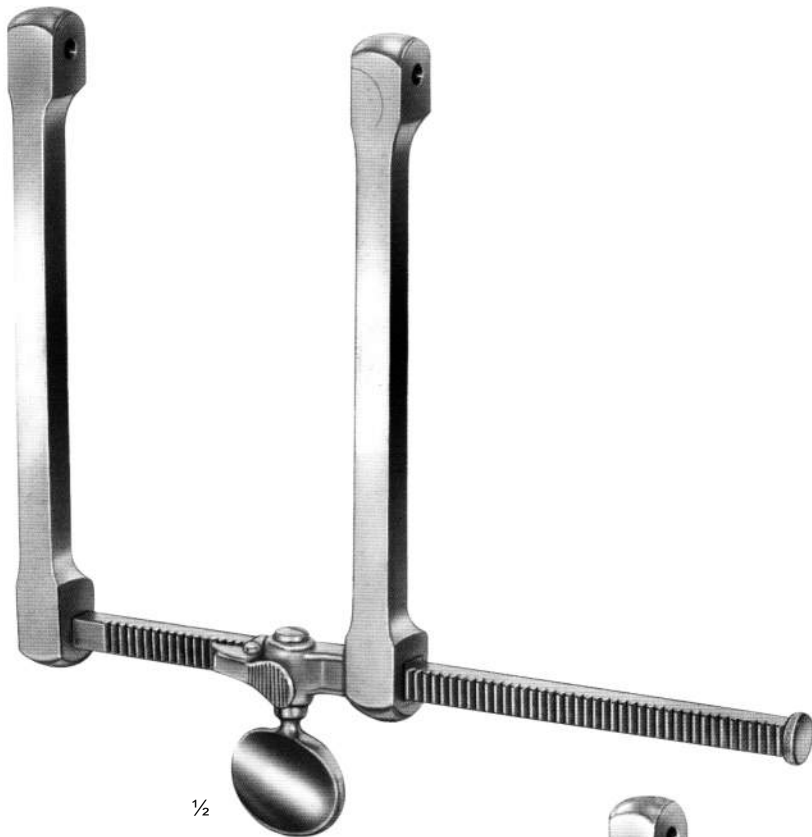

1/2

Scoville
HP-230-544
22 cm
Spreading
190 mm

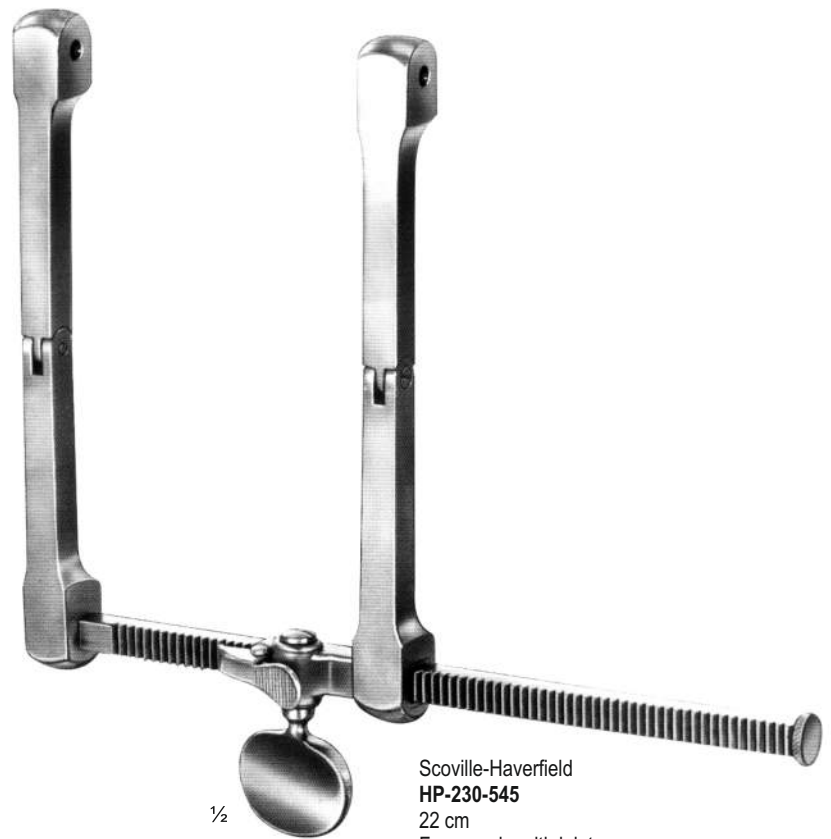

1/2

Scoville-Haverfield
HP-230-545
22 cm
Frame only, with joint
Spreading
190 mm

Laminectomy Retractors

Laminektomie Retraktoren
Retratores de laminectomia
Retradores de laminectomia



1/2

HP-231-546
5 cm
Hook, piece
50 mm deep, blunt



1/2

HP-231-547
7 cm
Hook, piece
70 mm deep, blunt



1/2

HP-231-548
5 cm
Hook, piece
50 mm deep, sharp



1/2

HP-231-549
7 cm
Hook, piece
70 mm deep, sharp



1/2

HP-231-550 60 x 25 mm
HP-231-551 61 x 50 mm
HP-231-552 86 x 25 mm

Blades, piece
toothed



1/2

HP-231-553 48 x 50 mm
HP-231-554 64 x 50 mm
HP-231-555 64 x 64 mm
HP-231-556 80 x 57 mm

Hook, piece
Sharp

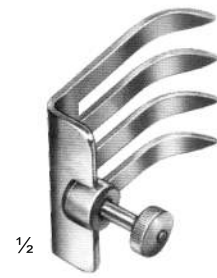

1/2

HP-231-557 44 x 38 mm
HP-231-558 67 x 44 mm

Hook, piece
Sharp



1/2

Tuffier
HP-233-559
20 cm
Malleable



1/2

Haberer
HP-233-560 - HP-233-562
Tapered

HP-233-560
20 cm
16 mm - 25 mm

HP-233-561
28 cm
25 mm - 30 mm

HP-233-562
30 cm
37 mm - 45 mm



1/2

HP-233-563 - HP-233-565
33 cm
Malleable

HP-233-563
33 cm
30 mm

HP-233-564
33 cm
40 mm

HP-233-565
33 cm
50 mm



1/2

Reverdin
HP-233-566
28.5 cm



Probes

Sonden
Sondas
Sondas

Page 169-171

Dissecting Forceps

Präparierzange
Pinça de dissecação
Pinzas de disección

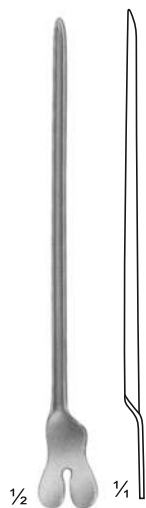

HP-169-001 - HP-169-003
HP-169-001 13 cm
HP-169-002 14.5 cm
HP-169-003 16 cm
Grooved directors

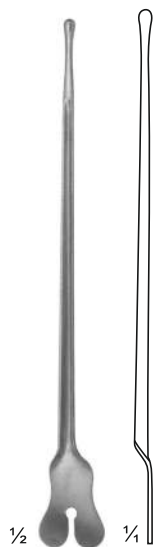

HP-169-004 - HP-169-006
HP-169-004 13 cm
HP-169-005 14.5 cm
HP-169-006 16 cm
Grooved directors with tip diam. of tip 3.3 mm

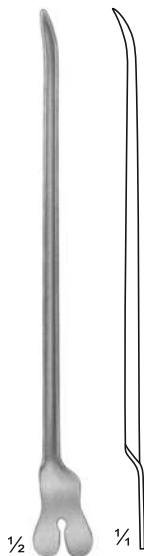

Doyen
HP-169-007
14.5 cm
Grooved directors

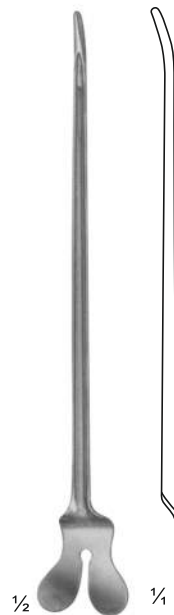

Nelaton
HP-169-008
16 cm
Grooved directors



Brodie
HP-169-009
Grooved director with tip, diam. of tip 3,5 mm
20 cm

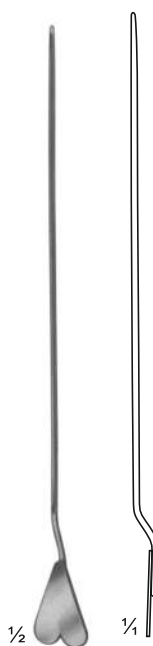

Lockhart-Mummery
HP-169-010
16.5 cm
Fistula probe

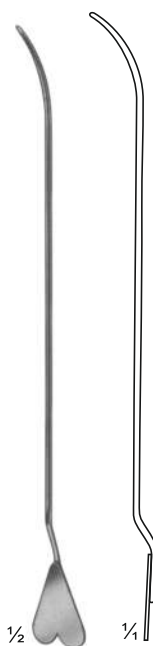

Lockhart-Mummery
HP-169-011
16.5 cm
Fistula probe

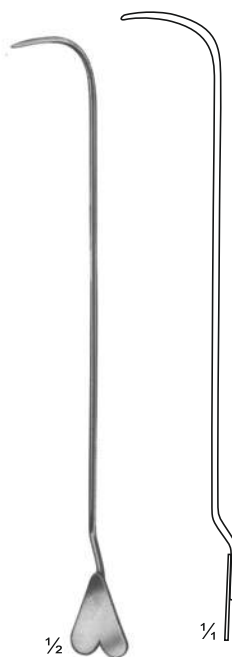

Lockhart-Mummery
HP-169-012
16.5 cm
Fistula probe

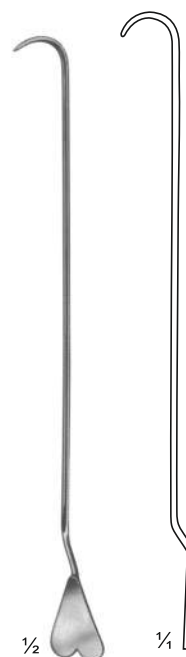

Lockhart-Mummery
HP-169-013
16.5 cm
Fistula probe



HP-169-014
Grooved director with wire loop, malleable 19 cm

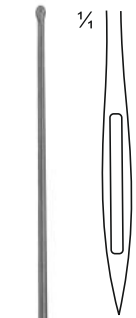

HP-170-015 13 cm
HP-170-016 14.5 cm
HP-170-017 16 cm

Probes
HP-170-015 - HP-170-017
With eye
Ø 2 mm



HP-170-018 13 cm
HP-170-019 14.5 cm
HP-170-020 16 cm

Probes
HP-170-018 - HP-170-020
Myrtle leaf probe
Ø 1.5 mm



HP-170-021 13 cm
HP-170-022 14.5 cm
HP-170-023 16 cm
HP-170-024 18 cm
HP-170-025 20 cm

Probes
HP-170-021 - HP-170-025
Myrtle leaf probe
Ø 2 mm



HP-170-026 11.5 cm
HP-170-027 13 cm
HP-170-028 14.5 cm
HP-170-029 16 cm
HP-170-030 18 cm
HP-170-031 20 cm

Probes
HP-170-026 - HP-170-031
Ø 1 mm



HP-170-032 13 cm
HP-170-033 14.5 cm
HP-170-034 16 cm
HP-170-035 18 cm
HP-170-036 20 cm
HP-170-037 25 cm

Probes
HP-170-032 - HP-170-037
Ø 1.5 mm



HP-170-038 11.5 cm
HP-170-039 13 cm
HP-170-040 14.5 cm
HP-170-041 16 cm
HP-170-042 18 cm
HP-170-043 20 cm
HP-170-044 25 cm
HP-170-045 30 cm

Probes
HP-170-038 - HP-170-045
Ø 2 mm



Double ended probe,
malleable, diam. of tips
3 mm with hole

Probes
HP-170-046
19 cm



Double ended probes,
tin, malleable,
diam. of tips
3.5 mm with hole

Probes
HP-170-047
25 cm



Double ended probes,
tin, malleable,
diam. of tips 4 mm

Probes
HP-170-048
40 cm



HP-170-049 Ø 1.5 mm
HP-170-050 Ø 2 mm
HP-170-051 Ø 2.5 mm

Probes
HP-170-049 - HP-170-051
30 cm

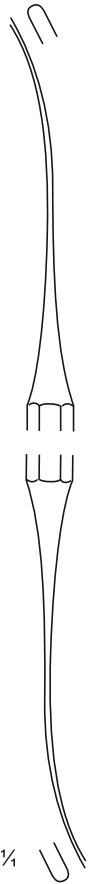

HP-171-052
18 cm
Phlebotomist



HP-171-053
18 cm
Phlebotomist



HP-171-054
18 cm
Phlebotomist

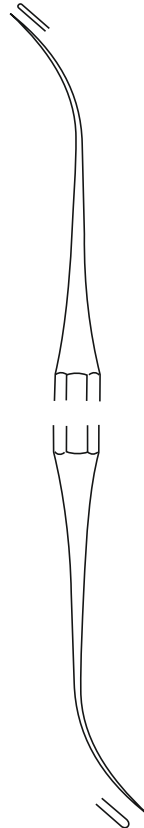

HP-171-055
17 cm
Micro dissector

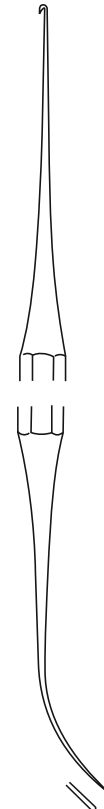

HP-171-056
17 cm
Micro dissector

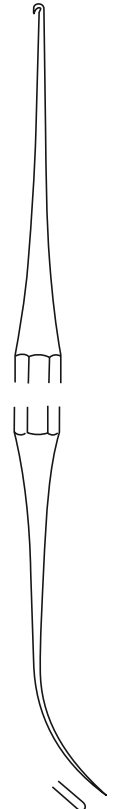

HP-171-057
17 cm
Mini phlebotomist



Varady
HP-171-052 - HP-171-057



Diagnosics

Diagnose

Diagnóstico

Diagnostico

Page 172-180

Percussion Hammers
Perkussion Hämmer
Martelos de Percussão
Martillos de percusión

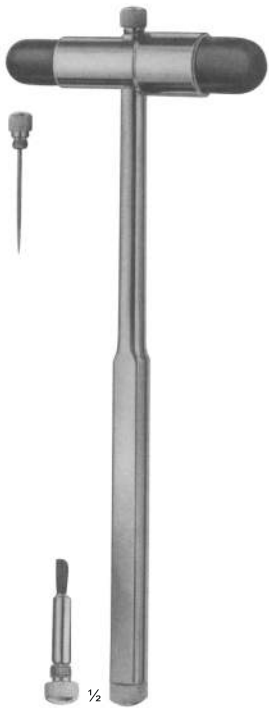

Buck
HP-172-001
With needle
and brush
18.5 cm



Dejerine
HP-172-002
20 cm



Dejerine
HP-172-003
with needle
21 cm



Taylor, Mod. USA
HP-172-004
20 cm

Percussion Hammers Fetoscopes
 Perkussion Hämmer Fetoskope
 Martelos de Percussão Fetoscópios
 Fetoscopios de martillos de percusión



1/2
 Berliner
HP-173-005
 20 cm



1/2
 Wartenberg
HP-173-006
 Pinwheel for
 neurological
 examination
 18.5 cm



1/2
 Troemner
HP-173-007
 24.5 cm



1/2
 Babinski / Rabiner
HP-173-008
 With needle
 and brush
 25.5 cm



1/2
 Pinard
HP-173-009
 Aluminum
 15 cm
 Fetoscopes



1/2
 Pinard
HP-173-010
 Wooden
 18 cm
 Fetoscopes

Calipers, Flexometer
Messschieber, Flexometer
Pinças, Flexômetro
Calibradores, Flexómetro



Jameson
HP-174-011
Caliper
graduated in mm
and inches

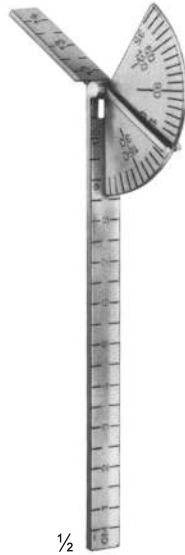

Carroll
HP-174-012
14.5 cm
Finger Goniometer



Townley
HP-174-013
11.5 cm
Caliper
graduated in mm and inches



Möltgen
HP-174-014
Flexometer
for extremities



Bertillon
HP-174-015
Caliper for measuring the head
32 cm



Castroviejo
HP-174-016
8 cm
Caliper
effective range 0-15 mm



Iwanson
Metal: **HP-174-017**
Wax : **HP-174-018**
Caliper double side marking



1/2

Boley
HP-175-019
14 cm



1/2

HP-175-020
23.5 cm
Graduated in mm and inches,
measuring range up to 150 mm



1/2

HP-175-021
22.5 cm
Graduated in mm and inches,
measuring range up to 145 mm

Metal, Standard Otoscopes

Metall, Standard-Otoskope

Metal, Otoscopios Standard

Metal, Otoscopios Estándar



HP-176-022

Fiber Optical
(Pocket Style)

2.5v LED

Modern pocket otoscope compact design. Handy and powerful. Distal Fiber-Optic (F.O.) illumination 4mm bundle with Enhanced LED Technology.

Attachment clip with integrated on/off switch.

Power Supply: 2x AA Batteries (not included in set).

Packing: In Gray or Black pouch with 10 disposable Specula Dia 2.5mm & 4.0 mm

Available Colours: Blue, Green, Brown, Red



HP-176-023

Conventional
(Plastic Head Otoscope)

2.5v LED

Equipped with an easy to use Bayonet connecting system with high quality plastic head. Chrome plated knurled battery handle makes surface, a secure grip in the hand. Extra bright light of 2.5v LED bulb illumination.

3 X High Quality magnifying Lens.

Power Supply: 2x AA Batteries (not included in set).

Packing: In Gray or Black pouch / plastic box with 10 disposable Specula Dia 2.5mm & 4.0 mm

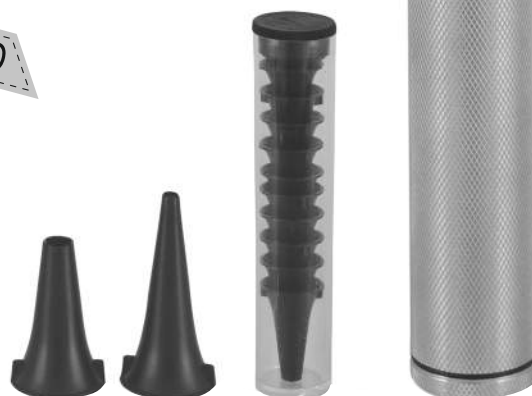



HP-177-024

(Ophthalmoscope)

2.5v LED lamp light for true tissue color and consistent long lasting illumination 16 color coded lenses - 25 to + 25 for excellent resolution (Red for - Black for +) 4 different apertures (small, large, blue, half moon focus) Rubber eye brow rest to prevent scratching of eye-glasses illumination lens dial for clear identification of adopter setting.

Power Supply: 2 x AA Batteries (not included in set).

Packing: Hard plastic case packing.



HP-177-025

(Ophthalmoscope)

Parker mini Ophthalmoscope with 2.5v LED bulb light for true tissue color and consistent long lasting illumination 24 color coded lenses - 25 to + 40 for excellent resolution (Red for - Green for +) Rubber eye brow rest to prevent scratching of eye-glasses illumination lens dial for clear identification of adopter setting.

Power Supply: 2 x C Batteries (not included in set).

Packing: Hard plastic case packing.



HP-178-026

Fiber Optic (ENT DIAGNOSTIC SET LARGE)

An ENT diagnostic set consists of different ENT tools that are used in the examination of the ears, nose and throat. Our Fiber Optic Diagnostic Set consists of following.

Handle for Otoscope and Ophthalmoscope with Bayonet Connection System.
2.5 V Led Otoscope Head.

1 Ophthalmoscope, 3 Reusable ear specula, 1 Curved Illuminator
2 Laryngeal Mirrors, 1 Tongue Depressor Support for disposable tongue depressor, 1 adjustable nasal speculum fitting., 20 pcs (2.5mm & 4.0mm, 10 each) of mini specula packed in transparent bottle. 2 spare LED bulb

Power Supply: 2 x C Batteries (not included in set).

Packing: Light weight zipper case.



HP-178-027

Conventional (ENT DIAGNOSTIC SET)

Handle for Otoscope and Ophthalmoscope with Bayonet Connection System.
2.5 V Led Otoscope Head.

1 Ophthalmoscope, 3 Reusable ear specula, 1 Curved Illuminator
2 Laryngeal Mirrors, 1 Tongue Depressor Support for disposable tongue depressor, 1 adjustable nasal speculum fitting., 2 spare LED bulb

Power Supply: 2 x C Batteries (not included in set).

Packing: Hard plastic case packing.



HP-179-028

(ENT DIAGNOSTIC SET LARGE)

Handle for Otoscope and Ophthalmoscope with Bayonet Connection System.
 2.5 V Led Otoscope Head.

1 Ophthalmoscope, 3 reusable ear specula, 1 Curved Illuminator
 2 Laryngeal Mirrors, 1 Tongue Depressor Support for disposable tongue depressor, 1 adjustable nasal speculum fitting., 2 spare LED bulb

Power Supply: 2 x C Batteries (not included in set).

Packing: Hard plastic case packing.



HP-179-029

(ENT DIAGNOSTIC SET)

Handle for Otoscope and Ophthalmoscope with screw locking System.
 2.5 V Led Otoscope Head.

1 Ophthalmoscope, 3 reusable ear specula, 1 Curved Illuminator
 2 Laryngeal Mirrors, 1 Tongue Depressor Support for disposable tongue depressor, 1 adjustable nasal speculum fitting., 2 spare LED bulb

Power Supply: 2 x C Batteries (not included in set).

Packing: Hard plastic case packing.



Trocars, Suction Tubes, Cannulas

Trokare, Saugrohre, Kanülen

Trocars, Tubos de Sucção, Cânulas

Trocares, tubos de succión, cánulas

Page 181-187

Trocars
Trokare
Trocars
Trocares

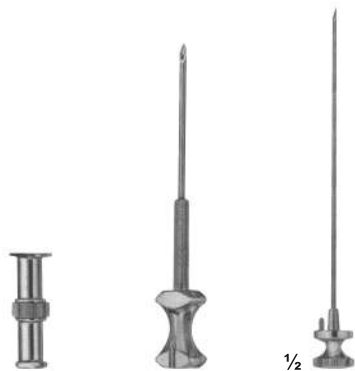

Klima Rosegger
HP-181-001
35 X 1.8 mm
Sternal puncture needle



Universal Trocar
HP-181-002
With 4 tips

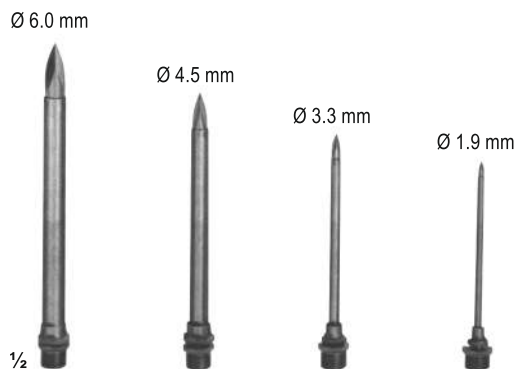

HP-181-003 - HP-181-007

	Inside dia.	Outside dia.
HP-181-003	2.2 mm	3 mm
HP-181-004	3 mm	4 mm
HP-181-005	4 mm	5 mm
HP-181-006	5 mm	6 mm
HP-181-007	5.5 mm	6.5 mm

For hydrocele and abdominal puncture



HP-181-008 - HP-181-011

	Inside dia.	Outside dia.
HP-181-008	2.2 mm	3 mm
HP-181-009	3 mm	4 mm
HP-181-010	4 mm	5 mm
HP-181-011	5 mm	6 mm

For abdominal puncture,
with stop-cock and lateral drain

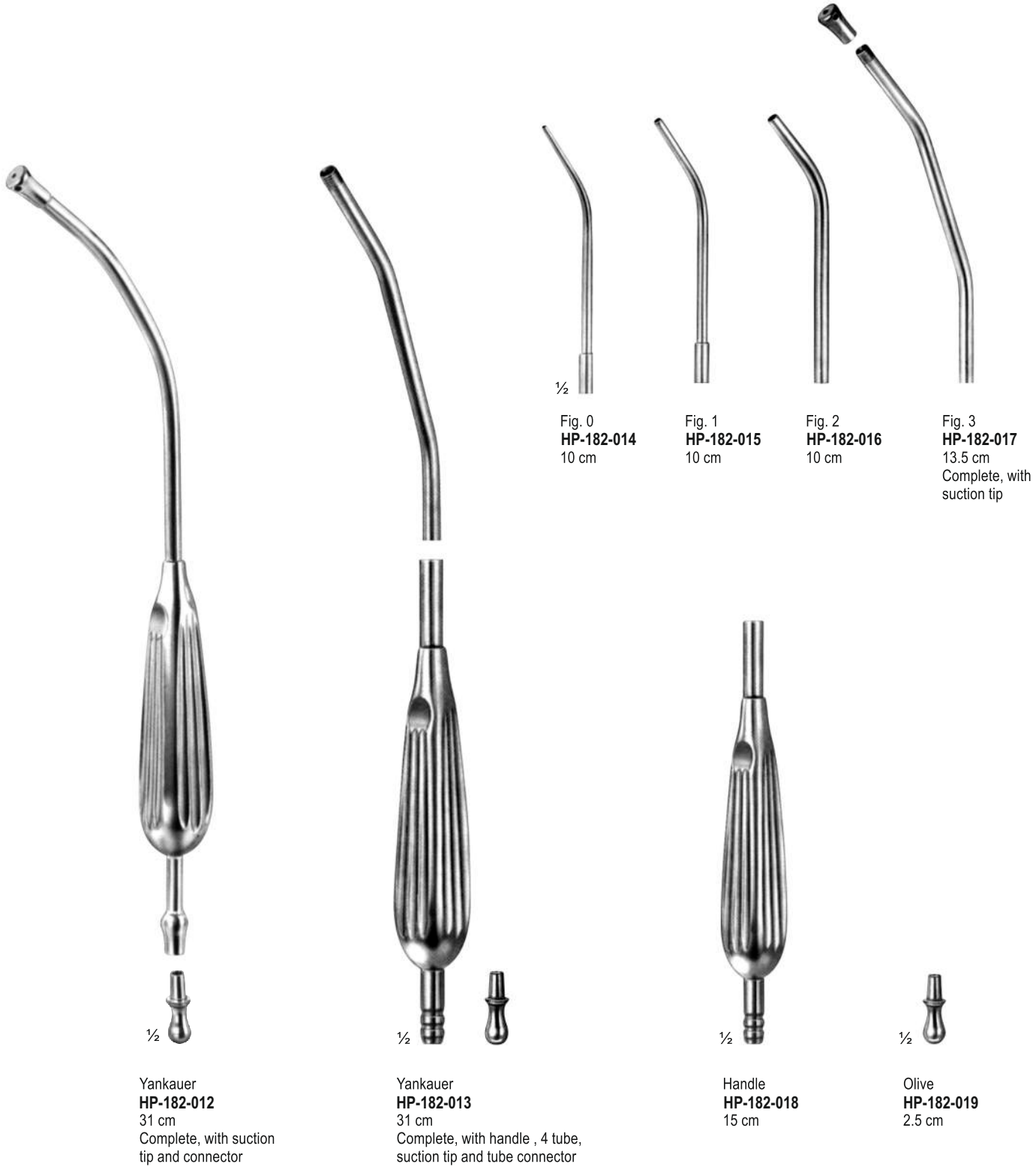

Suction tubes, Suction Instruments

Saugrohre, Sauginstrumente

Tubos de sucção, instrumentos de sucção

Tubos de succión, instrumentos de succión

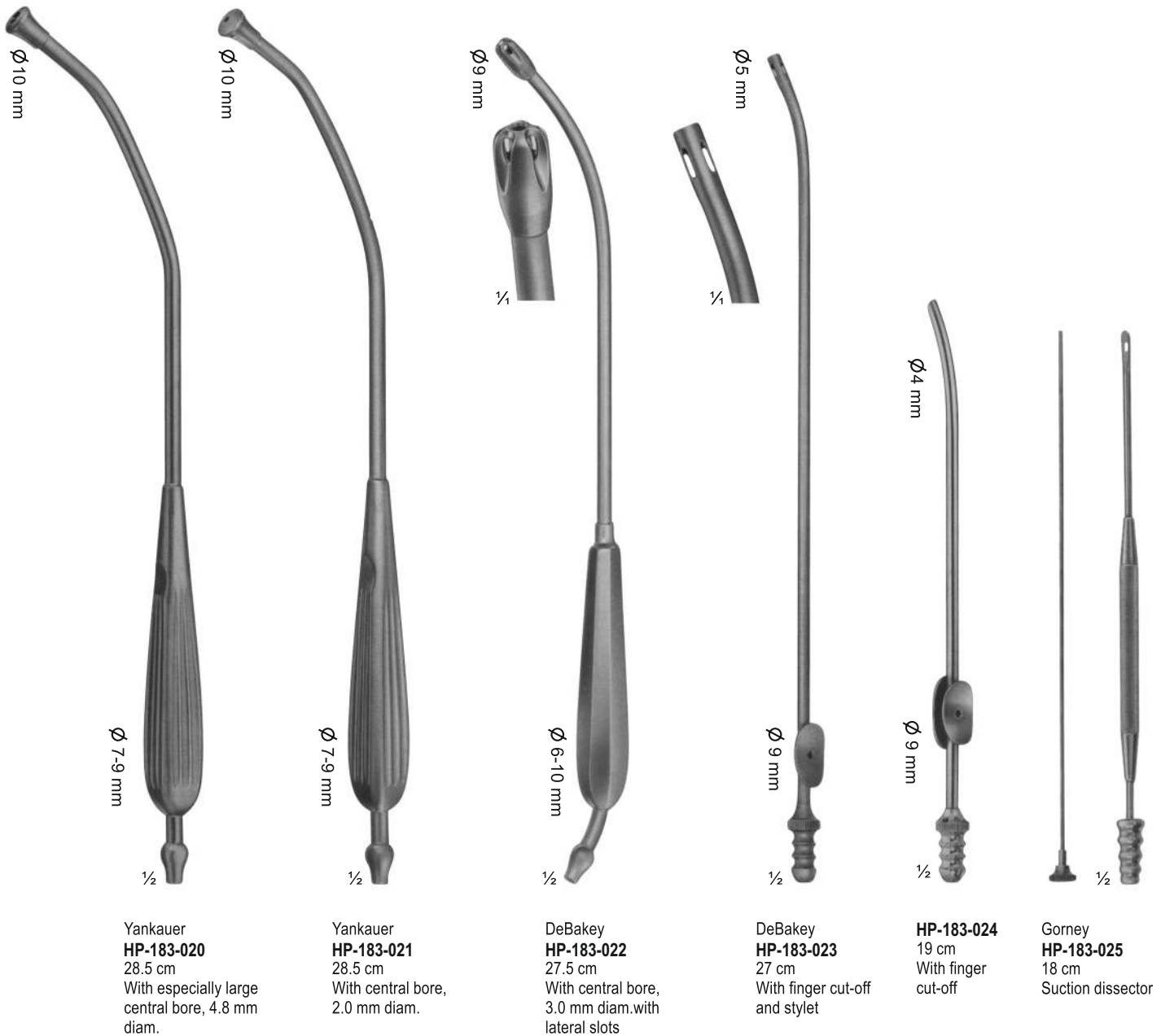

Yankauer
HP-183-020
28.5 cm
With especially large
central bore, 4.8 mm
diam.

Yankauer
HP-183-021
28.5 cm
With central bore,
2.0 mm diam.

DeBakey
HP-183-022
27.5 cm
With central bore,
3.0 mm diam.with
lateral slots

DeBakey
HP-183-023
27 cm
With finger cut-off
and stylet

HP-183-024
19 cm
With finger
cut-off

Gorney
HP-183-025
18 cm
Suction dissector

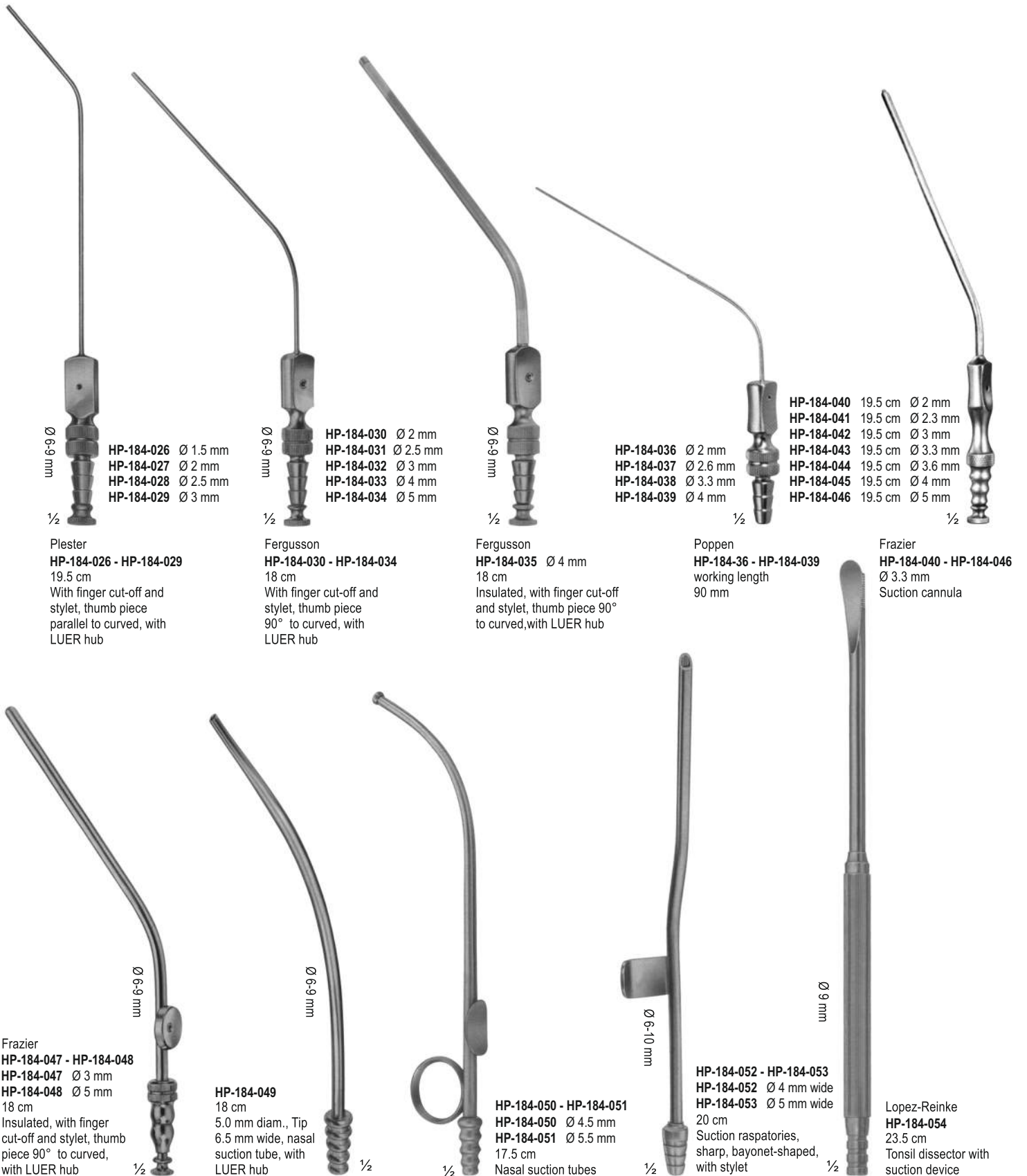

mm 6-9 Ø

HP-184-026 Ø 1.5 mm
HP-184-027 Ø 2 mm
HP-184-028 Ø 2.5 mm
HP-184-029 Ø 3 mm

1/2

Plester
HP-184-026 - HP-184-029
19.5 cm
With finger cut-off and stylet, thumb piece parallel to curved, with LUER hub

mm 6-9 Ø

HP-184-030 Ø 2 mm
HP-184-031 Ø 2.5 mm
HP-184-032 Ø 3 mm
HP-184-033 Ø 4 mm
HP-184-034 Ø 5 mm

1/2

Fergusson
HP-184-030 - HP-184-034
18 cm
With finger cut-off and stylet, thumb piece 90° to curved, with LUER hub

mm 6-9 Ø

HP-184-036 Ø 2 mm
HP-184-037 Ø 2.6 mm
HP-184-038 Ø 3.3 mm
HP-184-039 Ø 4 mm

1/2

Fergusson
HP-184-035 Ø 4 mm
18 cm
Insulated, with finger cut-off and stylet, thumb piece 90° to curved, with LUER hub

mm 6-9 Ø

HP-184-040 19.5 cm Ø 2 mm
HP-184-041 19.5 cm Ø 2.3 mm
HP-184-042 19.5 cm Ø 3 mm
HP-184-043 19.5 cm Ø 3.3 mm
HP-184-044 19.5 cm Ø 3.6 mm
HP-184-045 19.5 cm Ø 4 mm
HP-184-046 19.5 cm Ø 5 mm

1/2

Poppen
HP-184-36 - HP-184-039
working length 90 mm

mm 6-9 Ø

Frazier
HP-184-040 - HP-184-046
Ø 3.3 mm
Suction cannula

mm 6-9 Ø

Frazier
HP-184-047 - HP-184-048
HP-184-047 Ø 3 mm
HP-184-048 Ø 5 mm
18 cm
Insulated, with finger cut-off and stylet, thumb piece 90° to curved, with LUER hub

1/2

mm 6-9 Ø

HP-184-049
18 cm
5.0 mm diam., Tip 6.5 mm wide, nasal suction tube, with LUER hub

1/2

1/2

HP-184-050 - HP-184-051
HP-184-050 Ø 4.5 mm
HP-184-051 Ø 5.5 mm
17.5 cm
Nasal suction tubes

mm 6-10 Ø

HP-184-052 - HP-184-053
HP-184-052 Ø 4 mm wide
HP-184-053 Ø 5 mm wide
20 cm
Suction raspatories, sharp, bayonet-shaped, with stylet

1/2

mm 9 Ø

Lopez-Reinke
HP-184-054
23.5 cm
Tonsil dissector with suction device

Suction Tubes

Saugrohre
Tubos de sucção
Tubos de succión



HP-185-055
Working length 75 mm
Ø 1 mm

1/2

Baron-Schuknecht
HP-185-055 - HP-185-057
With finer cut-off

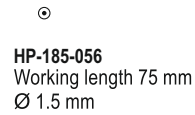

HP-185-056
Working length 75 mm
Ø 1.5 mm

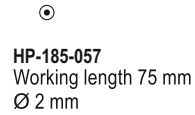

HP-185-057
Working length 75 mm
Ø 2 mm



Suction Tip

- HP-185-058 Ø 0.5 mm
- HP-185-059 Ø 0.7 mm
- HP-185-060 Ø 0.9 mm
- HP-185-061 Ø 1.2 mm

1/2

Zoellner
HP-185-056 - HP-185-061
Suction cannula



1/2

Wullstein
HP-185-062 - HP-185-064
14 cm
Handle with tube, only



Wullstein
HP-185-062
4.5 cm
Micro suction cannula
complete, with handle and 3 tips
Ø 0.4 mm



Wullstein
HP-185-063
4.5 cm
Micro suction cannula
complete, with handle and 3 tips
Ø 0.6 mm



Wullstein
HP-185-064
4.5 cm
Micro suction cannula
complete, with handle and 3 tips
Ø 0.8 mm

Combined Suction-Irrigation Cannula
 Kombinierte Saug-Spülkanüle
 Cãnula Combinada de Sucção-Irrigaçã
 Cãnula combinada de irrigación por succión

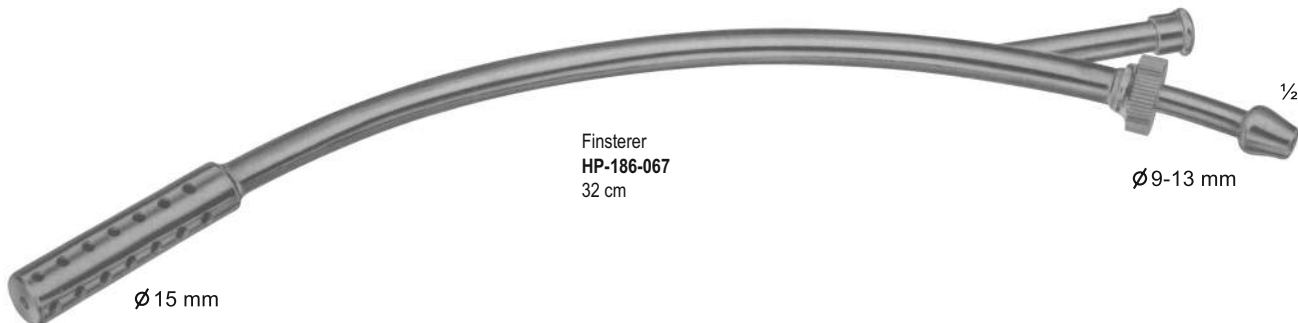
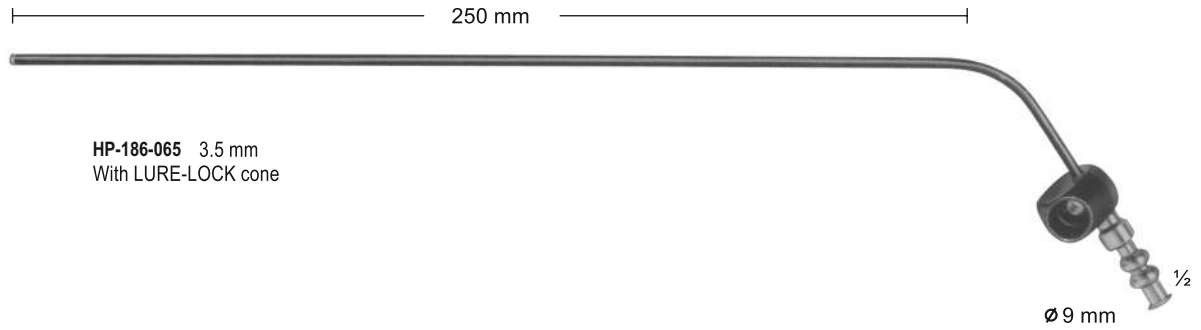

Suction Tube, Cannulas

Saugrohr, Kanülen
Tubo de Sucção, Cânulas
Tubo de succión, cânulas



Heparin

- HP-187-068 45 mm Ø 2 mm
 - HP-187-069 45 mm Ø 3 mm
 - HP-187-070 55 mm Ø 3.7 mm
 - HP-187-071 160 mm Ø 5 mm
- Flushing needle



Frazier

- HP-187-072 17 mm Ø 2 mm
 - HP-187-073 17 mm Ø 2.7 mm
 - HP-187-074 17 mm Ø 3.3 mm
 - HP-187-075 17 mm Ø 4 mm
- Suction tube



Frazier

- HP-187-076 17 mm Ø 2 mm
 - HP-187-077 17 mm Ø 2.7 mm
 - HP-187-078 17 mm Ø 3.3 mm
 - HP-187-079 17 mm Ø 4 mm
- Suction tube



Eisberg (Silver)

- HP-187-080 5 Fr. 13 cm
 - HP-187-081 7 Fr. 13 cm
 - HP-187-082 9 Fr. 13 cm
- Ventricular cannula



Jefferson

- HP-187-187
 - 100 mm
- Ventricular cannula

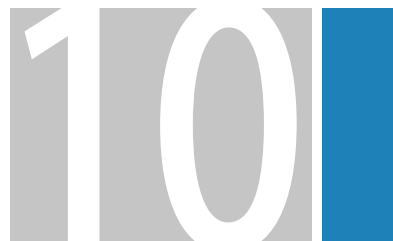

Anaesthesia

Anästhesie

Anestesia

Anestesia

Page 188-202

Flexible Tip Fiber Optic (F.O.) Laryngoscope

Flexible Spitze Fiber Optic (F. O.) Laryngoskop
Laringoscópio de Fibra Óptica com Ponta Flexível (F.O.)
Laringoscópio flexible de punta de fibra (F.O.)



3 mm FIBER OPTIC LIGHT



Fiber Optic Handle

**Flexible Tip Fiber Optic (F.O.) Laryngoscope Blade
FIBER OPTIC LIGHT**

This Flexible Tip Blade is a Macintosh Laryngoscope Blade with a tip which is adjustable through 90°. A lever controls the tip angle during intubation to lift the epiglottis, giving a clear view of the vocal cords. 5000 individual micro-fibers in 3 mm Fiber Optic tube improved light transmission and longer life.

- Outstanding light intensity with LED illumination through extra strong fiber bundle.
- Swiveling blade tip facilitates difficult intubation.
- Reduced likelihood of damage to teeth and soft tissues.
- Reduce the force required to visualize the Larynx.
- 303/304 type high grade Stainless Steel with Satin Finish.
- Fully autoclavable and easier to clean.
- Fiber Optic handle Requires 2 X C size batteries.
- According to ISO 7376 Standard.



Back view



Front view

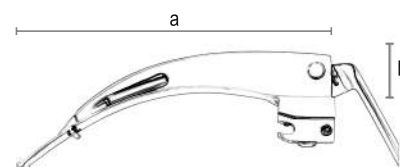

Flexible Tip Fiber Optic (F.O.) Laryngoscope Blade			
Size	Blade Reference no.	Length	
		a {mm}	b {mm}
1	HP-188-001	93	19
2	HP-188-002	112	19
3	HP-188-003	132	22
4	HP-188-004	155	24



Conventional Handle



LED LAMP

Flexible Tip Conventional Laryngoscope Blade
LED LAMP

The Flexible Tip is a Macintosh Laryngoscope Blade with a tip which is adjustable through 90°. A lever controls the tip angle during intubation to lift the epiglottis, giving a clear view of the vocal cords.

- Outstanding Light Intensity with LED Illumination.
- Swivelling blade tip facilitates difficult intubation.
- Reduced likelihood of damage to teeth and soft tissue.
- Rounded tip and smooth edges.
- 303/304 surgical stainless steel with satin finish.
- Fully autoclavable and easier to clean.
- Conventional handle Requires 2 X C size batteries.
- According to ISO 7376 Standard.



Back view

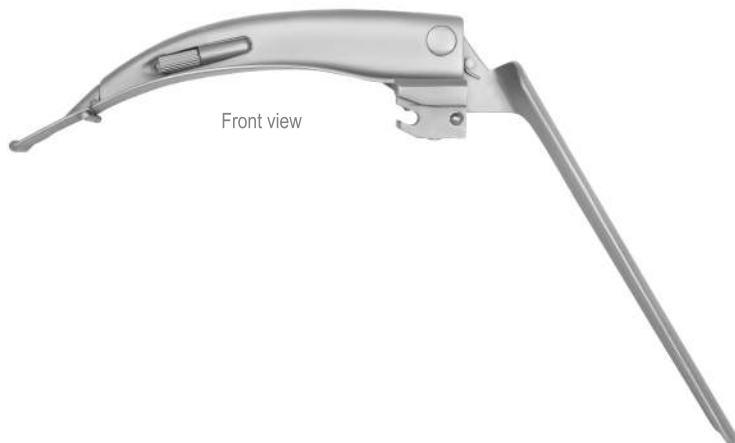

Front view

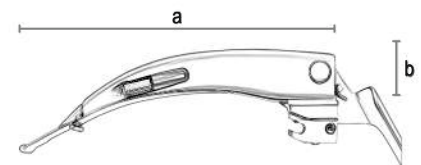

Flexible Tip Conventional Laryngoscope Blade			
Size	Blade Reference no.	Length	
		a {mm}	b {mm}
1	HP-189-005	93	19
2	HP-189-006	112	19
3	HP-189-007	132	22
4	HP-189-008	155	24

Macintosh, Mega Light, Fiber Optic (F.O.) Laryngoscope

Macintosh, Mega Light, faseroptisches (F.O.) Laryngoskop
Macintosh, Mega Light, laringoscópio de fibra óptica (F.O.)
Laringoscopia Macintosh, Mega Light, fibra óptica (F.O.)



Fiber Optic Handle

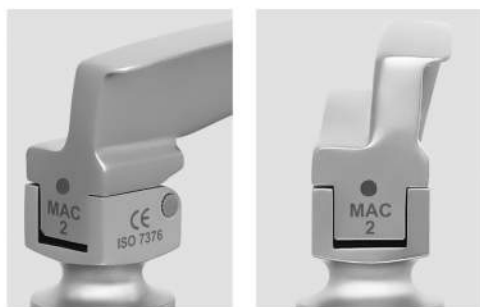
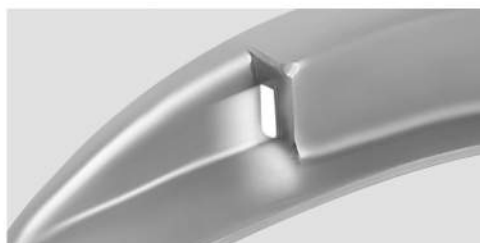

Fiber Optic (F.O.) Laryngoscope Blade
MEGA LIGHT

Macintosh Mega Light Laryngoscope blade with 4 x 6 mm and up to 6500 individual micro-fibers for improved light transmission and longer life.

- 303/304 type high grade Stainless Steel with Satin Finish.
- Smooth shape avoids sharp edges and cavities for easy cleaning and sterilizing.
- Integrated Fiber Optics for the best possible illumination.
- Compatible with all standard Fiber Optic handles.
- Fully autoclavable and easier to clean.
- Fiber Optic handle with LED light.
- According to ISO 7376 standard.

Power Source

- All our Fiber Optic handles are powered by
 - Standard battery handle: 2 "C" size
 - Pediatric battery handle: 2 "AA" size
 - Stubby battery handle: 2 "AA" size

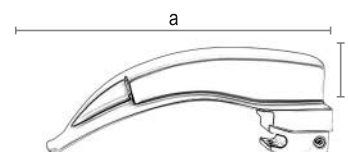

Fiber Optic (F.O.) Laryngoscope Blade. (Mega Blade)

Size	Blade	Length	
		a {mm}	b {mm}
1	HP-190-009	97	18
2	HP-190-010	114	18
3	HP-190-011	137	19
4	HP-190-012	157	22

Fiber Optic (F.O.) Laryngoscope Sets. (Mega Blade)

Reference no.	Description
HP-190-013	2 Blades + 1 Handle in Plastic Box.
HP-190-014	3 Blades + 1 Handle in Plastic Box.
HP-190-015	4 Blades + 1 Handle in Plastic Box.



Fiber Optic Handle



Fiber Optic (F.O.) Laryngoscope Blade

INTERCHANGEABLE LIGHT CONDUCTOR

Macintosh Fiber Optic laryngoscope blade with 4mm F.O light conductor, up to 6500 individual micro-fibers for improved light transmission and longer life.

- ✦ Blade with Removable light conductor which is simple to remove and refit without any tool.
- ✦ Integrated Fiber optic for the best Possible Illumination.
- ✦ 303/304 type high grade Stainless Steel with Satin Finish.
- ✦ Smooth shape avoids sharp edges.
- ✦ Fully autoclavable and easier to clean.
- ✦ Compatible with all Standard Fiber optic handles.
- ✦ Fiber optic Handle with LED light.
- ✦ According to ISO 7376 Standard.

Power Source

- ✦ All our Fiber Optic handles are powered by Standard battery handle: 2 " C " size
- ✦ Pediatric battery handle: 2 " AA " size
- ✦ Stubby battery handle: 2 " AA " size

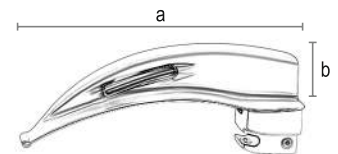

Macintosh Fiber Optic (F.O.) Laryngoscope Blades. (Interchangeable)

Size	Blade	Length	
		a {mm}	b {mm}
1	HP-191-016	102	18
2	HP-191-017	115	18
3	HP-191-018	137	21
4	HP-191-019	157	21

Macintosh Fiber Optic (F.O.) Laryngoscope Sets. (Interchangeable)

Reference no.	Description
HP-191-020	2 Blades + 1 Handle in Plastic Box.
HP-191-021	3 Blades + 1 Handle in Plastic Box.
HP-191-022	4 Blades + 1 Handle in Plastic Box.

Miller Fiber Optic (F.O.) Laryngoscope
Miller Fiber Optic (F.O.) Laryngoskop
Laringoscópio de fibra óptica Miller (F.O.)
Laringoscopio Miller Fiber Optic (F.O.)



Fiber Optic Handle

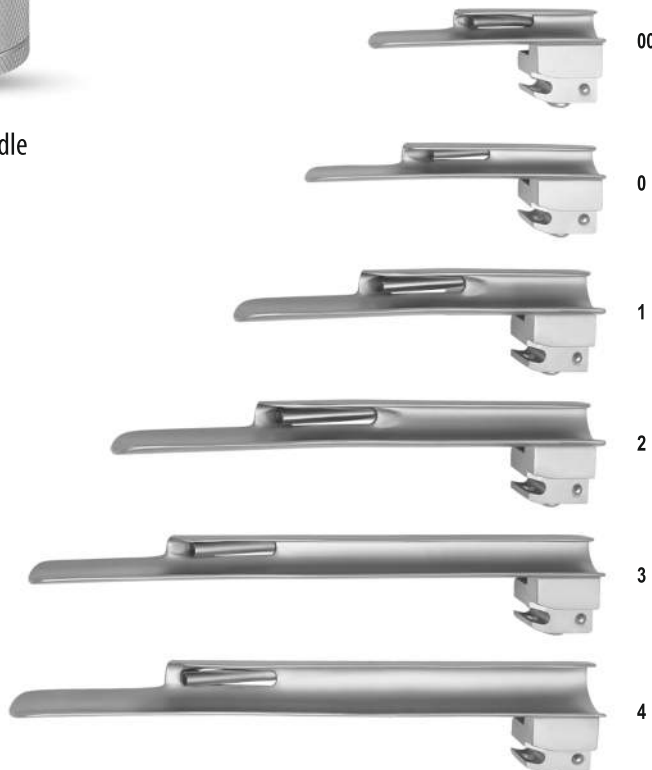

Fiber Optic (F.O.) Laryngoscope Blade INTERCHANGEABLE LIGHT CONDUCTOR

Miller Fiber Optic laryngoscope blade with 4mm F.O light conductor, up to 6500 individual micro-fibers for improved light transmission and longer life.

- Blade with Removable light conductor which is simple to remove and refit without any tool.
- Integrated Fiber optic for the best Possible Illumination.
- 303/304 type high grade Stainless Steel with Satin Finish.
- Smooth shape avoids sharp edges.
- Fully autoclavable and easier to clean.
- Compatible with all Standard Fiber optic handles.
- Fiber optic Handle with LED light.
- According to ISO 7376 Standard.

Power Source

- All our Fiber Optic handles are powered by
Standard battery handle: 2 " C " size
Pediatric battery handle: 2 " AA " size
Stubby battery handle: 2 " AA " size

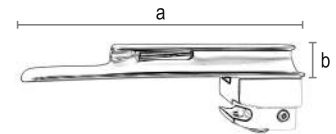

Miller Fiber Optic (F.O.) Laryngoscope Blades. (Interchangeable)

Size	Blade	Length	
		a {mm}	b {mm}
00	HP-192-023	70	12
0	HP-192-024	78	12
1	HP-192-025	105	12
2	HP-192-026	155	13
3	HP-192-027	195	13
4	HP-192-028	204	15

Miller Fiber Optic (F.O.) Laryngoscope Sets. (Interchangeable)

Reference no.	Description
HP-192-029	3 Blades + 1 Handle in Plastic Box.
HP-192-030	4 Blades + 1 Handle in Plastic Box.
HP-192-031	5 Blades + 1 Handle in Plastic Box.



Conventional Handle

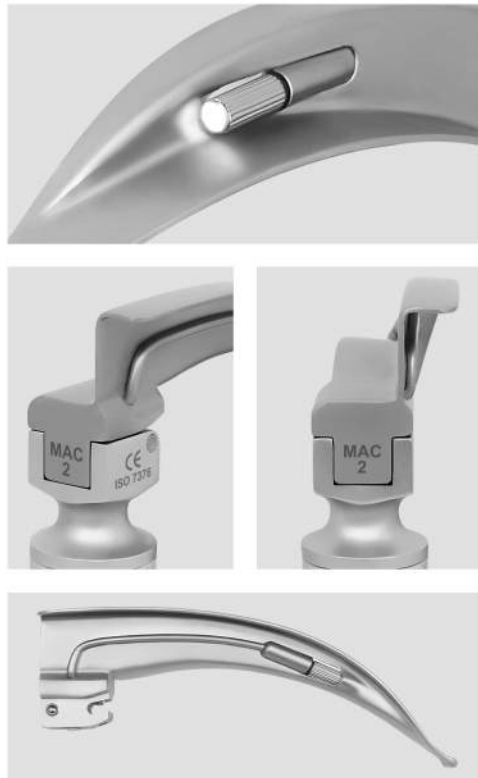

Conventional Laryngoscope Blade LED BULB

Macintosh Conventional Laryngoscope Blade with LED Bulb.
 The light bulb in the blade can easily be changed.

- Outstanding light intensity with LED illumination.
- 303/304 type high grade Stainless Steel.
- Satin finish laryngoscope blade reduces glare, ensures safer intubations
- Smooth knurled Handle provides grip without risk of tearing gloves.
- Fully autoclavable and easier to clean.
- According to ISO 7376 Standard.

Power Source

- All our Conventional handles are powered by
- Standard battery handle: 2 " C " size
- Pediatric battery handle: 2 " AA " size
- Stubby battery handle: 2 " AA " size

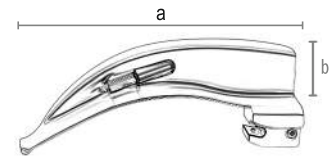

Macintosh Conventional Laryngoscope Blades.

Size	Blade Reference no.	Length	
		a {mm}	b {mm}
0	HP-193-032	82	17
1	HP-193-033	95	19
2	HP-193-034	114	19
3	HP-193-035	134	22
4	HP-193-036	157	24
5	HP-193-037	177	24

Macintosh Conventional Laryngoscope Sets.

Reference no.	Description
HP-193-038	3 Blades + 1 Handle in Plastic Box.
HP-193-039	4 Blades + 1 Handle in Plastic Box.
HP-193-040	5 Blades + 1 Handle in Plastic Box.

Miller Conventional Laryngoscope
Miller Herkömmliches Laryngoskop
Laringoscópio Convencional de Miller
Laringoscopia convencional Miller



Conventional Handle

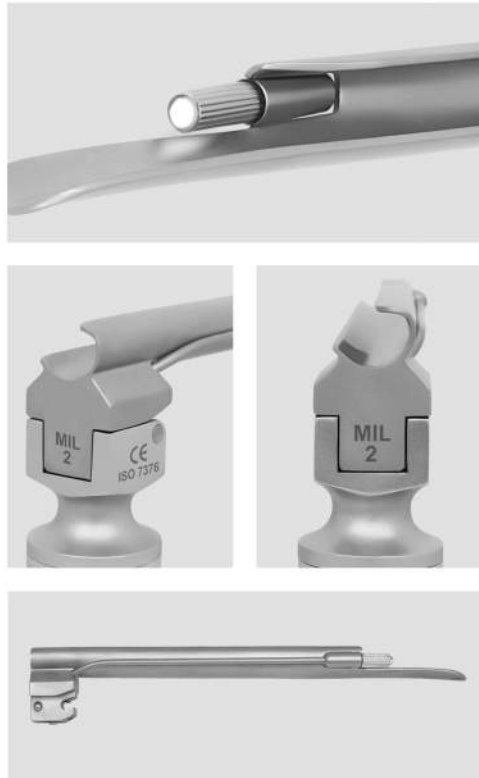

**Conventional Laryngoscope Blade
LED BULB**

Miller Conventional Laryngoscope Blade with LED Bulb.
The light bulb in the blade can easily be changed.

- Outstanding light intensity with LED illumination.
- 303/304 type high grade Stainless Steel.
- Satin finish laryngoscope blade reduces glare, ensures safer intubations
- Smooth knurled Handle provides grip without risk of tearing gloves.
- Fully autoclavable and easier to clean.
- According to ISO 7376 Standard.

Power Source

- All our Conventional handles are powered by
- Standard battery handle: 2 " C " size
- Pediatric battery handle: 2 " AA " size
- Stubby battery handle: 2 " AA " size

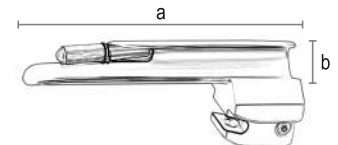
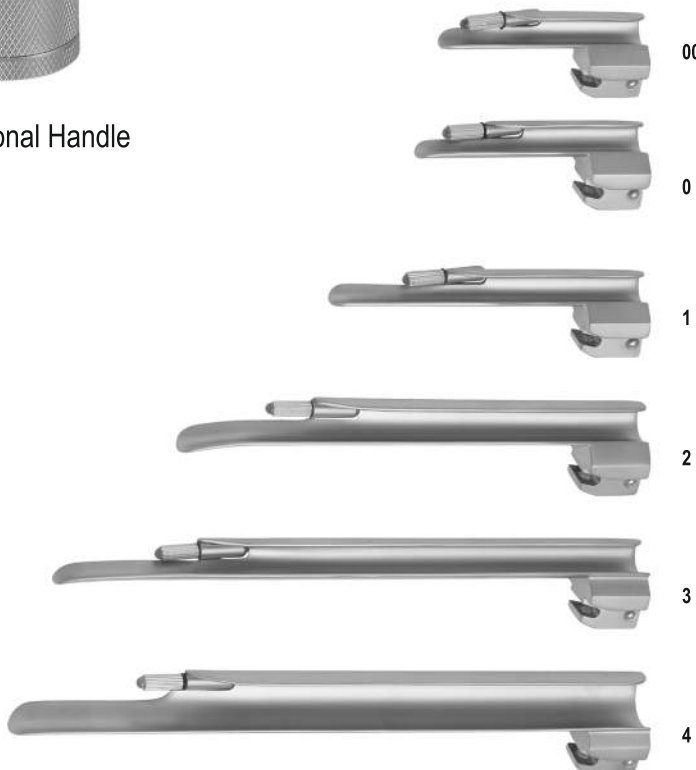

Miller Conventional Laryngoscope Blades.			
Size	Blade Reference no.	Length	
		a {mm}	b {mm}
00	HP-194-041	70	12
0	HP-194-042	78	12
1	HP-194-043	105	12
2	HP-194-044	155	13
3	HP-194-045	195	13
4	HP-194-046	204	15

Miller Conventional Laryngoscope Sets.	
Reference no.	Description
HP-194-047	3 Blades + 1 Handle in Plastic Box.
HP-194-048	4 Blades + 1 Handle in Plastic Box.
HP-194-049	5 Blades + 1 Handle in Plastic Box.

Macintosh Disposable Fiber Optic (F.O.) Laryngoscope
 Macintosh Einweg-Glasfaserkabel (F.O.) Laryngoskop
 Laringoscópio de Fibra Óptica Descartável Macintosh (F.O.)
 Laringoscópio de fibra óptica desechable Macintosh (F.O.)



Disposable
Fiber Optic Handle



Fiber Optic (F.O.) Laryngoscope Blade BLACK JACKET LIT LIGHT

Plastic Heel

Disposable Macintosh Laryngoscope blade with 4 mm plastic end lit Fiber Optic, it is processed from plastic Fiber Optic. We coat a plastic PVC jacket to protect inner fiber, working well keep it longer life and get more brightness black jacketed from Illuminator.

- Blade made of 304 type non-magnet stainless steel with plastic heel.
- Smooth shape avoids sharp edges and cavities.
- Integrated Fiber Optics for the best possible illumination.
- Compatible with all standard Fiber Optic handles.
- Disposable fiber Optic handle, made of silver, with LED light.
- According to ISO 7376 standard.

Power Source

- Watch-size lithium batteries are pre-installed for quick single use, and are easily removed for separate disposal. These Fiber Optic disposable handles will illuminate blades for up to 5 hours.

Available Colors: Blue, Yellow, Black, Green

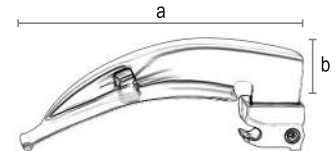

Macintosh Disposable Fiber Optic (F.O.) Laryngoscope Blade.

Size	Blade	Length	
	Reference no.	a {mm}	b {mm}
1	HP-195-050	102	18
2	HP-195-051	115	18
3	HP-195-052	137	21
4	HP-195-053	157	21

Macintosh Disposable Fiber Optic (F.O.) Laryngoscope Sets.

Reference no.	Description
HP-195-054	2 Blades + 1 Handle in Plastic Box.
HP-195-055	3 Blades + 1 Handle in Plastic Box.
HP-195-056	4 Blades + 1 Handle in Plastic Box.

Miller Disposable Fiber Optic (F.O.) Laryngoscope

Miller Einweg-Glasfaserkabel (F.O.) Laryngoskop
Laringoscópio de Fibra Óptica Descartável Miller (F.O.)
Laringoscopio Desechable de Fibra Óptica Miller (F.O.)



Disposable
Fiber Optic Handle

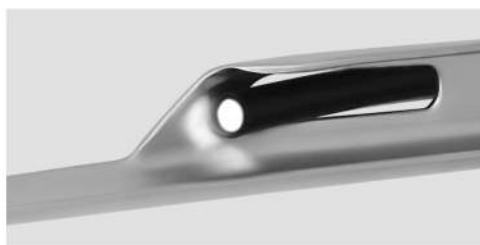

Fiber Optic (F.O.) Laryngoscope Blade
BLACK JACKET LIT LIGHT

Plastic Heel

Disposable Miller Laryngoscope blade with 4 mm plastic end lit Fiber Optic, it is processed from plastic Fiber Optic. We coat a plastic PVC jacket to protect inner fiber, working well keep it longer life and get more brightness black jacketed from Illuminator.

- Blade made of 304 type non-magnet stainless steel with plastic heel.
- Smooth shape avoids sharp edges and cavities.
- Integrated Fiber Optics for the best possible illumination.
- Compatible with all standard Fiber Optic handles.
- Disposable fiber Optic handle, made of silver, with LED light.
- According to ISO 7376 standard.

Power Source

- Watch-size lithium batteries are pre-installed for quick single use, and are easily removed for separate disposal. These Fiber Optic disposable handles will illuminate blades for up to 5 hours.

Available Colors: Blue, Yellow, Black, Green

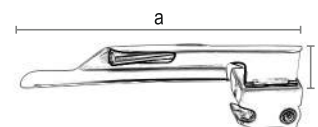

Miller Disposable Fiber Optic (F.O.) Laryngoscope Blade.

Size	Blade Reference no.	Length	
		a {mm}	b {mm}
00	HP-196-057	66	11
0	HP-196-058	76	11
1	HP-196-059	104	11
2	HP-196-060	155	14
3	HP-196-061	195	14
4	HP-196-062	205	14

Miller Disposable Fiber Optic (F.O.) Laryngoscope Sets.

Reference no.	Description
HP-196-063	3 Blades + 1 Handle in Plastic Box.
HP-196-064	4 Blades + 1 Handle in Plastic Box.
HP-196-065	5 Blades + 1 Handle in Plastic Box.



Disposable
Fiber Optic Handle



Disposable Fiber Optic (F.O.) Laryngoscope Blade
F.O ACRYLIC ROD

Silver Heel

Macintosh Single-Use Fiber Optic Blade with 5mm diameter acrylic rod for improved light transmission.

- :- Blade made of 304 type non-magnet stainless steel with silver heel.
- :- Smooth shape avoids sharp edges and cavities.
- :- Fiber Optic handle, made of silver, with LED light.
- :- Compatible with all standard Fiber Optic handles.
- :- According to ISO 7376 standard.

Power Source

- :- Watch-size lithium batteries are pre-installed for quick single use, and are easily removed for separate disposal. These Fiber Optic disposable handles will illuminate blades for up to 5 hours.

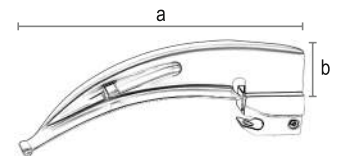

Macintosh Disposable Fiber Optic (F.O.) Laryngoscope Blade.

Size	Blade	Length	
		a {mm}	b {mm}
1	HP-197-066	102	18
2	HP-197-067	115	18
3	HP-197-068	137	21
4	HP-197-069	157	21

Macintosh Disposable Fiber Optic (F.O.) Laryngoscope Sets.

Reference no.	Description
HP-197-070	2 Blades + 1 Handle in Plastic Box.
HP-197-071	3 Blades + 1 Handle in Plastic Box.
HP-197-072	4 Blades + 1 Handle in Plastic Box.

Disposable Fiber Optic (F.O.) Laryngoscope

Einweg-Glasfaser (F.O.) Laryngoskop
fibra óptica descartável (F.O.) Laringoscópio
Laringoscopio desechable de fibra óptica (F.O.)



Disposable
Fiber Optic Handle

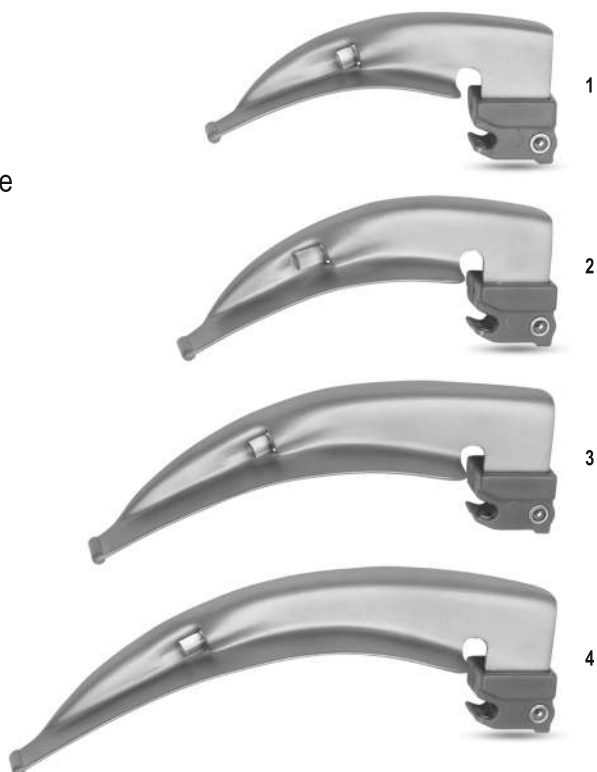
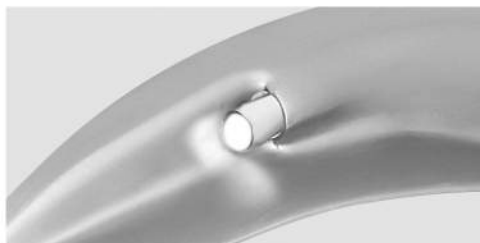

**Disposable Fiber Optic (F.O.) Laryngoscope Blade
F.O ACRYLIC ROD**

Plastic Heel

Macintosh Single-Use Fiber Optic Blade with 5mm diameter acrylic rod for improved light transmission.

- ⚡ Blade made of 304 type non-magnet stainless steel with plastic heel.
- ⚡ Smooth shape avoids sharp edges and cavities.
- ⚡ Fiber Optic handle, made of silver, with LED light.
- ⚡ Compatible with all standard Fiber Optic handles.
- ⚡ According to ISO 7376 standard.

Power Source

- ⚡ Watch-size lithium batteries are pre-installed for quick single use, and are easily removed for separate disposal. These Fiber Optic disposable handles will illuminate blades for up to 5 hours.

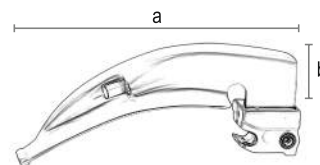

Macintosh Disposable Fiber Optic (F.O.) Laryngoscope Blade.

Size	Blade Reference no.	Length	
		a (mm)	b (mm)
1	HP-198-073	102	18
2	HP-198-074	115	18
3	HP-198-075	137	21
4	HP-198-076	157	21

Macintosh Disposable Fiber Optic (F.O.) Laryngoscope Sets.

Reference no.	Description
HP-198-077	2 Blades + 1 Handle in Plastic Box.
HP-198-078	3 Blades + 1 Handle in Plastic Box.
HP-198-079	4 Blades + 1 Handle in Plastic Box.



Fiber Optic (F.O.) Laryngoscope Handles

- Complies with ISO 7376 Green standard.
- Premium Handles & LED lamp have a lifetime warranty.
- Low power use prolongs battery life.
- Cool, white illumination improves view of larynx.
- Knurled Finish for secure & positive grip.
- Batteries not included.

Fiber Optic Laryngoscope Handles		
Reference no.	Size	Batteries
HP-199-080	Large	2 x " D "
HP-199-081	Medium/Standard	2 x " C "
HP-199-082	Small/Pen light	2 x " AA "
HP-199-083	Stubby	2 x " AA "
HP-199-084	Micro	Lithium 123

Conventional Laryngoscope Handles

Herkömmliche Laryngoskopgriffe
Pegas de laringoscópio convencionais
Mangos de laringoscópio convencionales



Conventional Laryngoscope Handles

- Complies with ISO 7376 Green standard.
- Premium Handles have a lifetime warranty.
- Low power use prolongs battery life.
- Cool, white illumination improves view of larynx.
- Knurled Finish for secure & positive grip.
- Batteries not included.

Conventional Laryngoscope Handles		
Reference no.	Size	Batteries
HP-200-085	Large	2 x " D "
HP-200-086	Medium/Standard	2 x " C "
HP-200-087	Small/Pen light	2 x " AA "
HP-200-088	Stubby	2 x " AA "
HP-200-089	Micro	Lithium 123

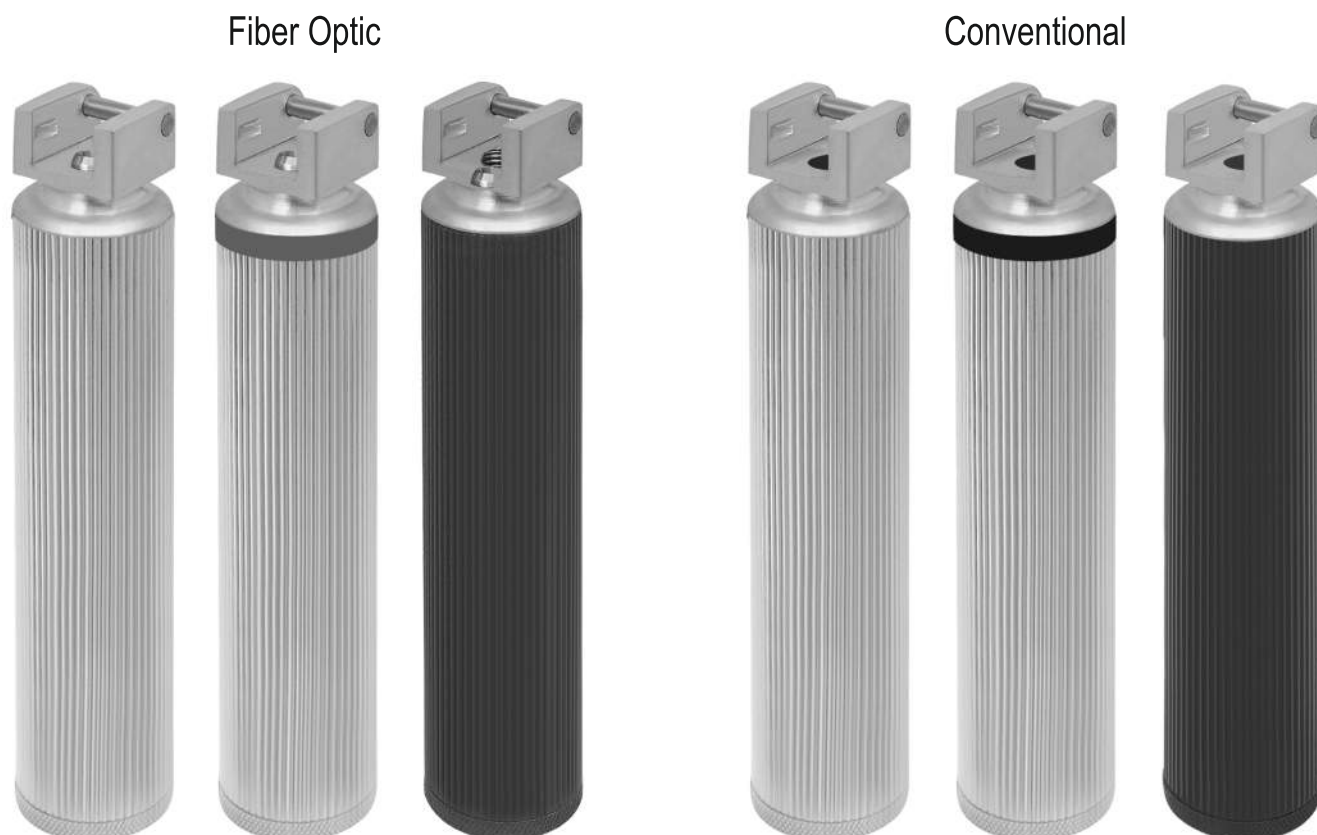

Disposable Fiber Optic (F.O.) Laryngoscope Handles

- :- Made of silver, available with & without powder coating.
- :- With LED bulb.
- :- Low power use prolongs battery life.
- :- Cool, white illumination improves view of larynx.
- :- Knurled Finish for secure & positive grip.
- :- Batteries not included.
- :- Complies with ISO 7376 Green standard.

Disposable Fiber Optic Laryngoscope Handles

Reference no.	Size	Batteries
HP-201-090	Standard	3 X Lithium " 123 "
HP-201-091	Standard	3 X Lithium " 123 "
HP-201-092	Standard	3 X Lithium " 123 "

Disposable Conventional Laryngoscope Handles

- :- Made of silver, available with & without powder coating.
- :- Low power use prolongs battery life.
- :- Knurled Finish for secure & positive grip.
- :- Batteries not included.
- :- Complies with ISO 7376 Green standard.

Disposable Conventional Laryngoscope Handles

Reference no.	Size	Batteries
HP-201-093	Standard	2 X Lithium " 123 "
HP-201-094	Standard	2 X Lithium " 123 "
HP-201-095	Standard	2 X Lithium " 123 "

Available Colors: Blue, Yellow, Black, Green

Catheter Introducing Forceps

Katheter, der Pinzetten vorstellt
Fórceps de introdução de cateter
Catéter que introduce fórceps



HP-202-096
15.5 cm
For babies



HP-202-097
15.5 cm
For children



HP-202-098
20 cm
For adults



Magil
HP-202-096 - HP-202-098

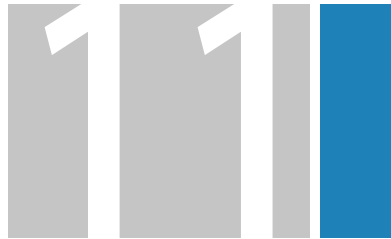

Suture

Naht
Sutura
Sutura

Page 203-227

Micro Needle Holders
Micro Nadelhalter
Suportes Micro Agulha
Micro Needle Holders



7-0 - 12-0



1/2

HP-203-001 - HP-203-004



15 cm	St	HP-203-001	HP-203-002	HP-203-003	HP-203-004
0.30 mm		With ratchet	With ratchet	W/o ratchet	W/o ratchet



7-0 - 12-0



1/2

Castroviejo
HP-203-005 - HP-203-008



15 cm	St	HP-203-005	HP-203-006	HP-203-007	HP-203-008
0.30 mm		With ratchet	With ratchet	W/o ratchet	W/o ratchet



7-0 - 12-0



1/2

Castroviejo
 HP-204-009 - HP-204-012



18 cm	St	HP-204-009	HP-204-010	HP-204-011	HP-204-012
0.40 mm		With ratchet	With ratchet	W/o ratchet	W/o ratchet



7-0 - 12-0



1/2

HP-204-013 - HP-204-028



15 cm	St	HP-204-013	HP-204-014	HP-204-015	HP-204-016
15 cm	Ti	HP-204-017	HP-204-018	HP-204-019	HP-204-020
18 cm	St	HP-204-021	HP-204-022	HP-204-023	HP-204-024
18 cm	Ti	HP-204-025	HP-204-026	HP-204-027	HP-204-028
0.40 mm		With ratchet	With ratchet	W/o ratchet	W/o ratchet

Micro Needle Holders
Micro Nadelhalter
Suportes Micro Agulha
Micro Needle Holders



7-0 - 12-0



1/2

HP-205-029 - HP-205-056

15 cm	St	HP-205-029	HP-205-030	HP-205-031	HP-205-032
15 cm	Ti	HP-205-033	HP-205-034	HP-205-035	HP-205-036
18 cm	St	HP-205-037	HP-205-038	HP-205-039	HP-205-040
18 cm	Ti	HP-205-041	HP-205-042	HP-205-043	HP-205-044
21 cm	St	HP-205-045	HP-205-046	HP-205-047	HP-205-048
21 cm	Ti	HP-205-049	HP-205-050	HP-205-051	HP-205-052
23 cm	St	HP-205-053	HP-205-054	HP-205-055	HP-205-056
Ø 0.80 mm		With ratchet	With ratchet	W/o ratchet	W/o ratchet



Kalt
HP-205-057
13.5 cm



Barraquer-Troutman
HP-205-058 - HP-205-059
10.5 cm

HP-205-058
10.5 cm

HP-205-059
10.5 cm



Arruga
HP-205-060 - HP-205-061

HP-205-060
13.5 cm

HP-205-061
13.5 cm



1/2

Barraquer-Troutman
 HP-206-062 - HP-206-065



HP-206-062	HP-206-063	HP-206-064	HP-206-065
10.5 cm	11.5 cm	10.5 cm	11.5 cm



1/2

Barraquer
 HP-206-066 - HP-206-070



HP-206-066	HP-206-067	HP-206-068	HP-206-069	HP-206-070
11.5 cm	11.5 cm	13.5 cm	14 cm	14 cm
W/o ratchet	W/o ratchet	W/o ratchet	With ratchet	W/o ratchet

Micro Needle Holders

Micro Nadelhalter
Suportes Micro Agulha
Micro Needle Holders



Barraquer
HP-207-071
13.5 cm



Castroviejo-Fine
HP-207-072
13 cm



Castroviejo-Fine
HP-207-073
13 cm
Very delicate jaw, with lock



Castroviejo-Fine
HP-207-074
13 cm
Very delicate jaw, with lock



Castroviejo
HP-207-075 -HP-207-076
with lock

HP-207-075
14.5 cm

HP-207-076
14.5 cm



Castroviejo
HP-207-077 -HP-207-078

HP-207-077
14.5 cm

HP-207-078
14.5 cm

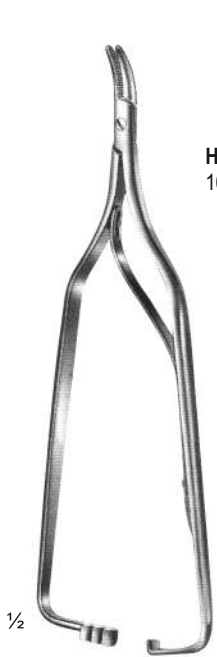

HP-208-079
16 cm



HP-208-080
16 cm

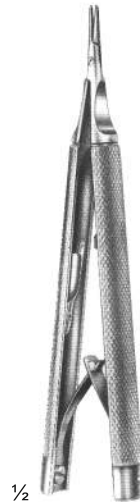

HP-208-081



HP-208-082

Arruga
HP-208-079 -HP-208-080
 Needle holder

Castroviejo
HP-208-081
 12 cm
 with lock

Castroviejo
HP-208-082
 12 cm
 with lock



HP-208-083
14.5 cm



HP-208-084
14.5 cm



Castroviejo
HP-208-085
 14.5 cm

Castroviejo
HP-208-083 - HP-208-084
 with lock

Needle Holders

Nadelhalter
Suportes de Agulhas
Portaagujas

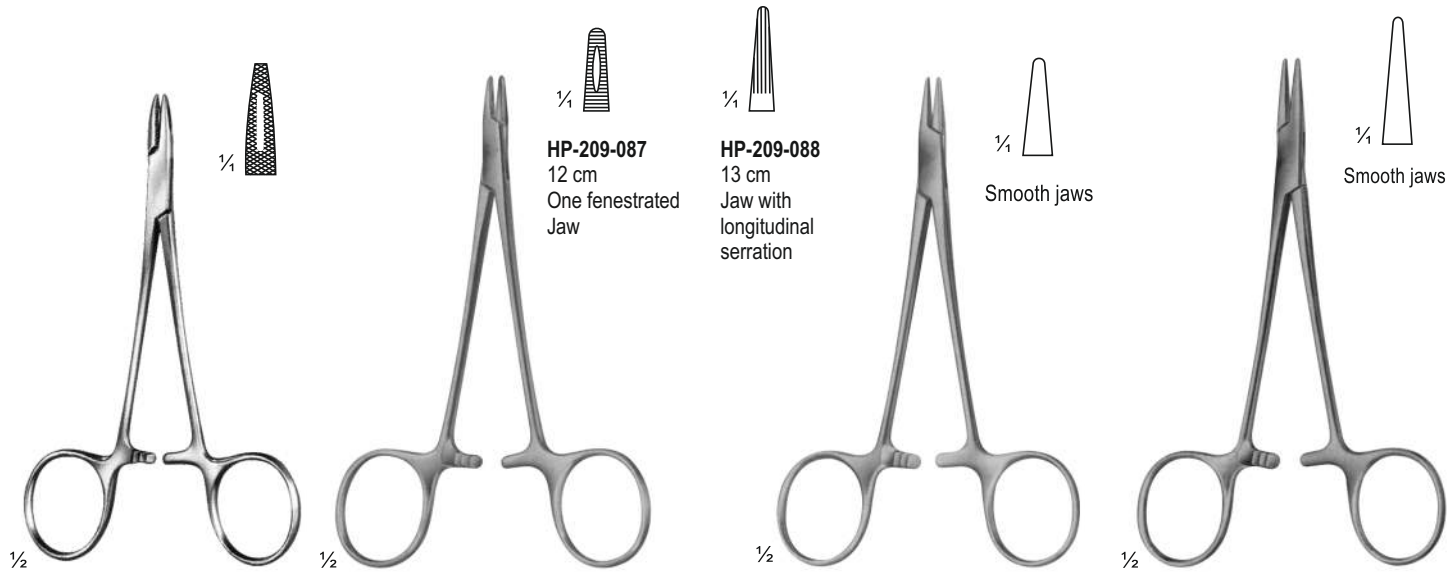

Collier
HP-209-086
12.5 cm
Both jaws fenestrated throughout

Derf
HP-209-087 - HP-209-088
13 cm
One fenestrated Jaw

Webster
HP-209-089
13 cm
Jaw with longitudinal serration

Halsey
HP-209-090
13.5 cm
Smooth jaws

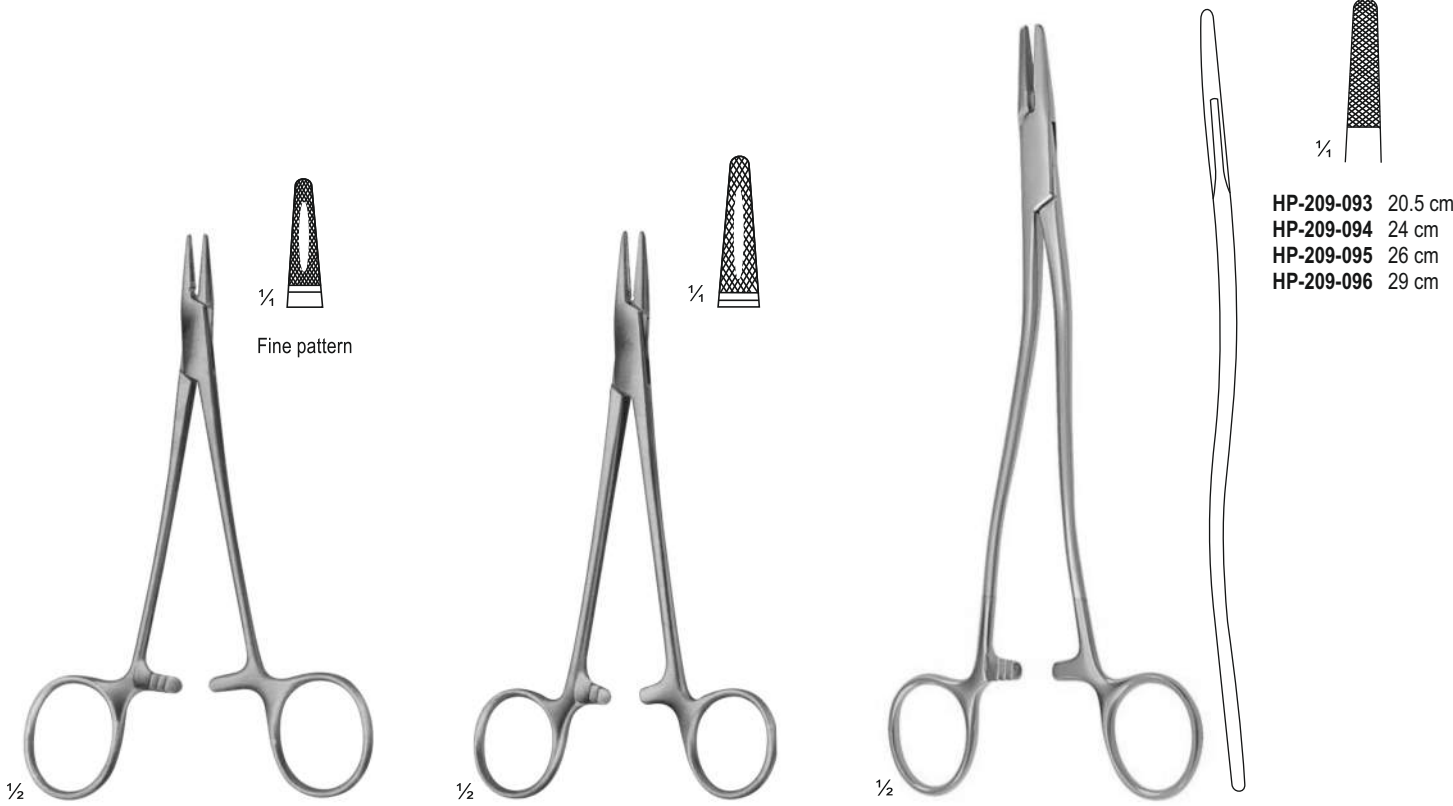

Crile-Wood
HP-209-091
15 cm
Fine pattern

Crile-Wood
HP-209-092
15 cm

Bozemann
HP-209-093 - HP-209-096
20.5 cm
Standard profile

- HP-209-093** 20.5 cm
- HP-209-094** 24 cm
- HP-209-095** 26 cm
- HP-209-096** 29 cm

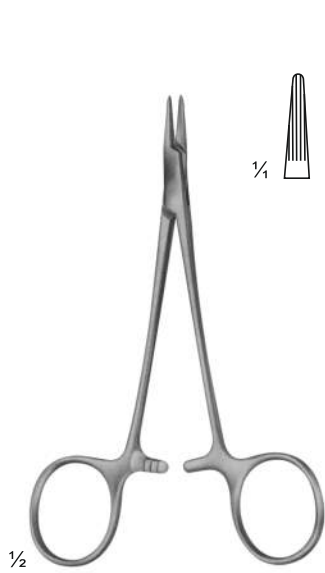

Converse
HP-210-097
12.5 cm



Hegar-Baumgartner
HP-210-098
14 cm



Crile-Murray
HP-210-099
15 cm
Slender pattern

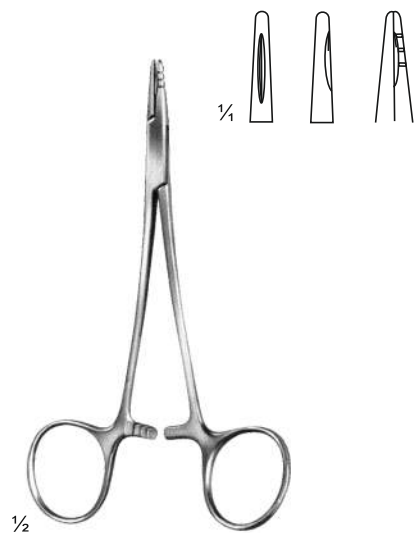

Neivert
HP-210-100
12.5 cm
Smooth jaw, special groove

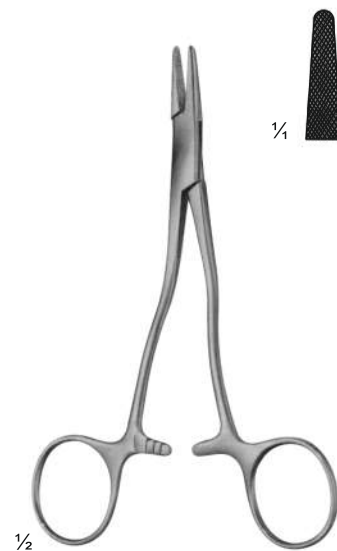

Kilner
HP-210-101
13.5 cm



Adson
HP-210-102
18.5 cm
One fenestrated jaw



HP-211-103 13 cm
HP-211-104 18 cm
Diagonally serrated jaw

Brown
HP-211-103 - HP-211-104
Heavy Pattern

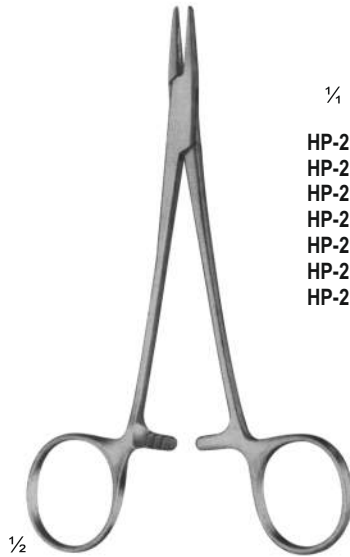

HP-211-105 14 cm
HP-211-106 16 cm
HP-211-107 18 cm
HP-211-108 20 cm
HP-211-109 24 cm
HP-211-110 26 cm
HP-211-111 30 cm

Mayo-Hegar
HP-211-105 - HP-211-111

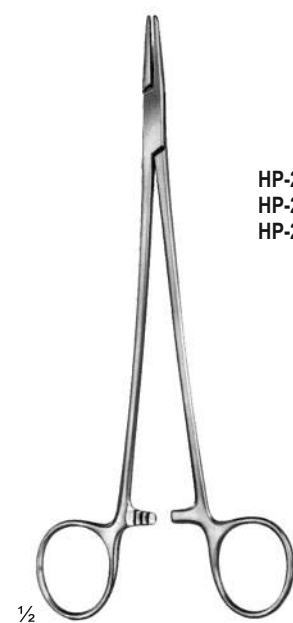

HP-211-112 16 cm
HP-211-113 19 cm
HP-211-114 20.5 cm

Mayo-Hegar
HP-211-112 - HP-211-114
16 cm
Slender patterns



M. G. Hospital
HP-211-115
18 cm
Heavy patterns



Metzenbaum
HP-211-116
18.5 cm
One grooved and fenestrated jaw



Heaney
HP-211-117
20.5 cm



1/2

Jameson
HP-212-118
23 cm



1/2

Wangensteen
HP-212-119
26.5 cm



1/2

Masson
HP-212-120
26.5 cm
Heavy patterns

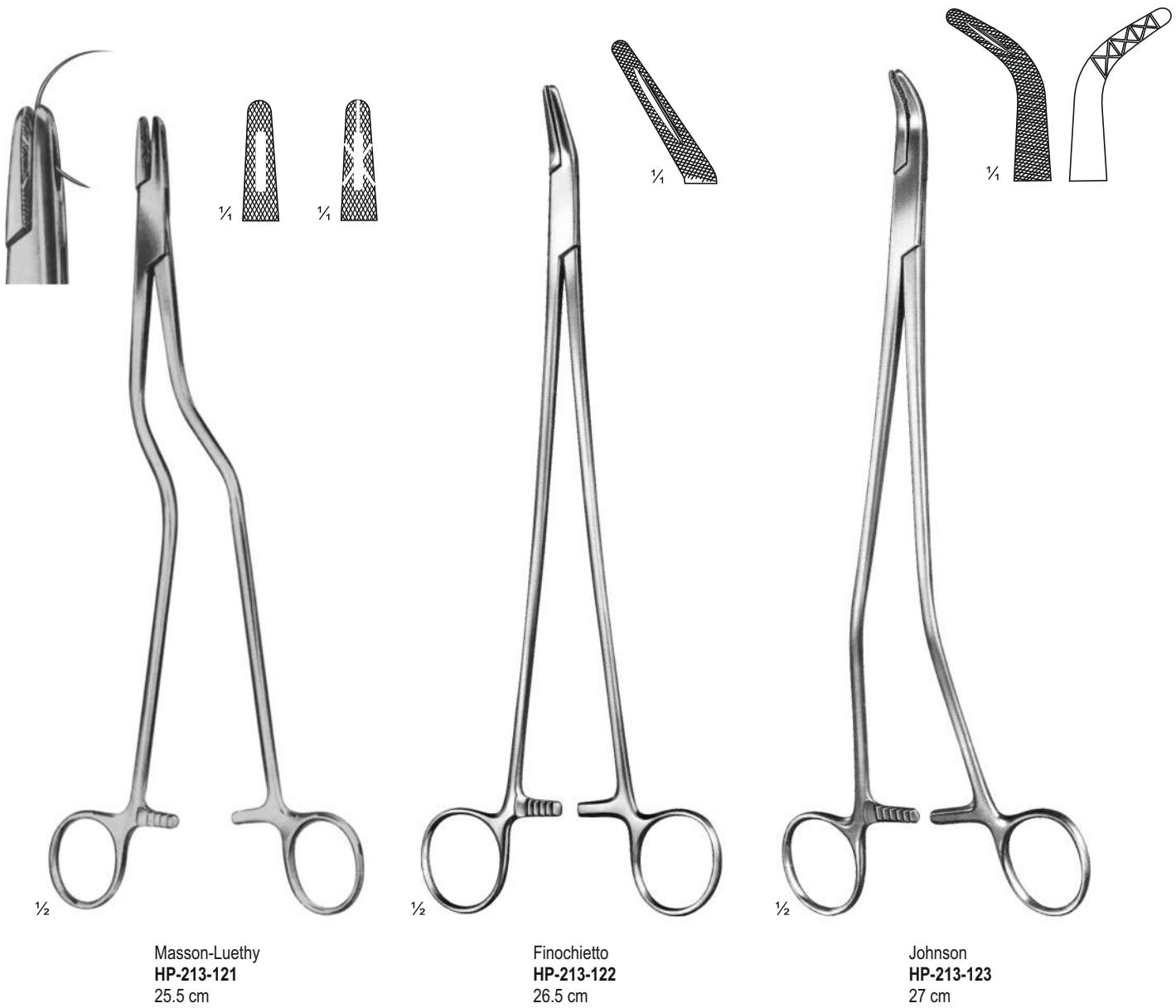

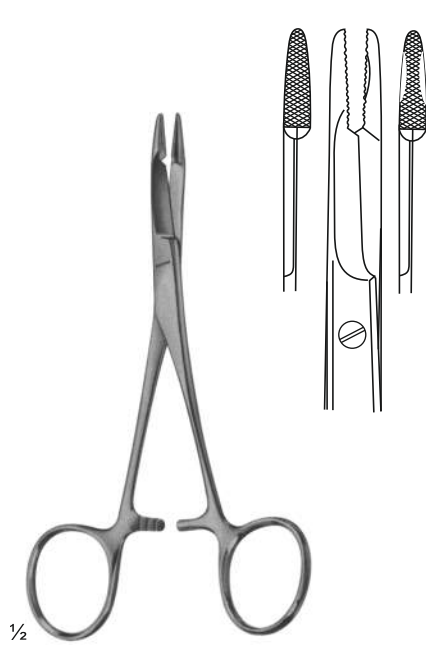

Olsen-Hegar
HP-214-124
14 cm

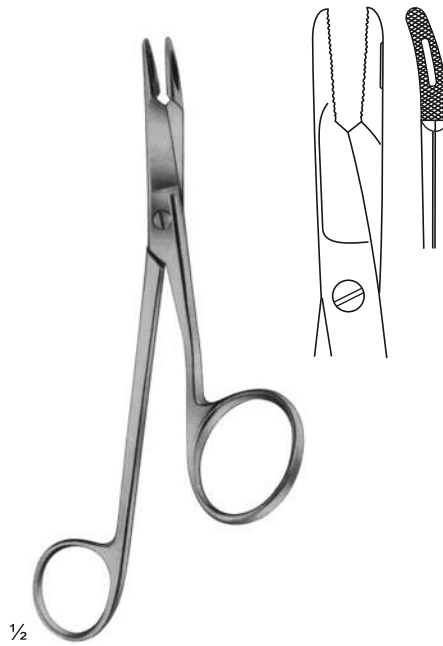

Gillies
HP-214-125
16 cm

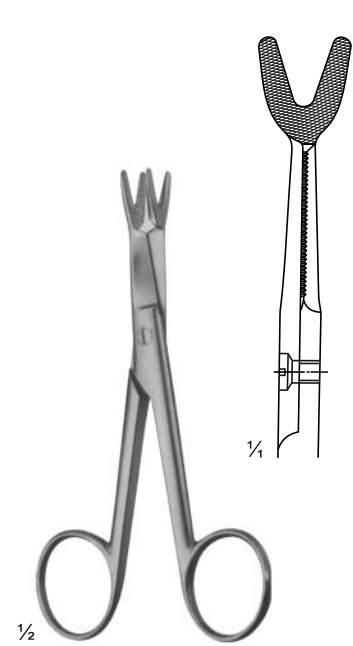

Schoemaker-Loth
HP-214-126
12.5 cm

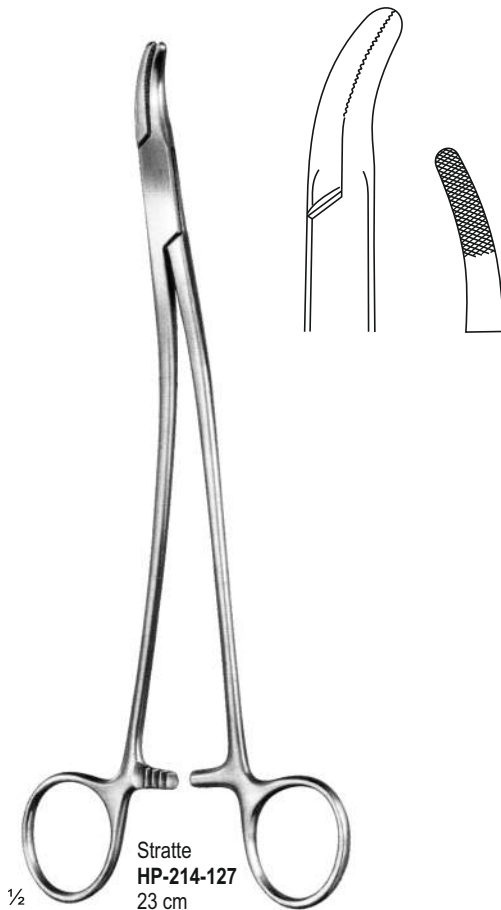

Stratte
HP-214-127
23 cm



Toennis
HP-214-128
18.5 cm



Crile
HP-214-129
15 cm

Needle Holders

Nadelhalter
Suportes de Agulhas
Portaagujas

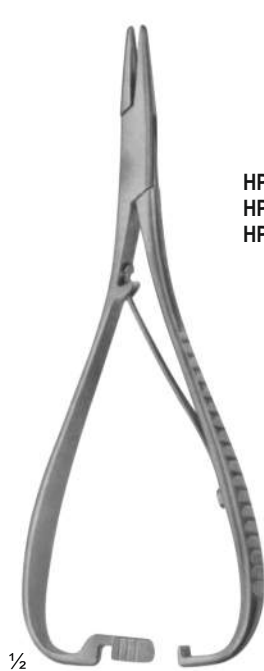

Mathieu
HP-215-130 - HP-215-132
17 cm



HP-215-130 14 cm
HP-215-131 17 cm
HP-215-132 20 cm



Mathieu-Style
HP-215-133 - HP-215-134
17 cm
Slender pattern



HP-215-133 14 cm
HP-215-134 17 cm



Boynton
HP-215-135
12.5 cm



Eiselsberg-Mathieu
HP-215-136
19.5 cm
For palate suture

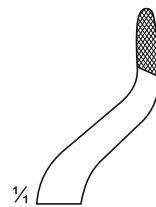

Lichtenberg
HP-215-137
20 cm





Micro Needle Holders, Needle Holders

Micro Nadelhalter, Nadelhalter
 Micro porta-agulhas, porta-agulhas
 Micro Needle Holders, Needle Holders



<p>1/2</p>	<p>HP-216-140 23 cm</p> <p>HP-216-141 23 cm</p> <p>HP-216-142 19 cm</p> <p>1/2</p>	<p>HP-216-143 21 cm</p> <p>HP-216-144 23 cm</p> <p>1/2</p>	<p>HP-216-145 20 cm</p> <p>HP-216-146 22 cm</p> <p>HP-216-147 16.5 cm</p> <p>HP-216-148 20 cm</p> <p>HP-216-149 22 cm</p> <p>HP-216-150 24.5 cm</p>
<p>Lichtenberg HP-216-138 16 cm Smooth jaw</p>	<p>HP-216-140 - HP-216-142 Smooth jaw</p>	<p>Rhoton-Type HP-216-143 - HP-216-144 Needle holder</p>	<p>HP-216-145 - HP-216-150</p>

TC GOLD

1/2

6-0 - 12-0

Hepp-Scheidel
HP-216-151
 18.5 cm
 Smooth jaw

1/2

Webster
HP-216-152
 13 cm
 Mini profile
 with automatic release
 ratchet also for lefthanders

Crile-Wood
HP-216-153
 15 cm

4-0 - 6-0

HP-216-152 - HP-216-153
 Needle Holder

Micro Needle Holders

Micro Nadelhalter
Suportes Micro Agulha
Micro Needle Holders



HP-217-154
14.5 cm
Micro profile



HP-217-155
18 cm
Micro profile



HP-217-156
22 cm
Micro profile



HP-217-157
14.5 cm
Smooth jaw



1/2

Castroviejo
HP-217-154 - HP-217-161



HP-217-158
14.5 cm
Micro profile



HP-217-159
18 cm
Micro profile



HP-217-160
22 cm
Micro profile



HP-217-161
14.5 cm
Smooth jaw



1/2

Arruga
HP-217-162 - HP-217-163
16 cm



HP-217-162
Mini profile



HP-217-163
Mini profile





Castroviejo
HP-218-164
 12 cm
 Micro needle holder
 with lock, smooth jaw

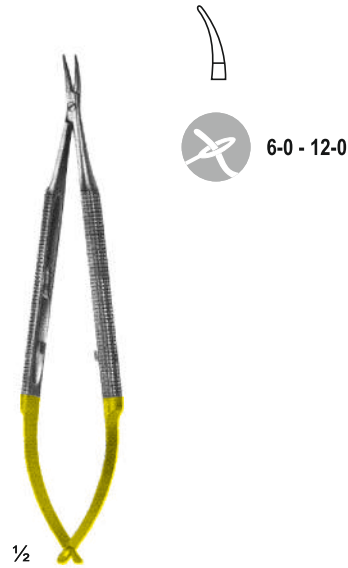

Barraquer
HP-218-165
 13 cm
 Micro needle holder
 with lock, smooth jaw



Barraquer
HP-218-166
 13 cm
 Micro needle holder
 smooth jaw

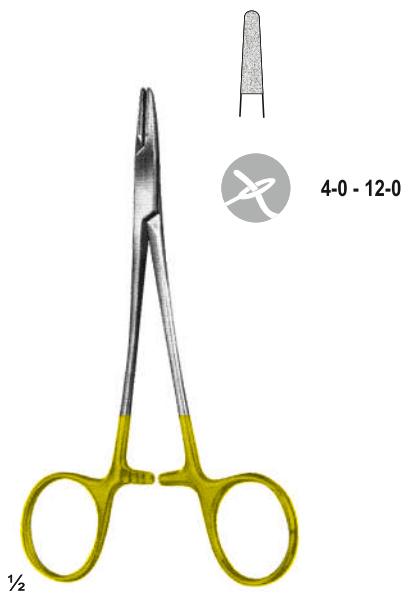

Webster
HP-218-167
 13 cm
 Smooth jaw



Kilner
HP-218-168
 14.5 cm
 Mini profile



Derf
HP-218-169
 12 cm
 Mini profile

Micro Needle Holders T.C.
Mikro-Nadelhalter T.C.
Suportes de Micro Agulhas T.C.
Micro Needle Holders T.C.



1/2
Kalt
HP-219-170
13.5 cm



1/2
Diethrich Ryder
SU-296-171 - SU-296-175
SU-296-171 16 cm
SU-296-172 18 cm
SU-296-173 20 cm
SU-296-174 23 cm
SU-296-175 26 cm

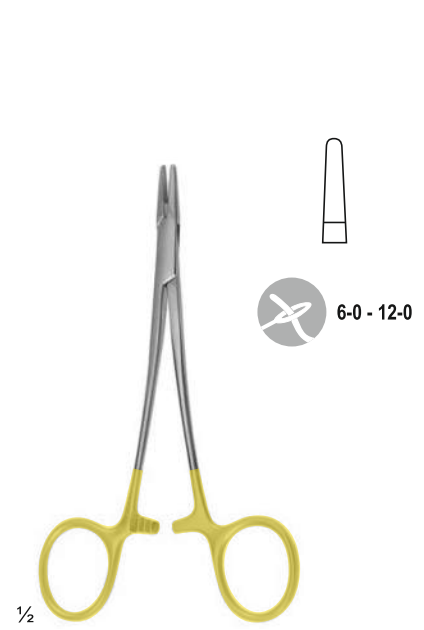

1/2
Webster
SU-296-176
12 cm
Smooth jaw



1/2
Hegar-Baumgartner
SU-296-177 - SU-296-178
14.5 cm
Mini profile



SU-296-178
14.5 cm



1/2
Halsey
SU-296-179 - SU-296-180
13 cm

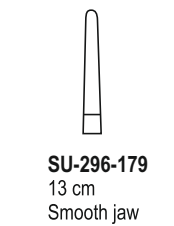

SU-296-179
13 cm
Smooth jaw

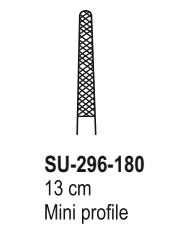

SU-296-180
13 cm
Mini profile

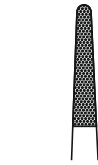

- HP-220-181 18 cm
- HP-220-182 20 cm
- HP-220-183 23 cm
- HP-220-184 26 cm
- HP-220-185 31 cm



DeBakey
HP-220-181 - HP-220-185
18 cm
Slender pattern, mini profile



- HP-220-186 15 cm
- HP-220-187 20 cm



Crile-Wood
HP-220-186 - HP-220-187
15 cm
Mini profile



- HP-220-188 18 cm
- HP-220-189 20 cm
- HP-220-190 26 cm



Sarot
HP-220-188 - HP-220-190
18 cm
Standard profile



- HP-220-191 16 cm
- HP-220-192 18.5 cm
- HP-220-193 20 cm
- HP-220-194 24 cm
- HP-220-195 26 cm
- HP-220-196 30 cm



Mayo-Hegar
HP-220-191 - HP-220-196
18 cm
Standard profile



- HP-220-197 20.5 cm
- HP-220-198 24 cm
- HP-220-199 26.5 cm



Heaney
HP-220-197 - HP-220-199
20.5 cm
Standard profile

Needle Holders T.C.
Nadelhalter T.C.
Suportes de Agulhas T.C.
Needle Holders T.C.



HP-221-200 14 cm
HP-221-201 18 cm
HP-221-202 20 cm
HP-221-203 23 cm



HP-221-204 20 cm
HP-221-205 24 cm
HP-221-206 26 cm



Mayo-Hegar (Heaney)
HP-221-200 - HP-221-203
23 cm

Mayo-Hegar (Heaney)
HP-221-204 - HP-221-206
26 cm

Masson
HP-221-207
26.5 cm
Standard profile



- HP-222-208 13 cm
- HP-222-209 15 cm
- HP-222-210 18 cm
- HP-222-211 20 cm
- HP-222-212 23 cm
- HP-222-213 26 cm



Ryder
HP-222-208 - HP-222-213
23 cm
Standard profile



- HP-222-214 10 cm
- HP-222-215 15.5 cm
- HP-222-216 17.5 cm
- HP-222-217 20 cm
- HP-222-218 22.5 cm
- HP-222-219 26 cm

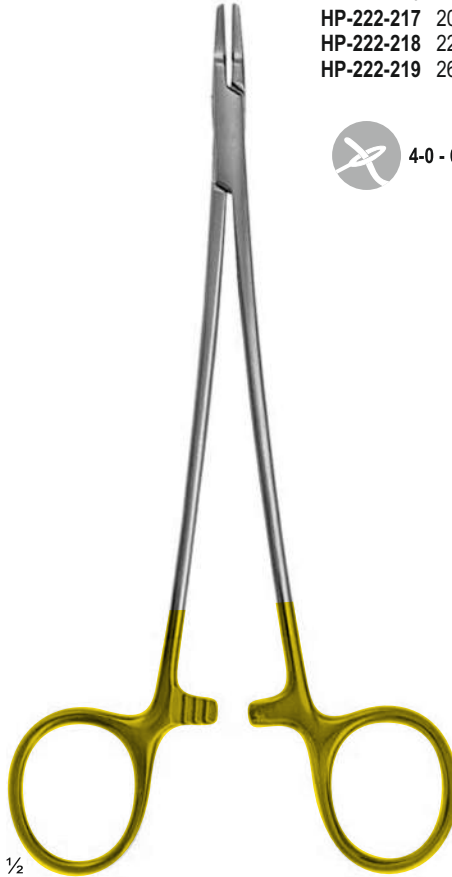

Ryder-Vascular
HP-222-214 - HP-222-219
23 cm
Micro profile, delicate pattern



- HP-222-220 14 cm
- HP-222-221 18.5 cm
- HP-222-222 20.5 cm
- HP-222-223 23 cm



Hegar-Vascular
HP-222-220 - HP-222-223
23 cm
Micro profile

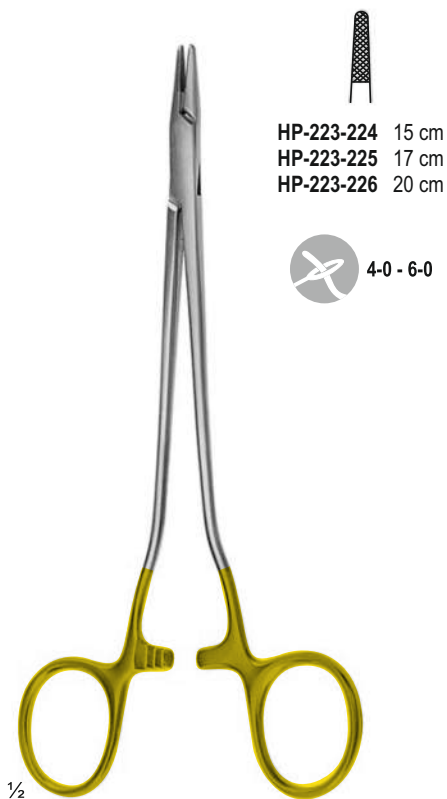

Schwedisches Modell
HP-223-224 - HP-223-226
20 cm



Finochietto
HP-223-227
27 cm
Standard profile



Wangenstein
HP-223-228
27 cm
Standard profile



HP-224-229
For sternum Suture
15 cm



4-0 - 6-0

Barry Sternal
HP-224-229 - HP-224-230
20 cm

1/2

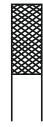

HP-224-230
Wire twister
20 cm



4-0 - 6-0

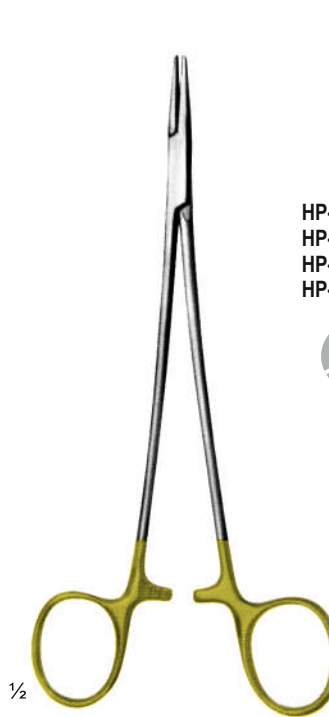

HP-224-231 14 cm
HP-224-232 17.5 cm
HP-224-233 20 cm
HP-224-234 23 cm



5-0 - 8-0

Barry Sternal
HP-224-231 - HP-224-234
17.5 cm
Micro profile, delicate pattern

1/2

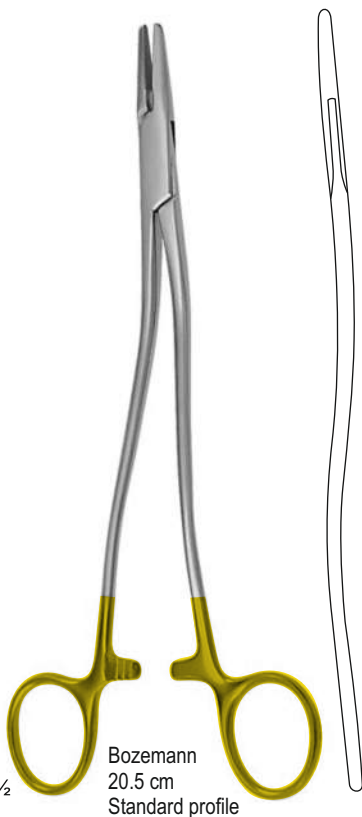

HP-224-235 - HP-224-238
HP-224-235 20.5 cm
HP-224-236 24 cm
HP-224-237 26 cm
HP-224-238 29 cm



4-0 - 6-0

Bozemann
20.5 cm
Standard profile

1/2

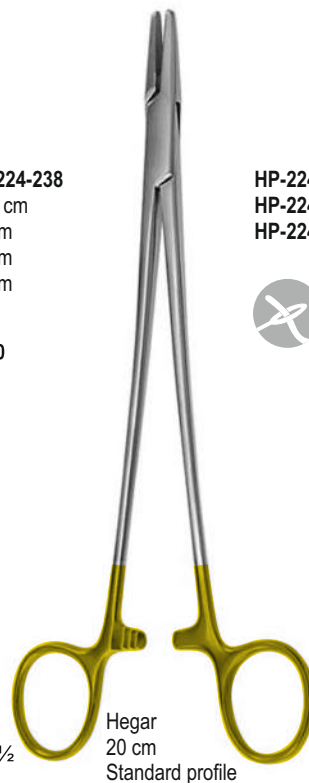

HP-224-239 - HP-224-240
HP-224-239 20.5 cm
HP-224-240 24 cm



4-0 - 6-0

Hegar
20 cm
Standard profile

1/2

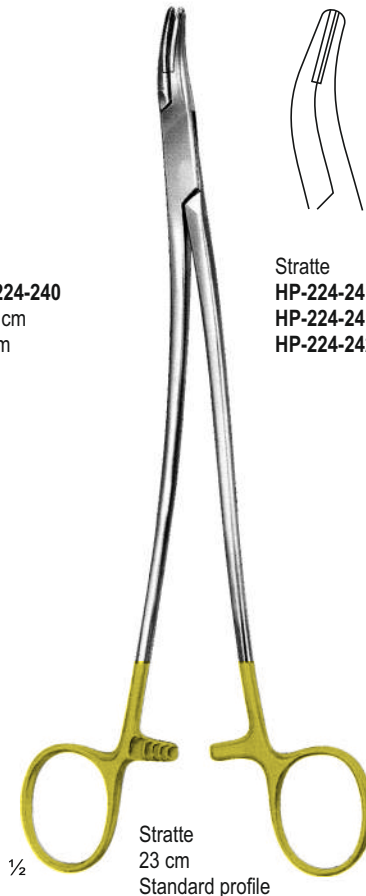

Stratte
HP-224-241 - HP-224-242
HP-224-241 22 cm
HP-224-242 23 cm

Stratte
23 cm
Standard profile

1/2



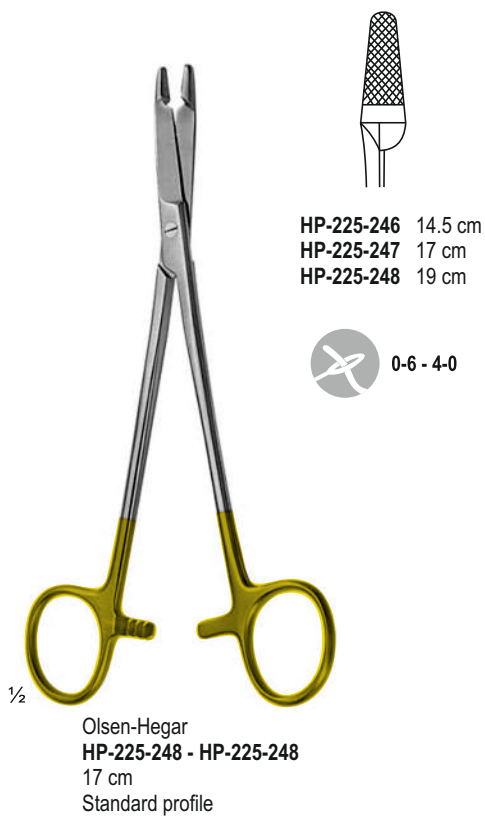
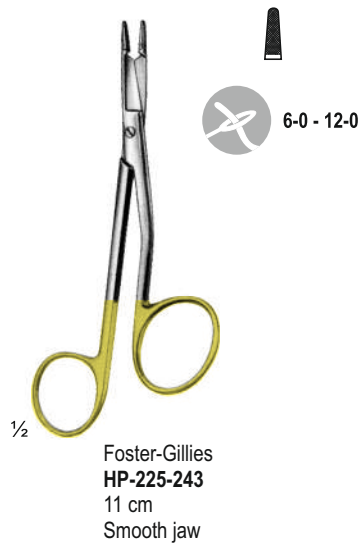



HP-226-253 14 cm
HP-226-254 17 cm
HP-226-255 20 cm



0-6 - 4-0

Mathieu
HP-226-253 - HP-226-255
14 cm
Standard profile

1/2



HP-226-256 14 cm
HP-226-257 17 cm
HP-226-258 20 cm



0-6 - 4-0

Mathieu
HP-226-256 - HP-226-258
17 cm
Standard profile

1/2



HP-226-259 17 cm
HP-226-260 20 cm
HP-226-261 23 cm



0-6 - 4-0

Mathieu
HP-226-259 - HP-226-261
20 cm
Standard profile, with interior ratchet

1/2



0-6 - 4-0

Lichtenberg
HP-226-262
20 cm
Standard profile

1/2



HP-226-263 20.5 cm
HP-226-264 23 cm



0-6 - 4-0

Zweifel
HP-226-263 - HP-226-264
20.5 cm
Standard profile, with hinged ratchet

1/2



Dressing

Dressing

Vestir

Vendaje

Page 228-234

Bandage Scissors, Plaster Shears

Verbandschere, Gipsschere]
Tesoura de bandagem, tesoura de gesso
Vendaje, tijeras, yeso, tijeras

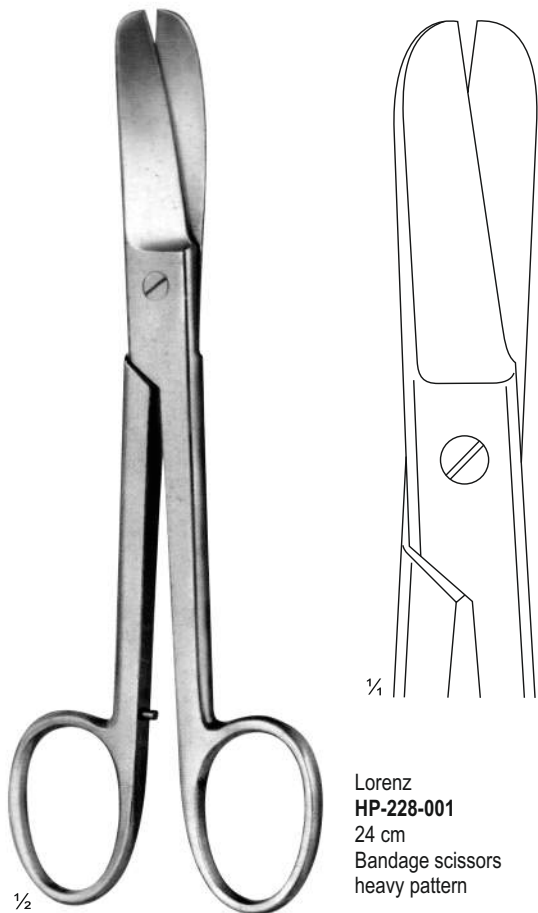

Lorenz
HP-228-001
24 cm
Bandage scissors
heavy pattern

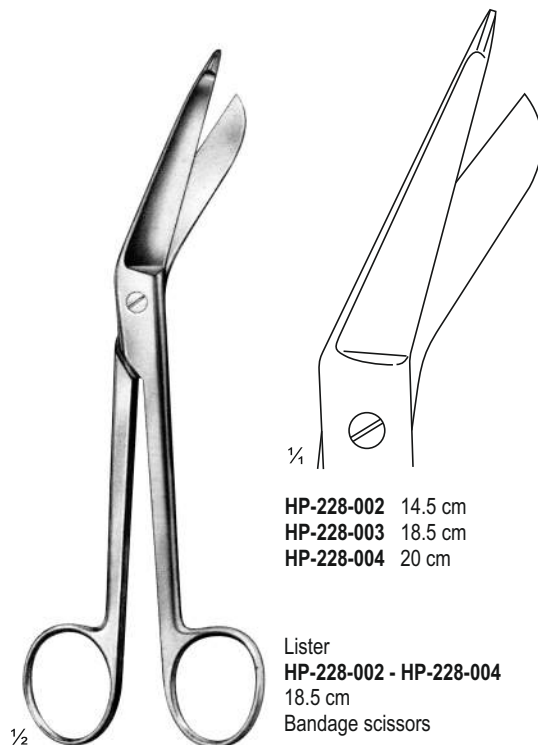

HP-228-002 14.5 cm
HP-228-003 18.5 cm
HP-228-004 20 cm

Lister
HP-228-002 - HP-228-004
18.5 cm
Bandage scissors

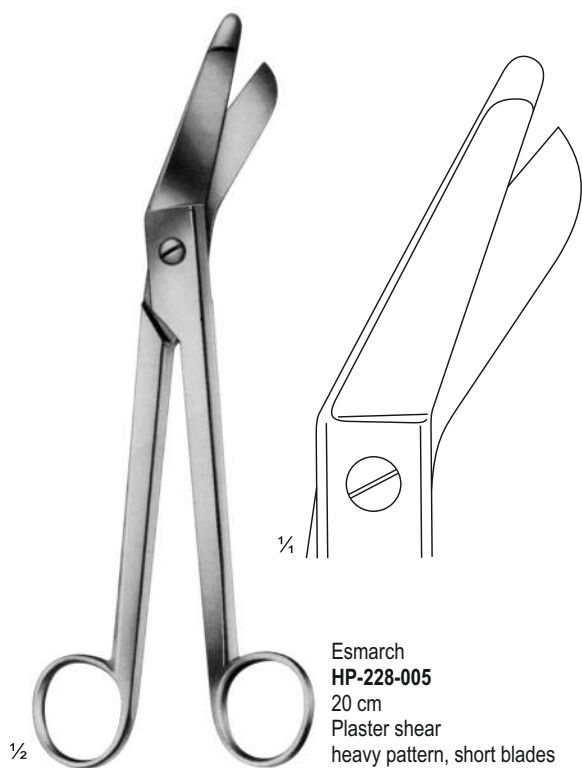

Esmarch
HP-228-005
20 cm
Plaster shear
heavy pattern, short blades

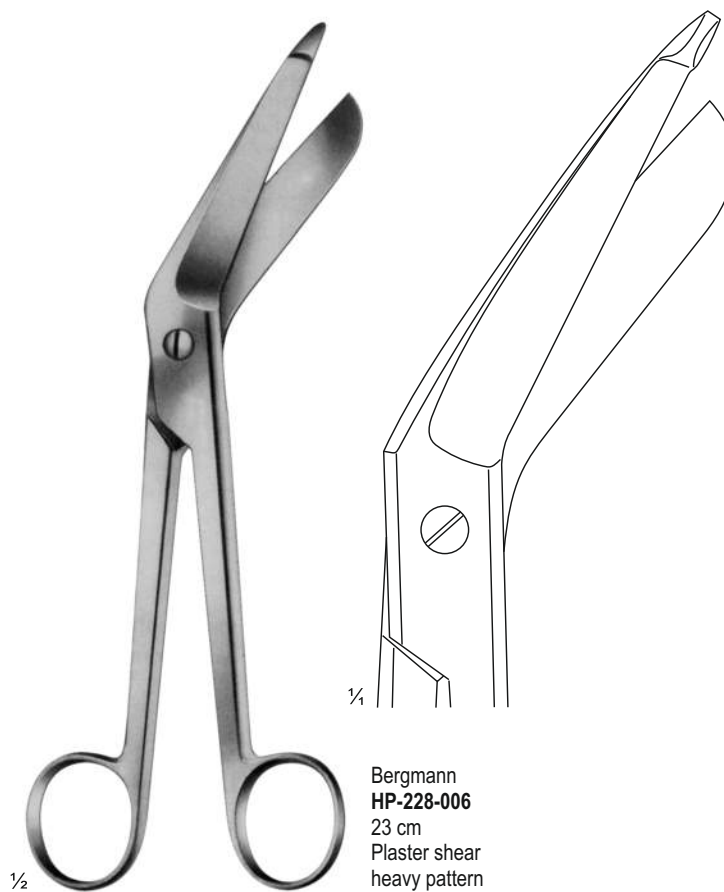

Bergmann
HP-228-006
23 cm
Plaster shear
heavy pattern



1/2
 Bruns
 HP-229-007 - HP-229-008
 Plaster scissors

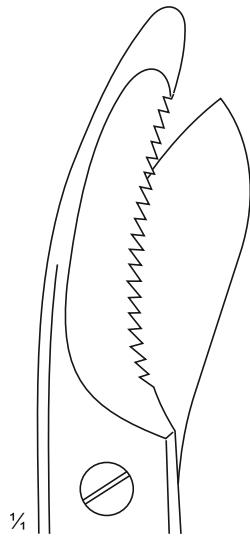

HP-229-007
 24 cm
 One toothed cutting edge



HP-229-008
 24 cm



1/2
 Seutin
 HP-229-009
 23 cm
 Plaster shear



1/2
 Universal
 HP-229-010 - HP-229-011
 15.5 cm
 Bandage scissors
 Black plastic rings, autoclavable

HP-229-010 15.5 cm
 HP-229-011 19 cm

Bandage Scissors, Plaster Scissors

Verbandschere, Gipsschere
Tesoura De Bandagem, Tesoura De Gesso
Vendaje, tijera, yeso, tijera

TC GOLG

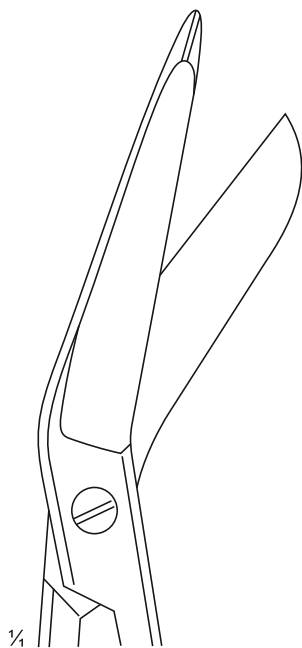

1/2

Lister
HP-230-012
18 cm
Bandage scissors

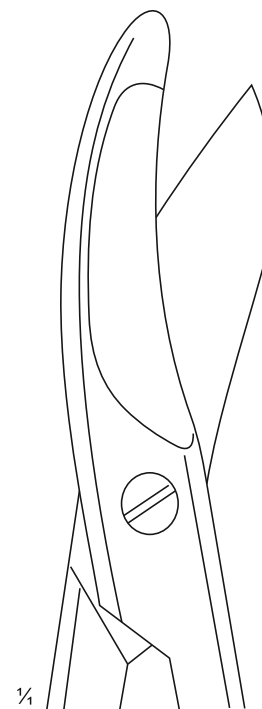

1/2

Bruns
HP-230-013
23.5 cm
Plaster scissors

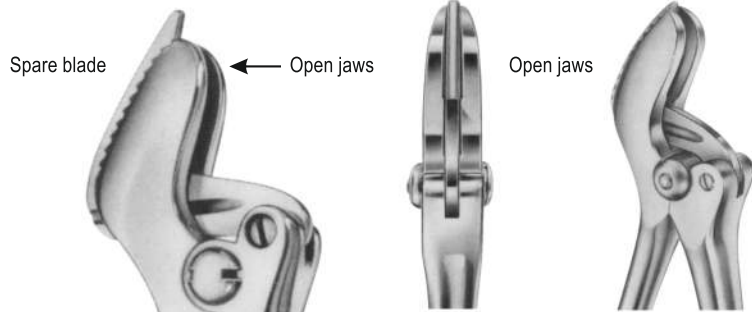

Stille
HP-231-014
36 cm



Stille
HP-231-015
26 cm

Plaster Shears
Gipsschere
Tesouras de gesso
Tijeras de yeso



Stille
HP-232-016
23 cm

HP-232-017
Spare blade



Stille
HP-232-020
37 cm

HP-232-021
Spare blade



Stille
HP-232-018
24 cm

HP-232-019
Spare blade



1/2

Esmarch
HP-233-022
18 cm



1/2

Reiner
HP-233-023
18 cm



1/2

Hopkins
HP-233-024
20 cm
with wooden handle



1/2

Engel
HP-233-025
16 cm

Plaster Spreader, Plaster Breakers

Gipsspreizer, Pflasterbrecher
Espalhador de gesso, disjuntores de gesso
Esparcidor de yeso, rompedores de yeso

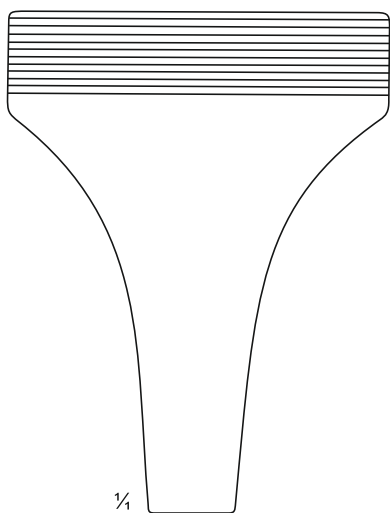

¼

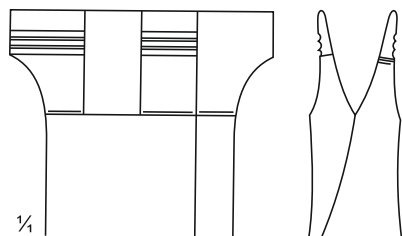

¼



½

Hennig
HP-234-026
28 cm
Plaster spreader



½

Quattro
HP-234-027
23 cm
Plaster spreader



½

Wolff
HP-234-028 - HP-234-029
17.5 cm
Plaster Breaker

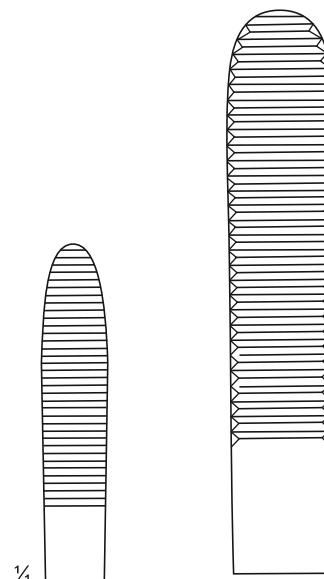

¼

HP-234-028
17.5 cm

HP-234-026
26.5 cm



Cardiovascular Surgery

Herz-Kreislauf-Chirurgie

Cirurgia Cardiovascular

Cirurgía Cardiovascular

Page 235-275

Rib Shears
Rippenscheren
Tesoura De Costela
Tijeras de costillas



½

HP-235-001
23 cm
Bone Shears



½

HP-235-002
23 cm



½

Gluck
HP-235-003
21 cm
Drawing cut



1/2

Collin
HP-236-004
19.5 cm



1/2

Gluck
HP-236-005
19 cm



1/2

Schumacher
HP-236-006
21 cm
Sternum shears

Rib Shears
Rippenscheren
Tesoura De Costela
Tijeras de costillas



Sauerbruch
HP-237-007
26 cm



Giertz-Stille
HP-237-008
24.5 cm



Bethune
HP-237-009
34.5 cm



Killian
HP-238-010
20 cm



Lebsche
HP-238-011
24,5 cm
Sternum chisel



Brunner
HP-238-012
32 cm

Rib Retractors
Rippen-Reraktoren
Retradores de Costela
Retradores de costillas



HP-239-013 - HP-239-018
HP-239-013 Stainless steel
HP-239-014 Aluminium
For blades, with 2 pairs of blades
9 x 20 mm 9 x 10 mm, spreading 52 mm



HP-239-015 Stainless steel
HP-239-016 Aluminium
Blades, only
9 x 20 mm



HP-239-017 Stainless steel
HP-239-018 Aluminium
Blades, only
9 x 10 mm



Cooley
HP-239-019 - HP-239-020
HP-239-019 Stainless steel
HP-239-020 Aluminium
For blades, lateral blades 12 x 16 mm,
spreading 95 mm



Cooley
HP-239-021 - HP-239-022
HP-239-021 Stainless steel
HP-239-022 Aluminium
For children, lateral blades 15 x 30 mm,
spreading 140 mm



Cooley
HP-239-023 - HP-239-024
HP-239-023 Stainless steel
HP-239-024 Aluminium
For children, lateral blades 21 x 44 mm,
spreading 150 mm



Cooley
HP-240-025 - HP-240-026
HP-240-025 Stainless steel
HP-240-026 Aluminium
 For adults, lateral blades 35 x 50 mm,
 spreading 200 mm

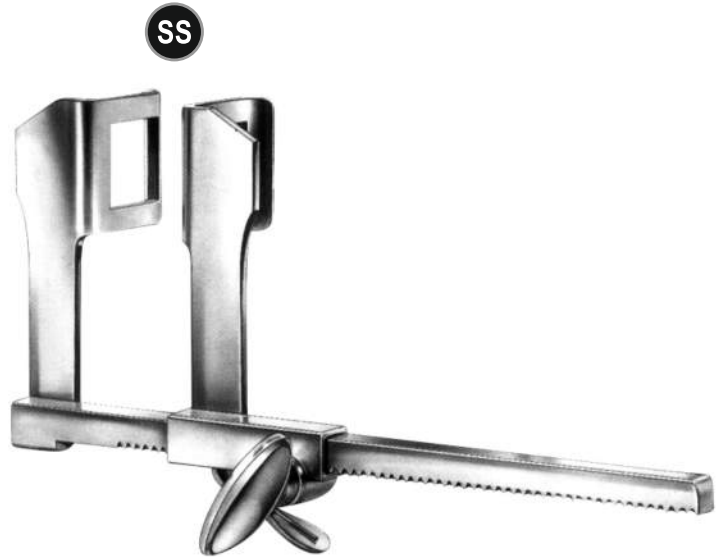

Haight
HP-240-027 Stainless steel
 Lateral blades 30 x 30 mm,
 spreading 120 mm

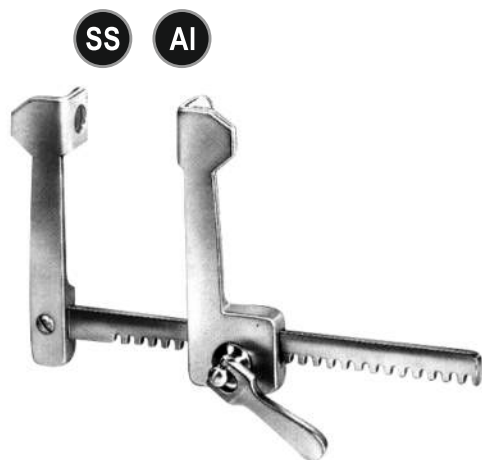

Finochietto, Infant
HP-240-028 - HP-240-029
HP-240-028 Stainless steel
HP-240-029 Aluminium
 For babies, lateral blades 15 x 15 mm,
 spreading 75 mm



Finochietto, Baby
HP-240-030 - HP-240-031
HP-240-030 Stainless steel
HP-240-031 Aluminium
 For children, lateral blades 31 x 31 mm,
 spreading 100 mm

Rib Retractors
Rippen-Reraktoren
Retradores de Costela
Retradores de costillas

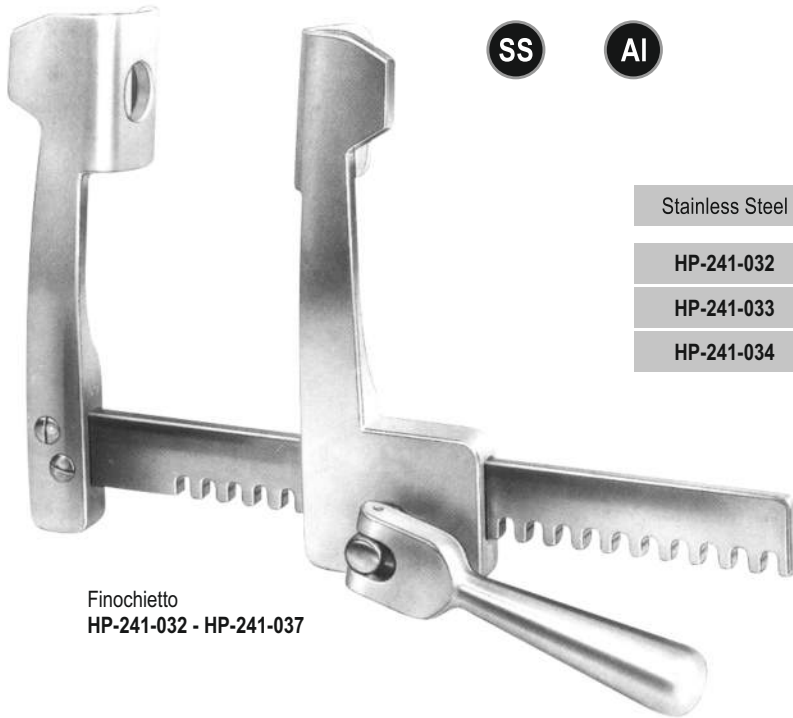

SS

Al

Finochietto
HP-241-032 - HP-241-037

Stainless Steel	Aluminium	Lateral Blades	Spreading
HP-241-032	HP-241-035	40 x 45 mm	135 mm
HP-241-033	HP-241-036	52 x 62 mm	175 mm
HP-241-034	HP-241-037	85 x 65 mm	175 mm

SS

Al



Burford
HP-241-038 - HP-241-043

Stainless Steel	Aluminium	With two pairs of blades	Spreading
HP-241-038	HP-241-041	47 x 62 mm + 65 x 62 mm	200 mm
HP-241-039	HP-241-042	47 x 62 mm + 65 x 62 mm	260 mm
HP-241-040	HP-241-043	47 x 62 mm + 65 x 62 mm	300 mm

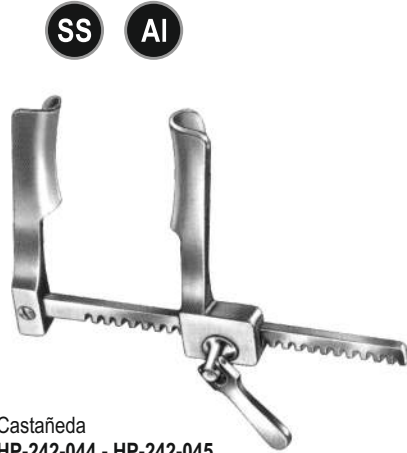

Castañeda
HP-242-044 - HP-242-045
HP-242-044 Stainless steel
HP-242-045 Aluminium
For babies, lateral blades 10.5 x 32 mm
spreading 65 mm



Castañeda
HP-242-046 - HP-242-047
HP-242-046 Stainless steel
HP-242-047 Aluminium
For infants, lateral blades 12 x 45 mm
spreading 70 mm



Castañeda
HP-242-048 - HP-242-049
HP-242-048 Stainless steel
HP-242-049 Aluminium
For infants, lateral blades 15 x 60 mm
spreading 120 mm



Finochietto (modif.)
HP-242-050 - HP-242-051
HP-242-050 Stainless steel
HP-242-051 Aluminium
Lateral blades 14 x 15 mm
spreading 120 mm

Rib Retractors
Rippen-Reraktoren
Retradores de Costela
Retradores de costillas

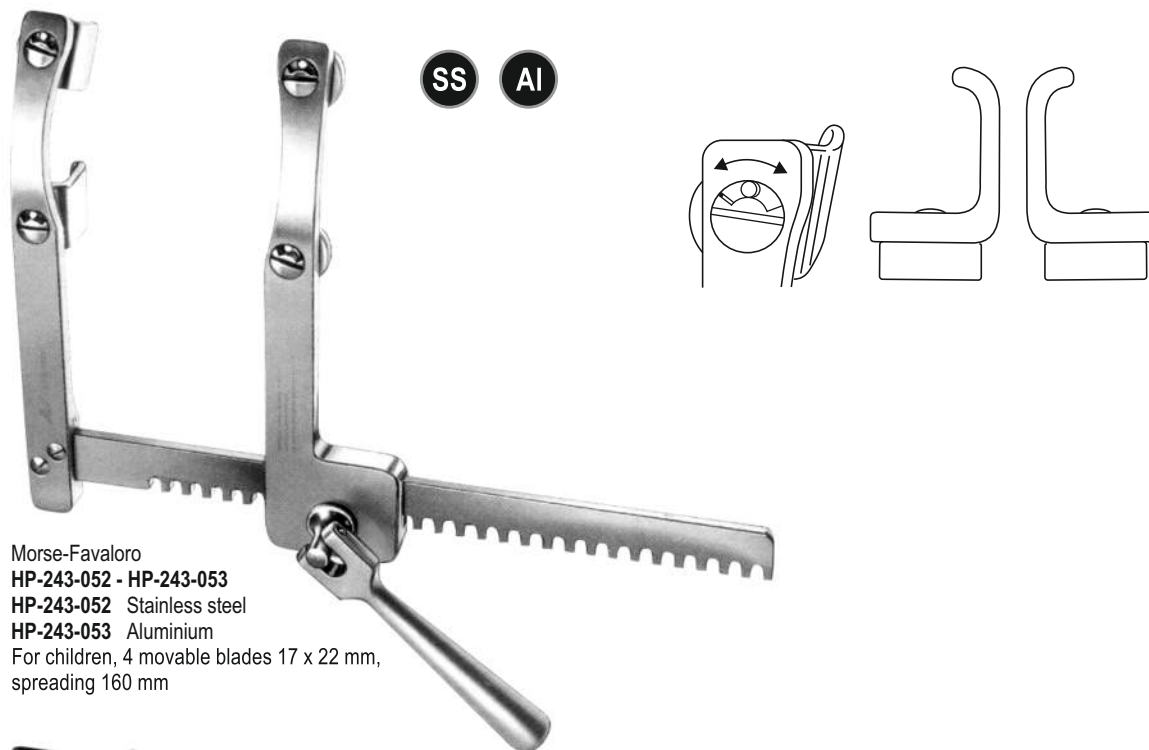

Morse-Favaloro
HP-243-052 - HP-243-053
HP-243-052 Stainless steel
HP-243-053 Aluminium
For children, 4 movable blades 17 x 22 mm,
spreading 160 mm

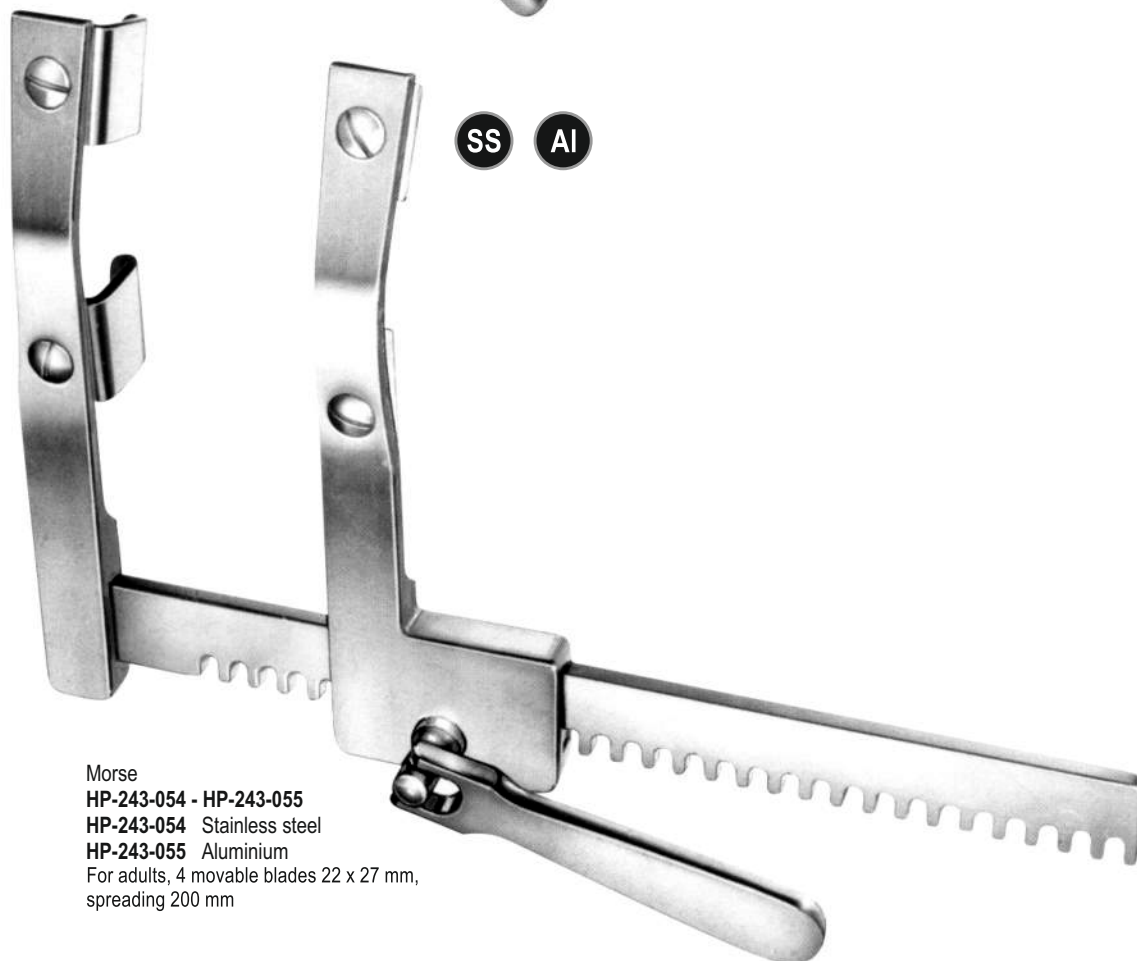

Morse
HP-243-054 - HP-243-055
HP-243-054 Stainless steel
HP-243-055 Aluminium
For adults, 4 movable blades 22 x 27 mm,
spreading 200 mm



Tuffier
HP-244-056 Stainless steel
Lateral blades 45 x 45 mm,
spreading 160 mm

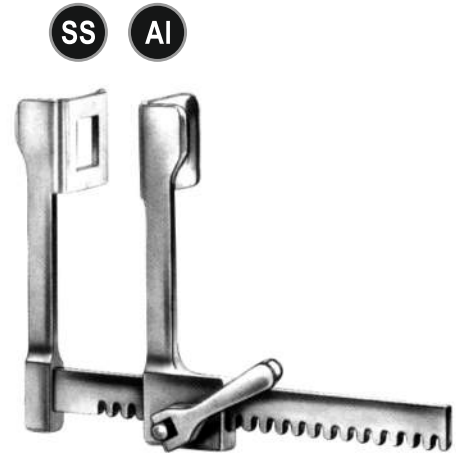

Finochietto, Baby
HP-244-057 - HP-244-058
HP-244-057 Stainless steel
HP-244-058 Aluminium
Lateral blades 14 x 15 mm,
spreading 75 mm



Finochietto
HP-244-059 - HP-244-064

Stainless Steel	Aluminium	Lateral Blades	Spreading
HP-244-059	HP-244-062	30 x 45 mm	150 mm
HP-244-060	HP-244-063	46 x 62 mm	190 mm
HP-244-061	HP-244-064	80 x 65 mm	190 mm

Rib Retractors
Rippen-Reraktoren
Retradores de Costela
Retradores de costillas

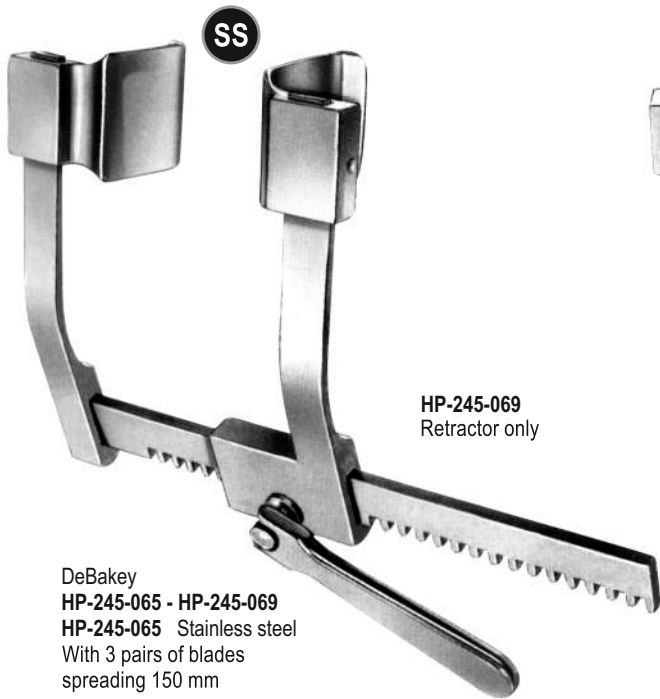

DeBakey
HP-245-065 - HP-245-069
HP-245-065 Stainless steel
With 3 pairs of blades
spreading 150 mm

HP-245-069
Retractor only



Fig. 1
Lateral blades
HP-245-066
30 x 30 mm



Fig. 2
Lateral blades
HP-245-067
40 x 40 mm

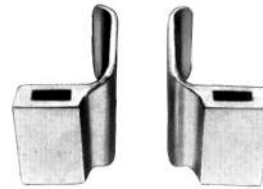

Fig. 3
Lateral blades
HP-245-068
50 x 50 mm



Fig. 1
Lateral blades
HP-245-070
60 x 60 mm



Fig. 2
Lateral blades
HP-245-071
50 x 80 mm

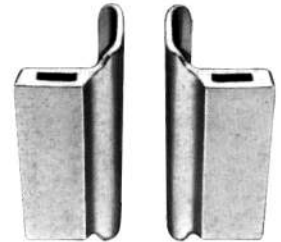
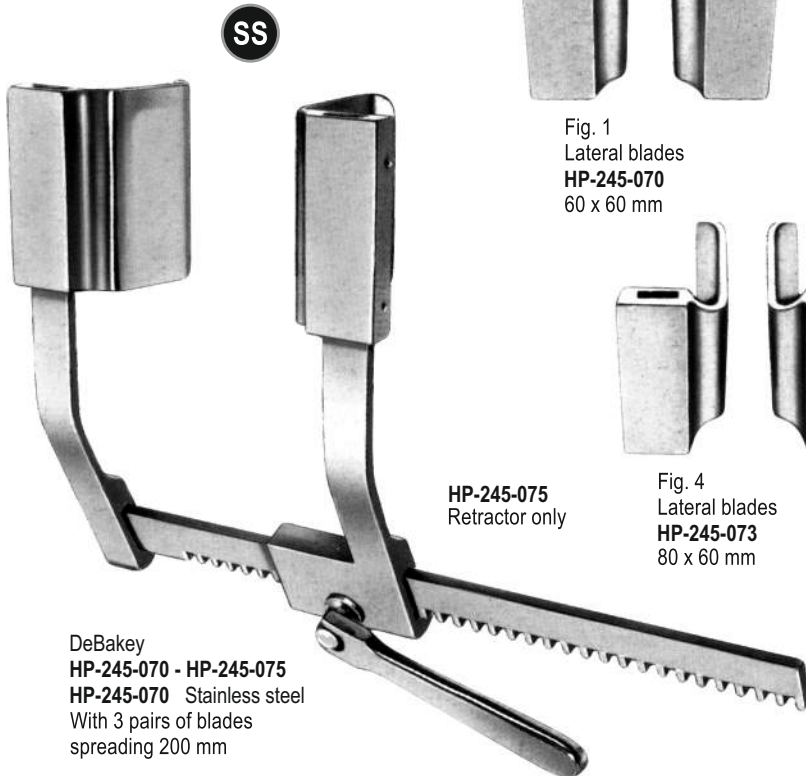

Fig. 3
Lateral blades
HP-245-072
40 x 100 mm



DeBakey
HP-245-070 - HP-245-075
HP-245-070 Stainless steel
With 3 pairs of blades
spreading 200 mm

HP-245-075
Retractor only

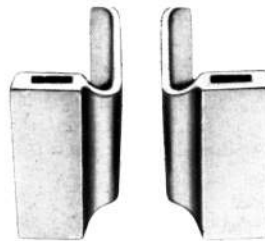

Fig. 4
Lateral blades
HP-245-073
80 x 60 mm



Fig. 5
Lateral blades
HP-245-074
50 x 66 mm



Mercedes Retractor
HP-246-076 - HP-246-078
With 1 pair of blades each

HP-246-078
Retractor only

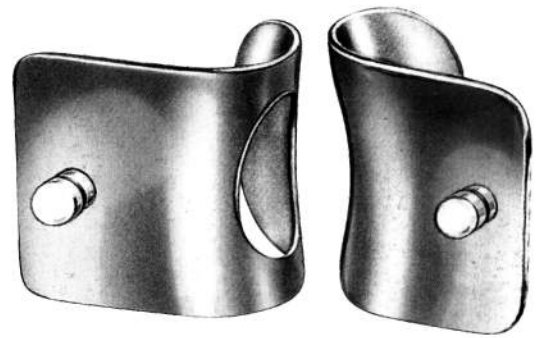

Fig. 1
Lateral blades pair
HP-246-076
48 x 68 mm

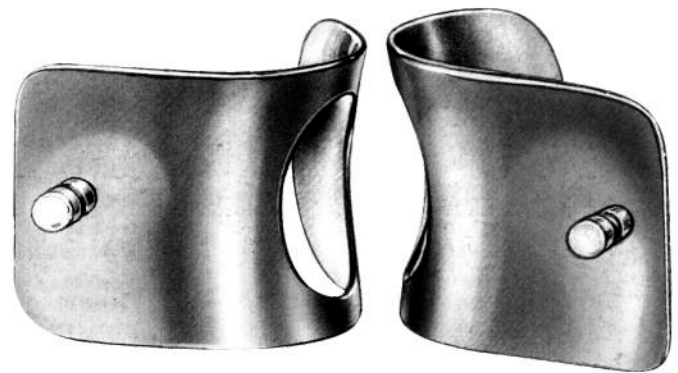

Fig. 2
Lateral blades pair
HP-246-077
70 x 75 mm

Bronchus Clamps
Bronchuskammern
Grampos de brônquio
Abrazaderas bronquiales

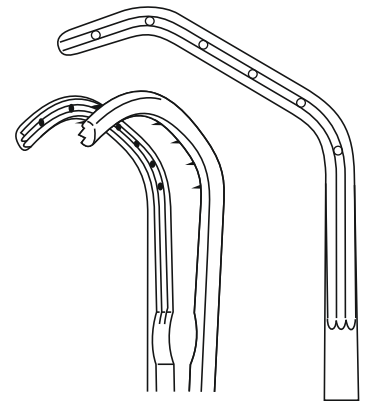
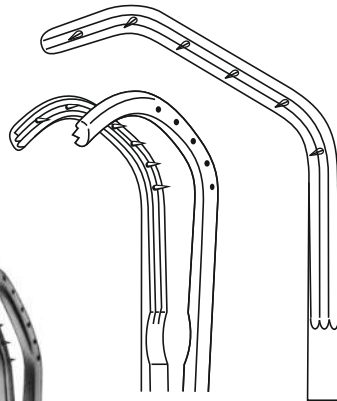
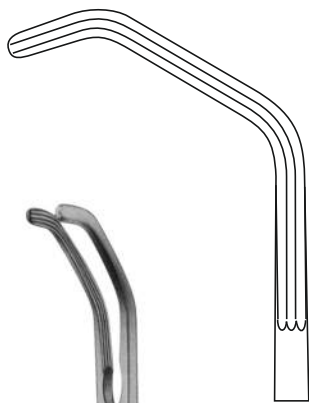

Fig. 1
HP-247-080

Fig. 2
HP-247-081



Price-Thomas
HP-247-079
22 cm



Price-Thomas
HP-247-080 - HP-247-081
22 cm



1/2 Lovelace
HP-248-082
 20.5 cm
 Lung grasping forceps

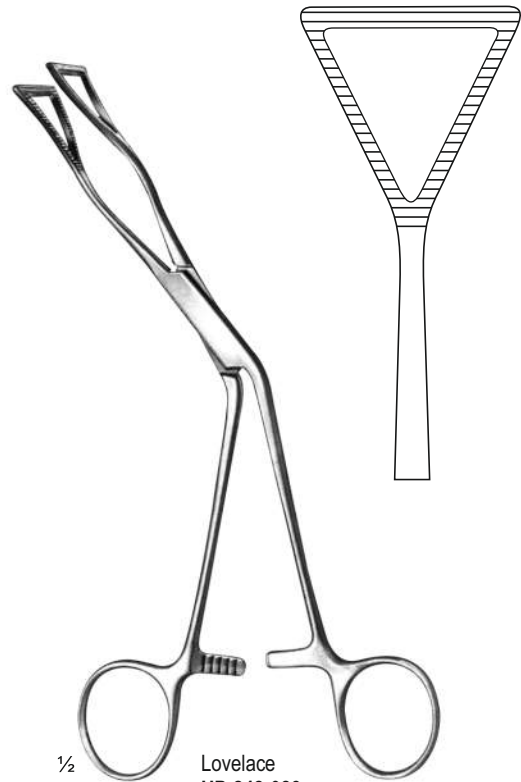

1/2 Lovelace
HP-248-083
 19 cm
 Lung grasping forceps

ATRAUMA



DeBakey-Rankin
HP-248-084 - HP-248-085
 16 cm

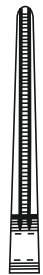

HP-248-084
 Straight



HP-248-085
 Curved



DeBakey-Mosquito
HP-248-086 - HP-248-087
 15 cm

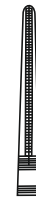

HP-248-086
 Straight



HP-248-087
 Curved

Rib Retractors
Rippen-Reraktoren
Retratores de Costela
Retradores de costillas

ATRAUMA



DeBakey-Satinsky
HP-249-088
7 cm

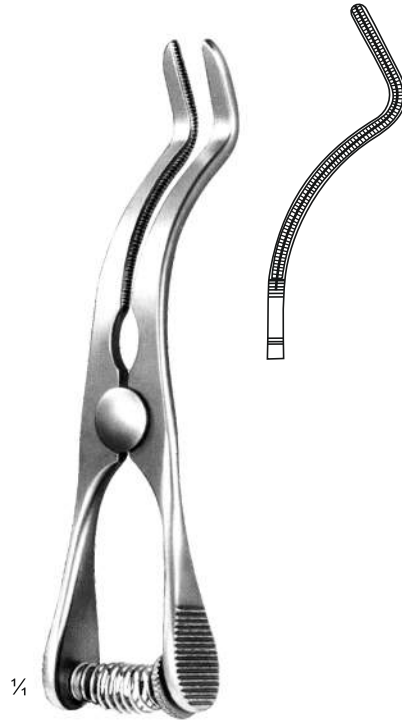

DeBakey-Satinsky
HP-249-089
9 cm

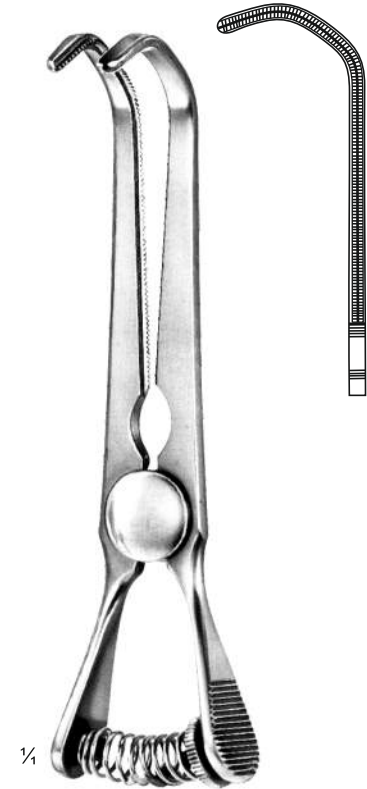

DeBakey-Satinsky
HP-249-090
10 cm



Glover
HP-249-091
6.5 cm



Santulli
HP-249-092
7 cm



Ochsner
HP-250-093
22 cm



Diethrich
HP-250-094
22 cm

ATRAUMA



HP-251-095
15 cm



HP-251-096
15.5 cm
15°

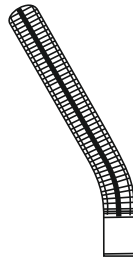

HP-251-097
15.5 cm
30°

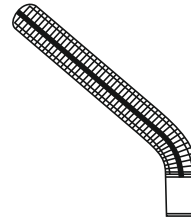

HP-251-098
15 cm
45°



HP-251-099
13.5 cm
90°

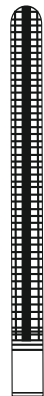

HP-251-100
17 cm

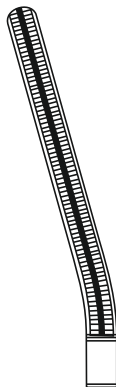

HP-251-101
16.5 cm
15°

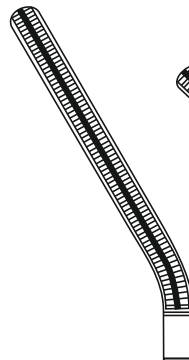

HP-251-102
16.5 cm
30°

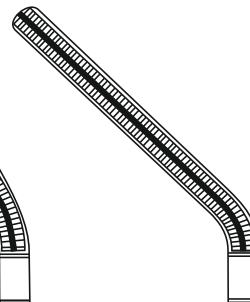

HP-251-103
17 cm
45°

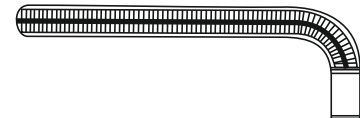

HP-251-104
13.5 cm
90°

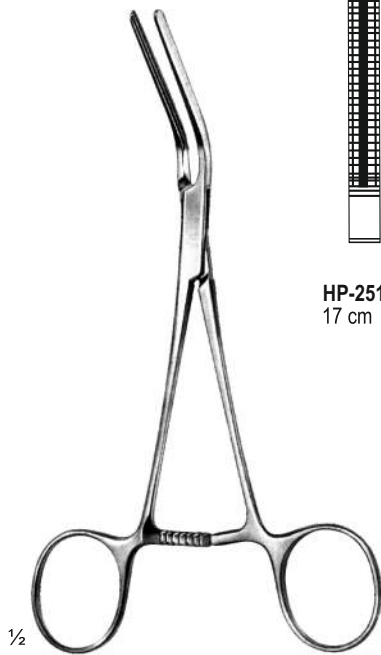

Dardik
HP-251-095 - HP-251-104
17 cm

ATRAUMA

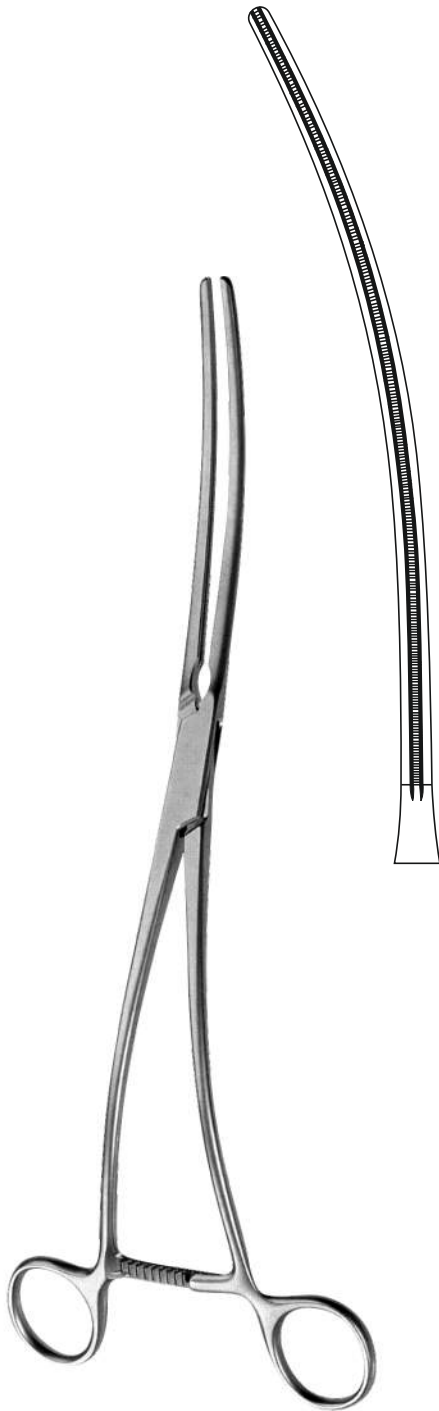

1/2

DeBakey
HP-252-105
30 cm
Aortic clamp

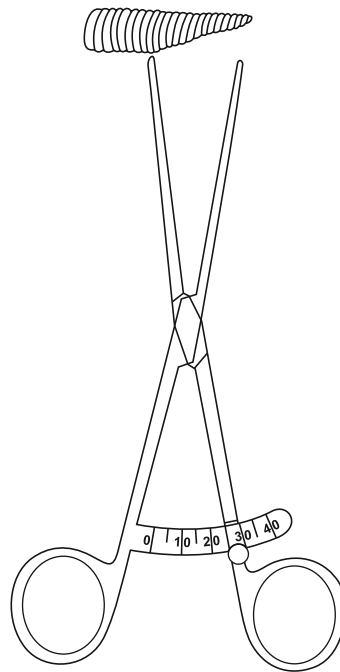
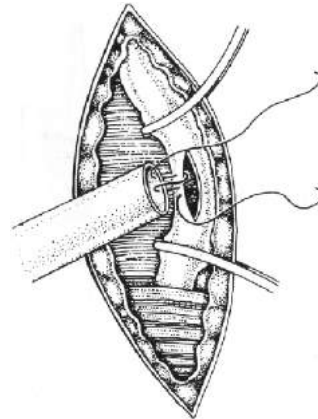

1/2

HP-252-106
18 cm
Vascular measuring device

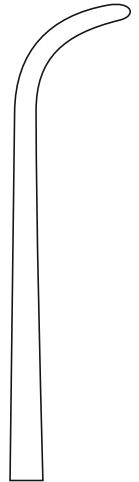

ATRAUMA

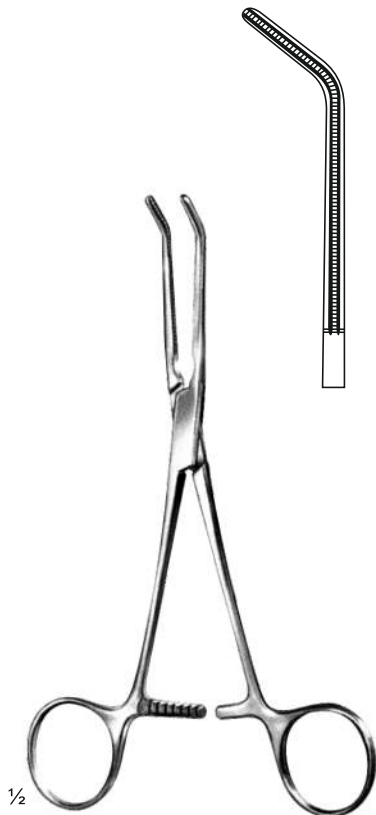
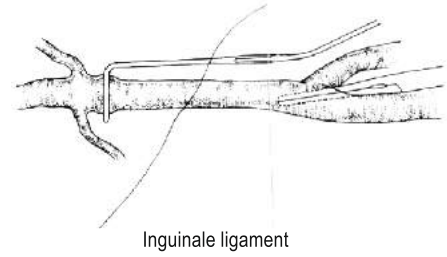
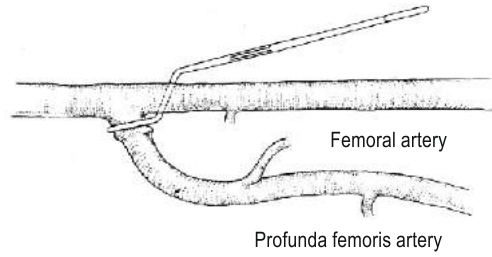

Husfeldt
HP-253-107
16.5 cm

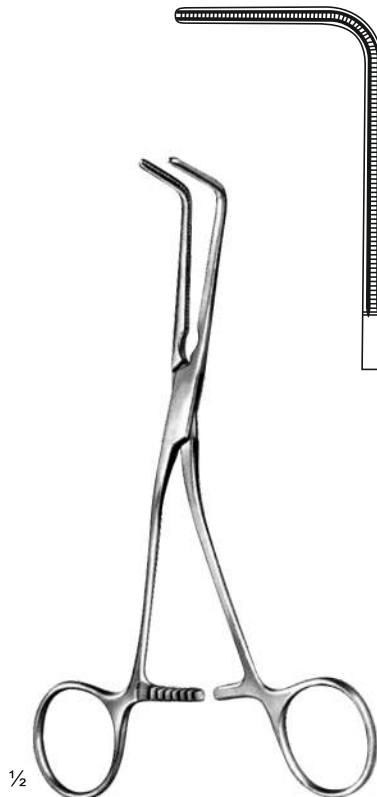

Husfeldt
HP-253-108
17 cm

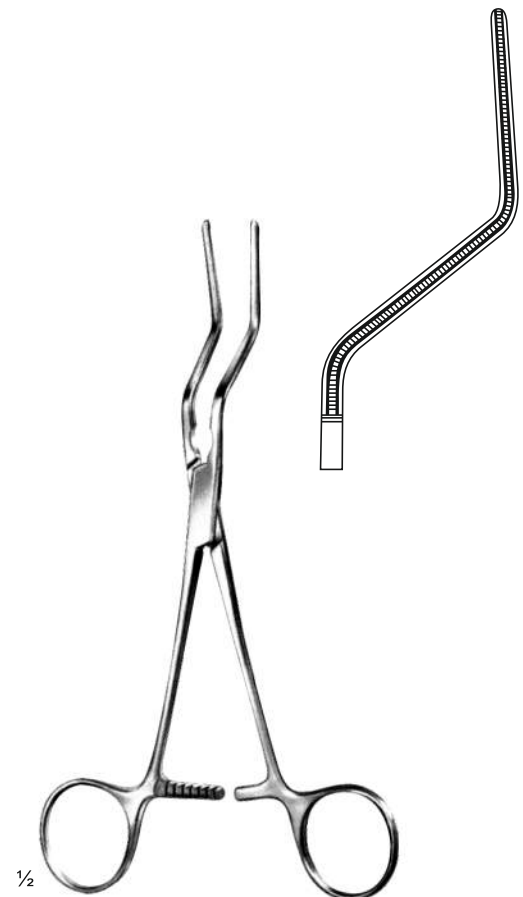

Husfeldt
HP-253-109
18 cm

ATRAUMA



DeBakey
HP-254-110 - HP-254-113
20 cm
2.7 mm

½

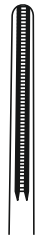

HP-254-110
16 cm



HP-254-111
20 cm



HP-254-112
25 cm

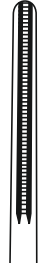

HP-254-113
30 cm



DeBakey
HP-254-114 - HP-254-116
20 cm
1.5 mm

½



HP-254-114
16 cm



HP-254-115
20 cm



HP-254-116
25 cm



DeBakey
HP-254-117 - HP-254-120
20 cm
2 mm

½



HP-254-117
16 cm

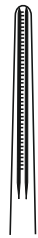

HP-254-118
20 cm



HP-254-119
25 cm



HP-254-120
30 cm

Vascular Forceps
Gefäßzange
Pinça Vascular
Pinzas Vasculares

ATRAUMA



½

DeBakey
HP-255-121 - HP-255-124
20 cm
2 mm



HP-255-121
16 cm



HP-255-122
19.5 cm



HP-255-123
25 cm



HP-255-124
29.5 cm



½

DeBakey
HP-255-125 - HP-255-128
20 cm
3.5 mm



HP-255-125
16 cm



HP-255-126
20 cm



HP-255-127
25 cm

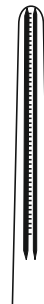

HP-255-128
30 cm

ATRAUMA



HP-256-129	15 cm	HP-256-132	15 cm
HP-256-130	19.5 cm	HP-256-133	19.5 cm
HP-256-131	24 cm	HP-256-134	24 cm
	1.0 mm		1.5 mm

DeBakey-Diethrich
HP-256-129 - HP-256-134



HP-256-135	15 cm	HP-256-140	15 cm
HP-256-136	19.5 cm	HP-256-141	19.5 cm
HP-256-137	24 cm	HP-256-142	24 cm
HP-256-138	30 cm	HP-256-143	30 cm
HP-256-139	38 cm	HP-256-144	38 cm
	2.7 mm		3.5 mm

DeBakey
HP-256-135 - HP-256-144



HP-256-145	15 cm
HP-256-146	19.5 cm
HP-256-147	24 cm
	2.0 mm

Cooley
HP-256-145 - HP-256-147



HP-256-148	15 cm
HP-256-149	19.5 cm
HP-256-150	24 cm
	1.5 mm



Chitwood-DeBakey
HP-256-148 - HP-256-150

1/2



HP-256-151	15 cm	HP-256-154	15 cm	HP-256-157	15 cm
HP-256-152	19.5 cm	HP-256-155	19.5 cm	HP-256-158	19.5 cm
HP-256-153	24 cm	HP-256-156	24 cm	HP-256-159	24 cm
	2.0 mm		2.7 mm		3.5 mm



Chitwood-DeBakey
HP-256-151 - HP-256-159

1/2

Coarctation Clamps
Coarctationsklemmen
Grampos de coarctação
Abrazaderas de coartación

ATRAUMA

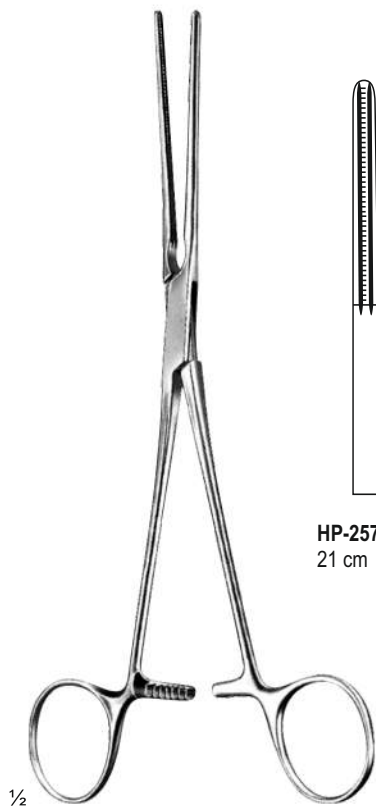

HP-257-160
21 cm

Potts
HP-257-160 - HP-257-161
21 cm

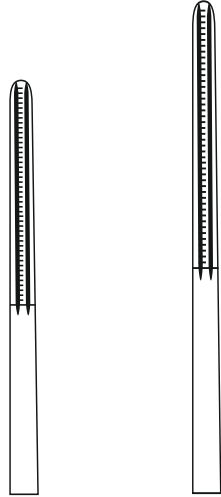

HP-257-161
22.5 cm



HP-257-162
20 cm

Potts
HP-257-162 - HP-257-163
20 cm

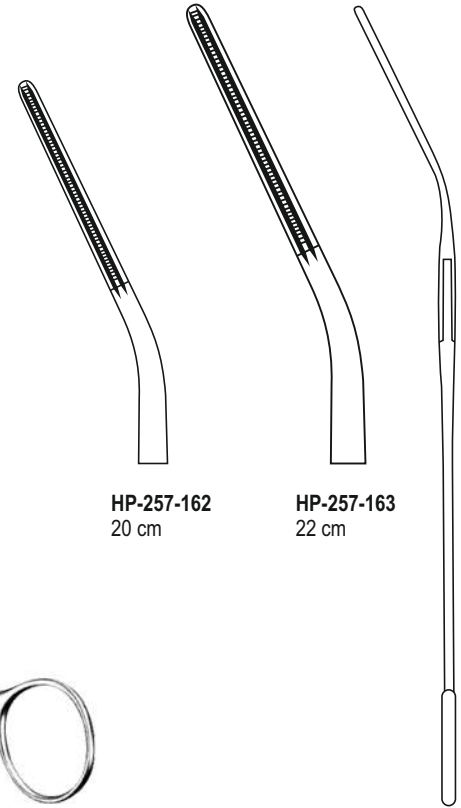

HP-257-163
22 cm



Potts
HP-257-164 - HP-257-155
20.5 cm

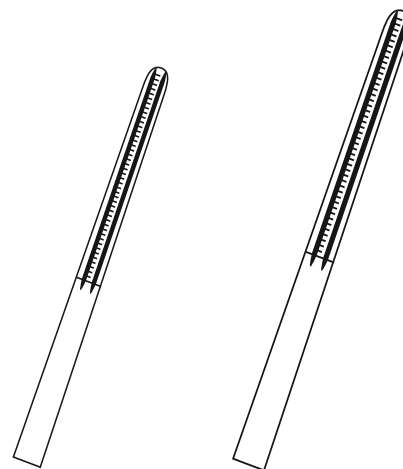

HP-257-164
20 cm

HP-257-165
22 cm

ATRAUMA



1/2
 Potts
 HP-258-166
 21.5 cm



1/2
 Potts
 HP-258-167
 22 cm

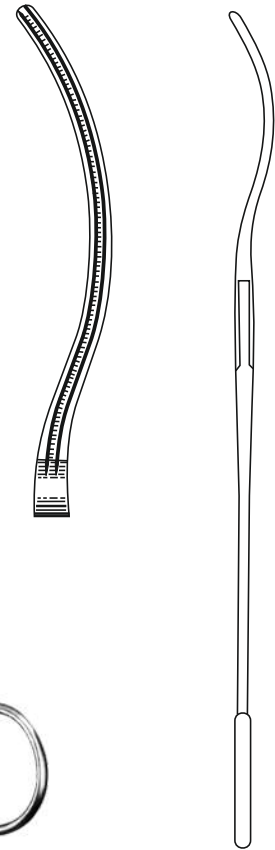

DeBailey
 HP-258-168 - HP-258-169
 19 cm
 Dissecting and ligature forceps

1/2

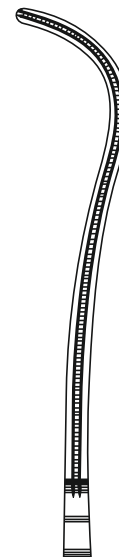

HP-258-168
 19 cm

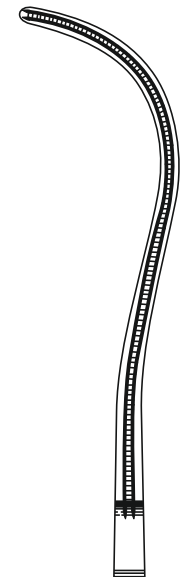

HP-258-169
 24 cm

Peripheral Vascular Clamps
Periphere Gefäßklemmen
Grampos vasculares periféricos
Pinzas vasculares periféricas

ATRAUMA

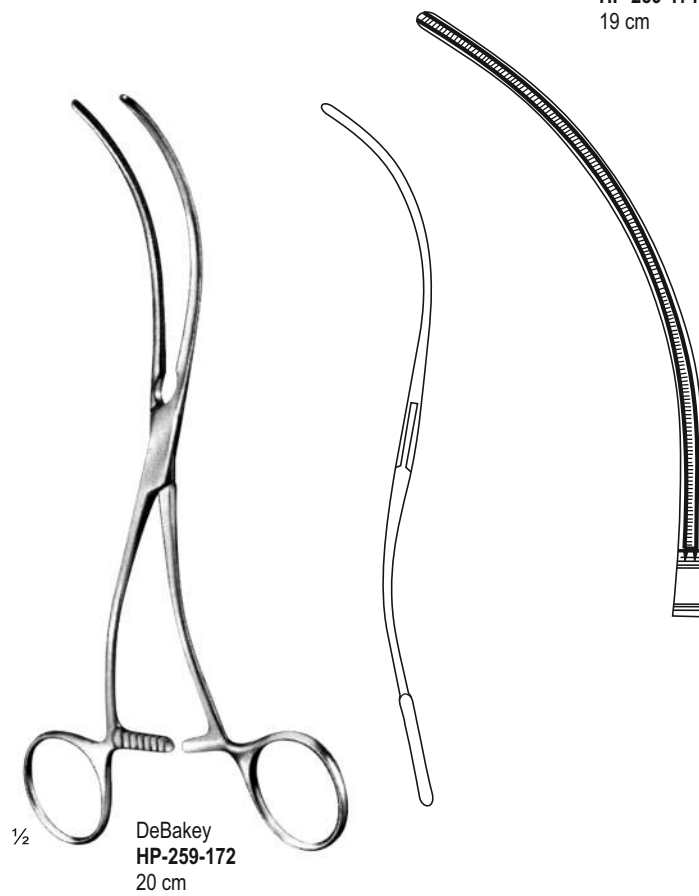

ATRAUMA

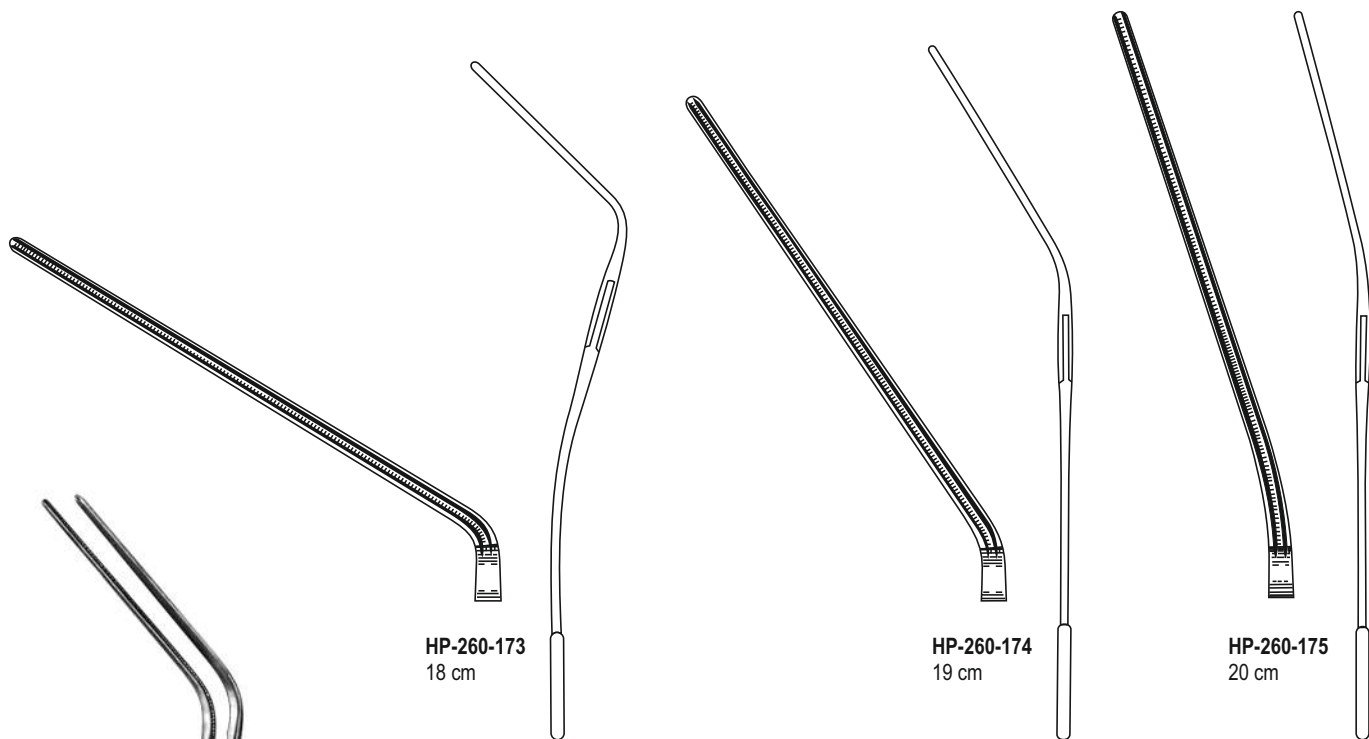

Leland-Jones
HP-260-173 - HP-260-175

Multi Purpose Vascular Clamps
Mehrzweck-Gefäßklemmen
Grampos vasculares de múltiplos propósitos
Abrazaderas vasculares multiusos

ATRAUMA



1/2

Bainbridge
HP-261-176 - HP-261-177
18.5 cm



HP-261-176
15 cm



HP-261-177
18.5 cm

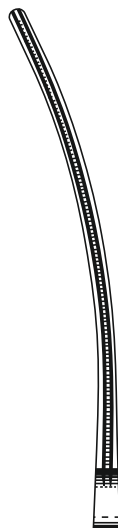

HP-261-178
15 cm

HP-261-179
18.5 cm



1/2

Bainbridge
HP-261-178 - HP-261-179
18.5 cm

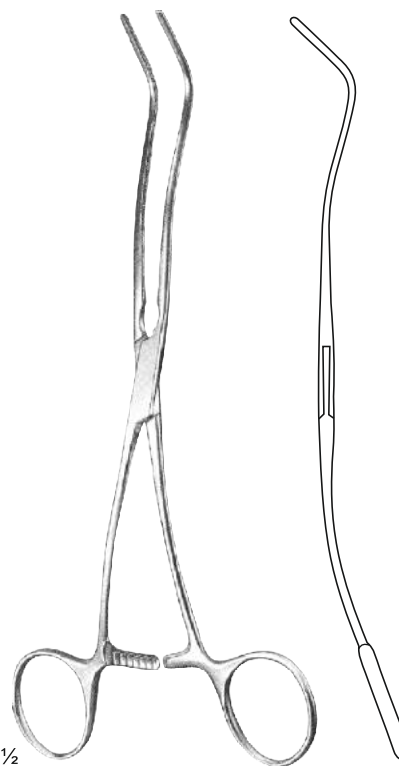

1/2

DeBakay
HP-261-180
20 cm

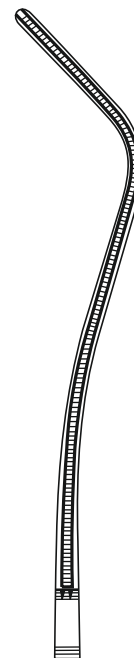

ATRAUMA

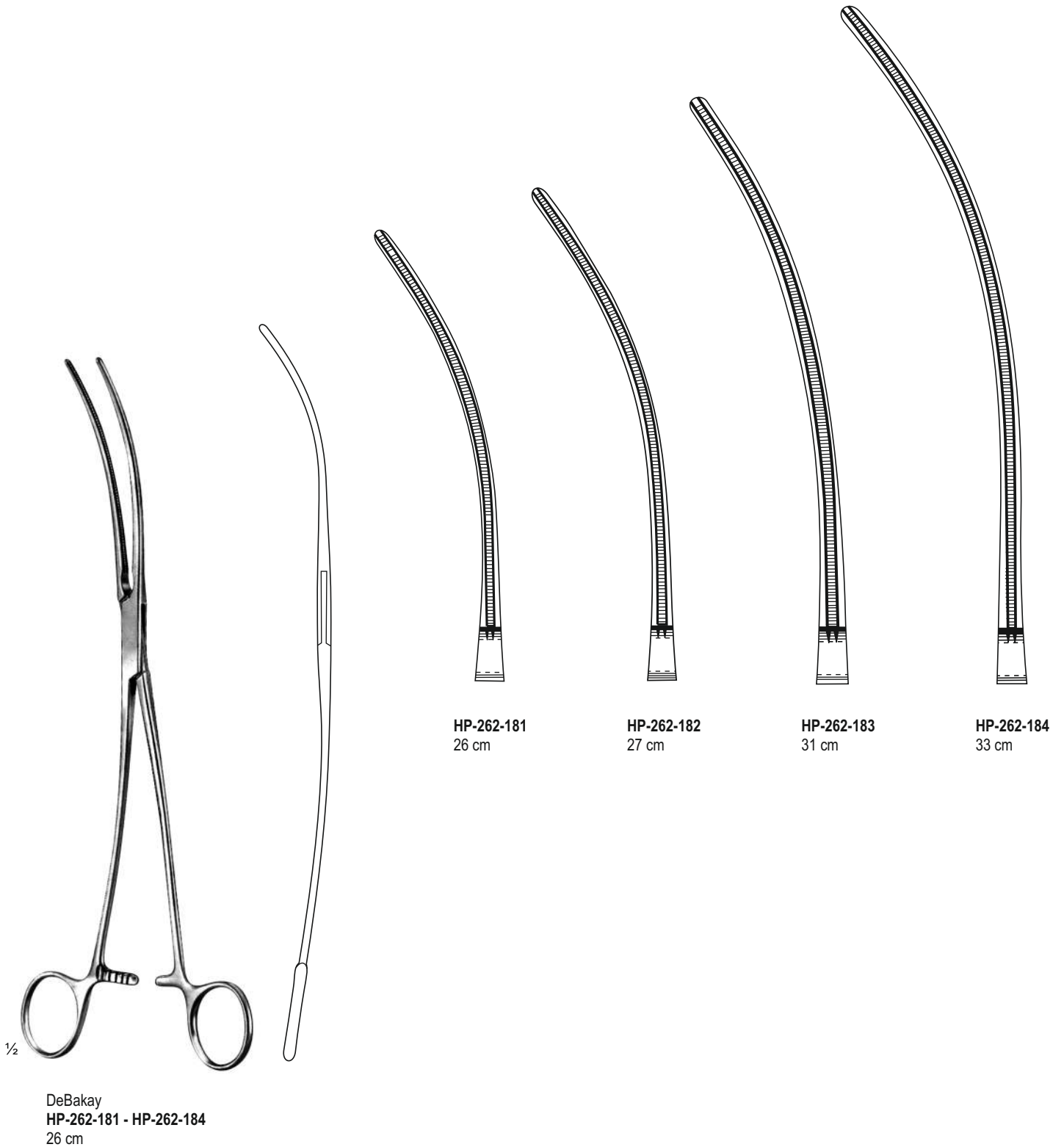

Aortic Aneurysm Clamps
Aortenaneurysma-Klammern
Grampos de aneurisma aórtico
Abrazaderas de aneurisma aórtico

ATRAUMA



1/2

DeBakay
HP-263-185
28 cm

1/2

DeBakay
HP-263-186
30 cm

ATRAUMA



Cooley
HP-264-187
25 cm

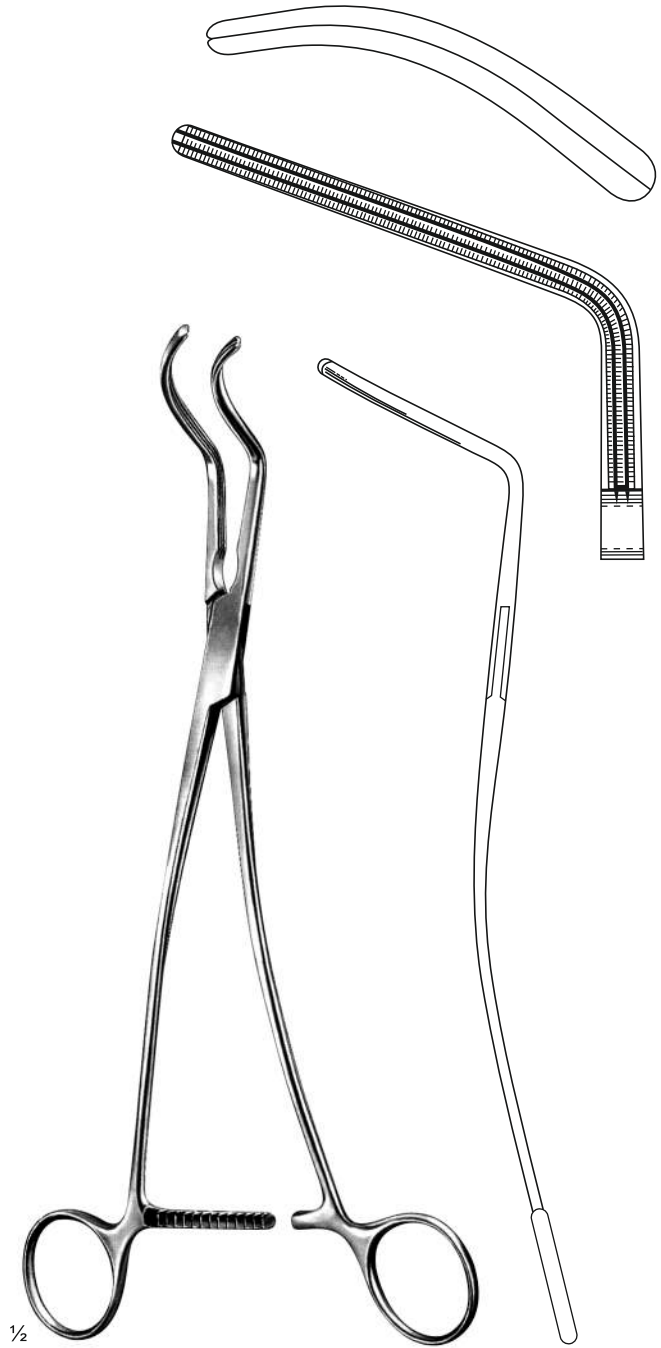

DeBakay
HP-264-188
27 cm

Ligature Forceps, Aortic Clamps
Ligatur Pinzetten, Aortenklappen
Pinça de Ligadura, Grampos Aórticos
Pinzas de ligadura, abrazaderas aórticas

ATRAUMA

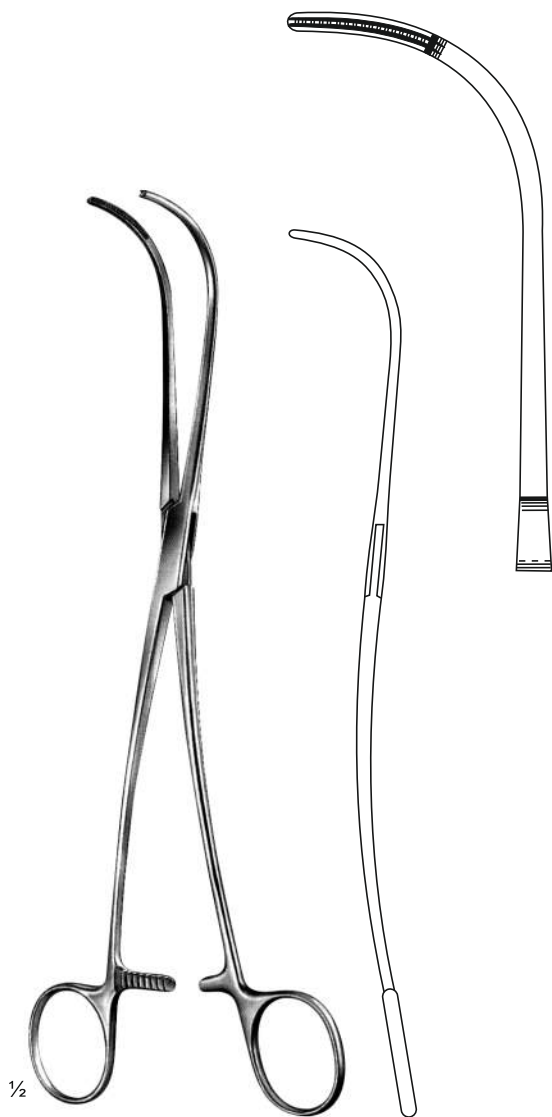

1/2

DeBakay
HP-265-189
24.5 cm
Ligature forceps

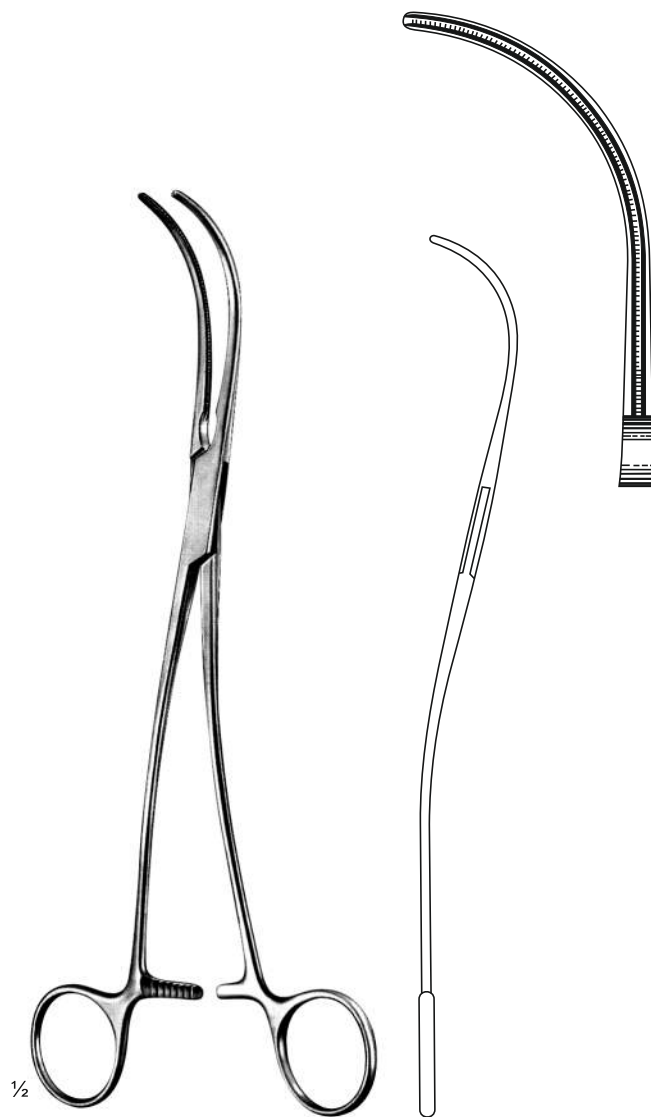

1/2

DeBakay
HP-265-190
24.5 cm
Aortic forceps

ATRAUMA



DeBakay
HP-266-191
27 cm



DeBakay
HP-266-192
27 cm

Tangential Occlusion Clamps
Tangentiale Okklusionsklemmen
Grampos de oclusão tangencial
Abrazaderas de oclusión tangencial

ATRAUMA

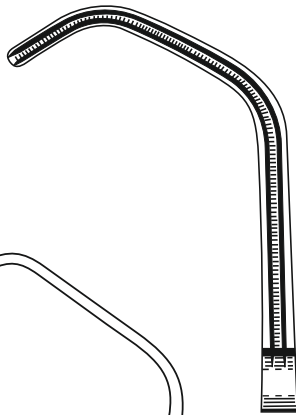
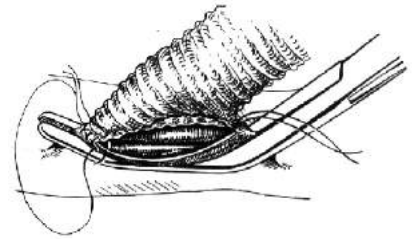

HP-267-193
22 cm

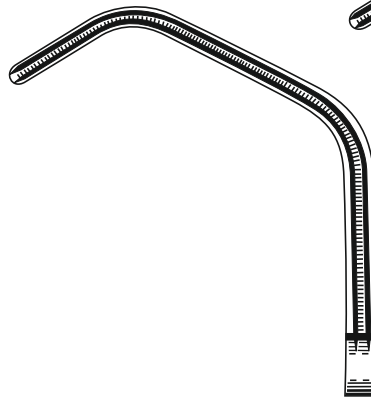

HP-267-194
26 cm

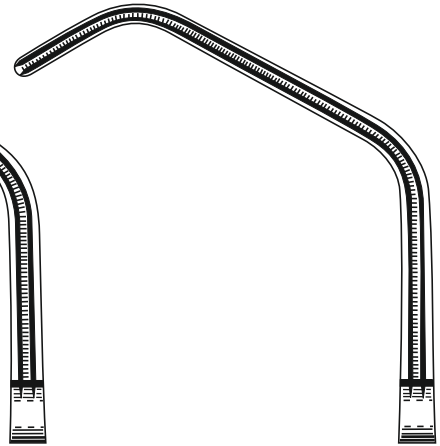

HP-267-195
26.5 cm



1/2 Satinsky
HP-267-193 - HP-267-197
28.5 cm



HP-267-196
27.5 cm

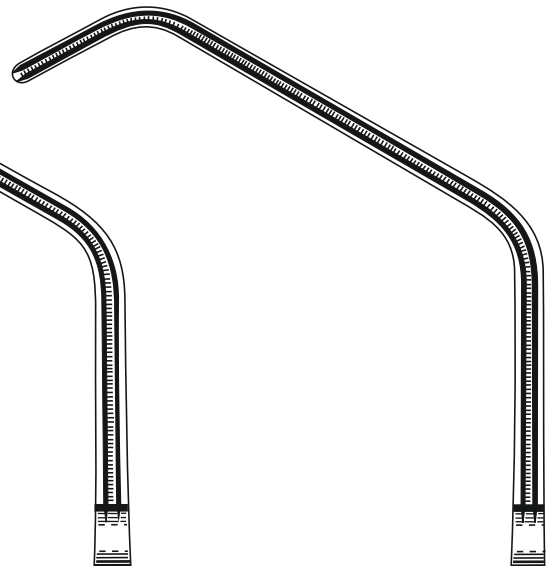

HP-267-197
28.5 cm

ATRAUMA

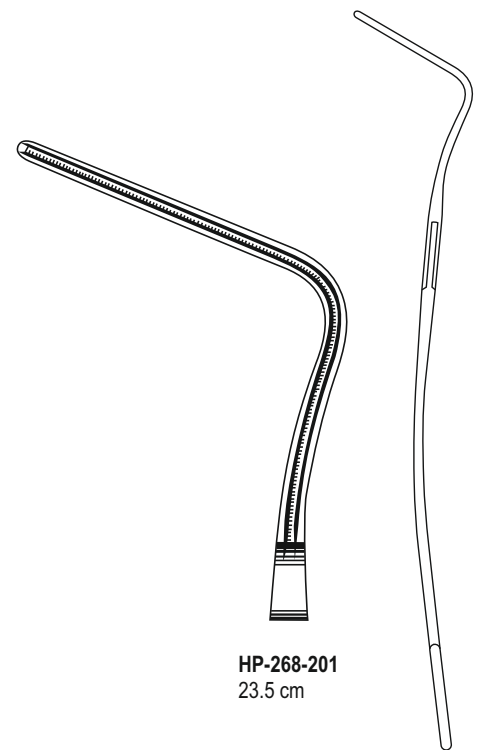
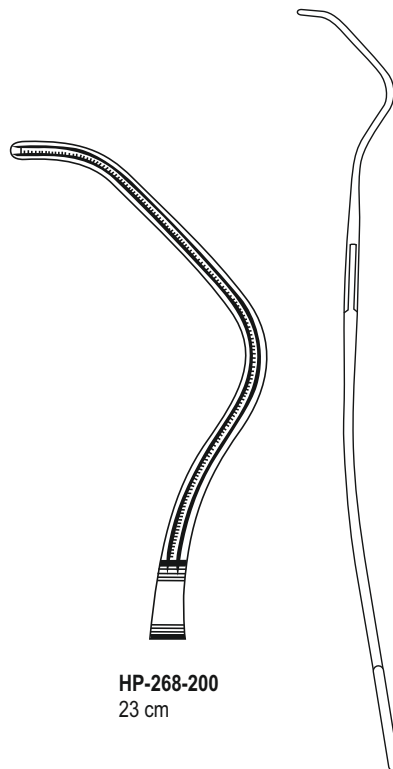
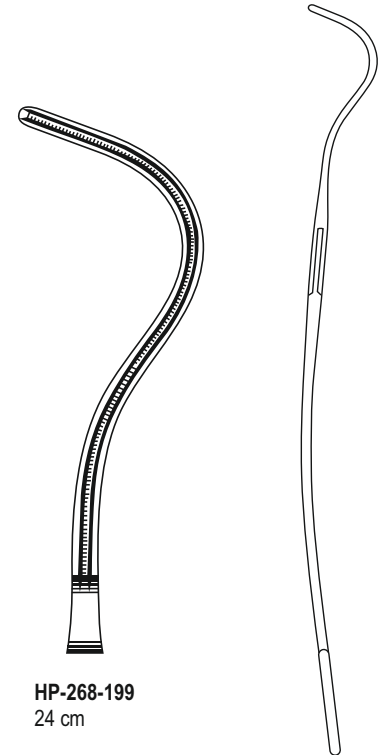
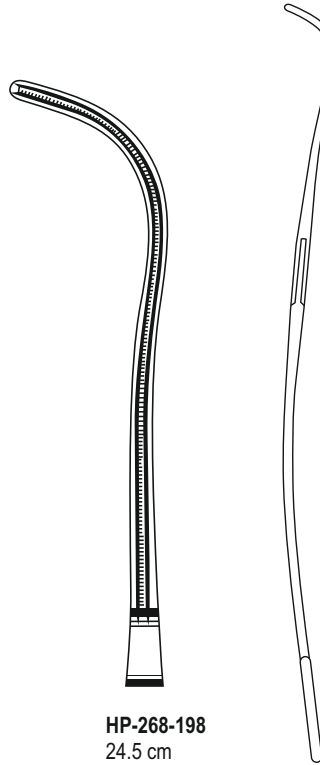

Aorta-Anastomosis Clamps, Anastomosis Clamps

Aorta-Anastomose-Klemmen, Anastomose-Klemmen
Braçadeiras Anastomose Aorta, Anastomose Braçadeiras
Abrazaderas de aorta-anastomosis, abrazaderas de anastomosis

ATRAUMA



1/2
LambeHP-Kay
HP-269-267 - HP-269-268
20.5 cm
Aorta-Anastomosis clamp

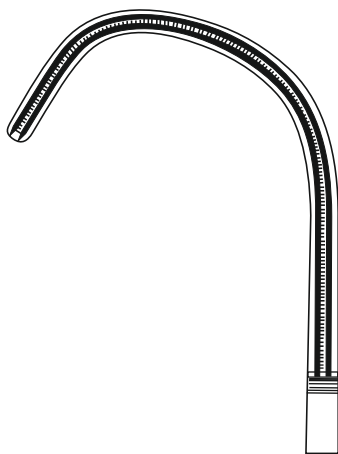
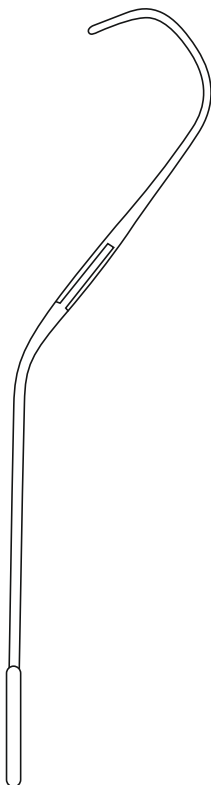

HP-269-201
22.5 cm

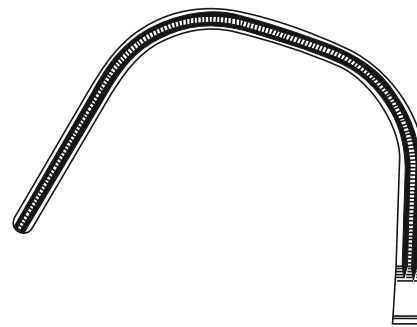

HP-269-202
20.5 cm

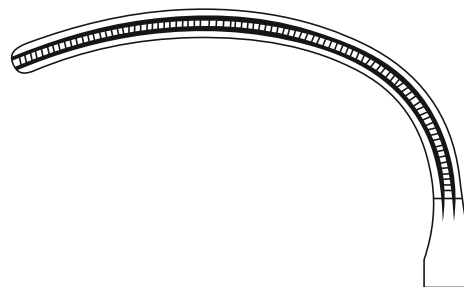

HP-269-204
22 cm

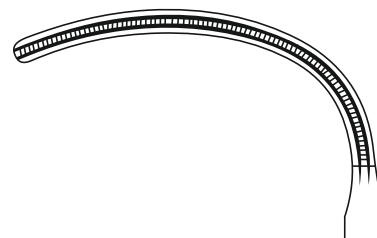

HP-269-205
18 cm



1/2
DeBakey
HP-269-203
16.5 cm
Aorta-Anastomosis clamp

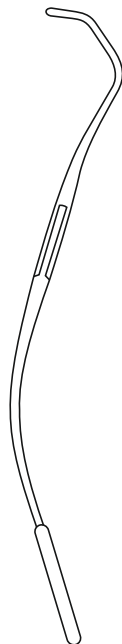

1/2
Glover
HP-269-204 - HP-269-205
18 cm
Anastomosis clamp

ATRAUMA



Haemostatic Forceps
Hämostatische Pinzetten
Pinça hemostática
Pinzas hemostáticas

ATRAUMA



HP-271-210
12.5 cm
Straight



HP-271-211
12.5 cm
Curved

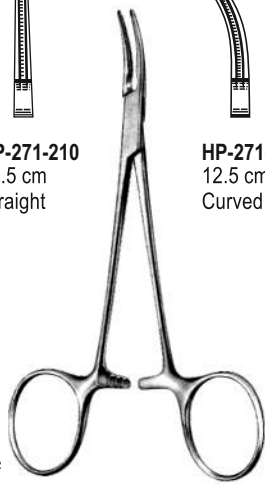

1/2

DeBakey-Mosquito
HP-271-210 - CS-495-211

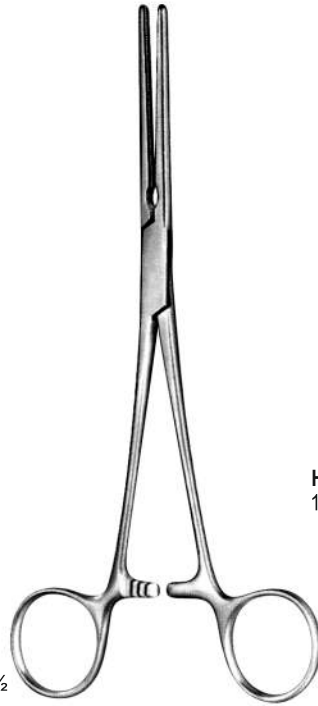

1/2

DeBakey-Pean
HP-271-212 - HP-271-215
18.5 cm



HP-271-212
14.5 cm

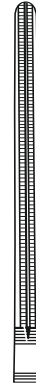

HP-271-213
16.5 cm



HP-271-214
18.5 cm

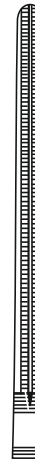

HP-271-215
20.5 cm



1/2

DeBakey-Pean
HP-271-216 - HP-271-219
18.5 cm



HP-271-216
14.5 cm

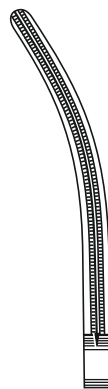

HP-271-217
16.5 cm



HP-271-218
18.5 cm

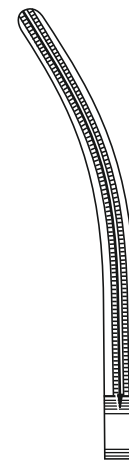

HP-271-219
20.5 cm

ATRAUMA



DeBakey
 HP-272-220
 15 cm



DeBakey
 HP-272-221
 16.5 cm

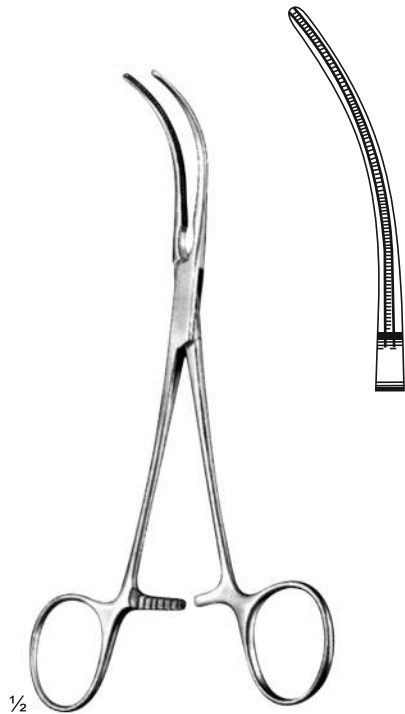

Glover
 HP-272-222
 17 cm

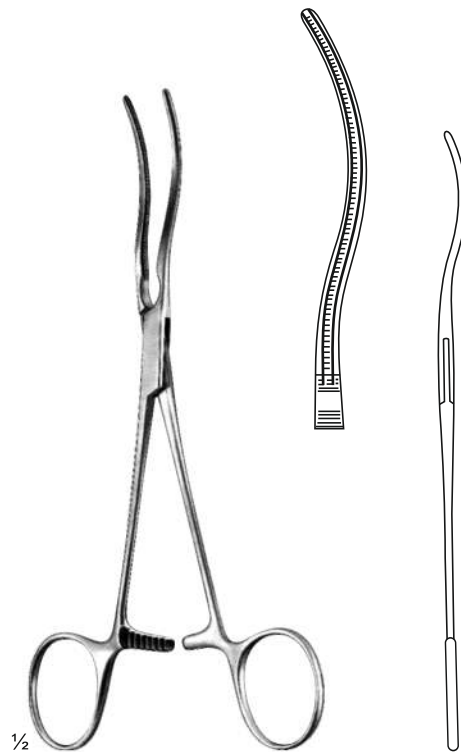

Glover
 HP-272-223
 17.5 cm

Anastomosis Clamps
Anastomoseshellen
Grampos Anastomose
Abrazaderas de anastomosis

ATRAUMA

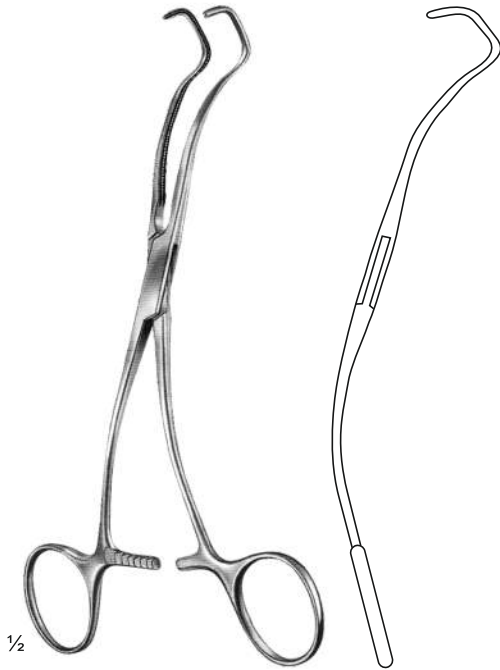

Derra
HP-273-224 - CS-499-226
17.5 cm

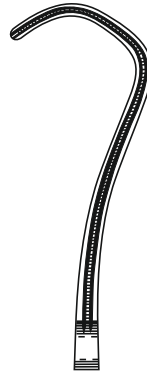

Fig. 1
HP-273-224
16.5 cm



Fig. 2
HP-273-225
17 cm

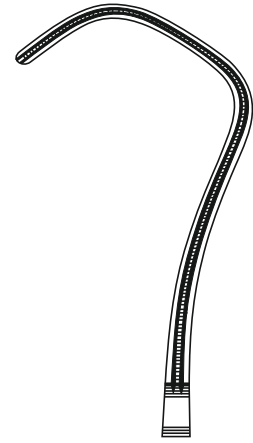

Fig. 3
HP-273-226
17.5 cm



DeBakey-Beck
HP-273-227
17 cm

Anastomosis Clamps, Multi Purpose Vascular Clamps

Anastomosenklemmen, Mehrzweck-Gefäßklemmen
 Braçadeiras Anastomose, Braçadeiras Vasculares Multifuncionais
 Abrazaderas de anastomosis, abrazaderas vasculares multiuso

ATRAUMA

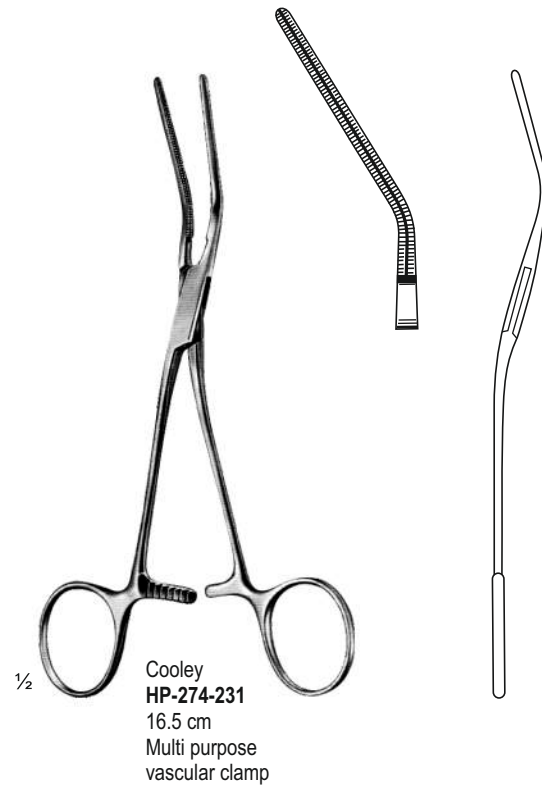
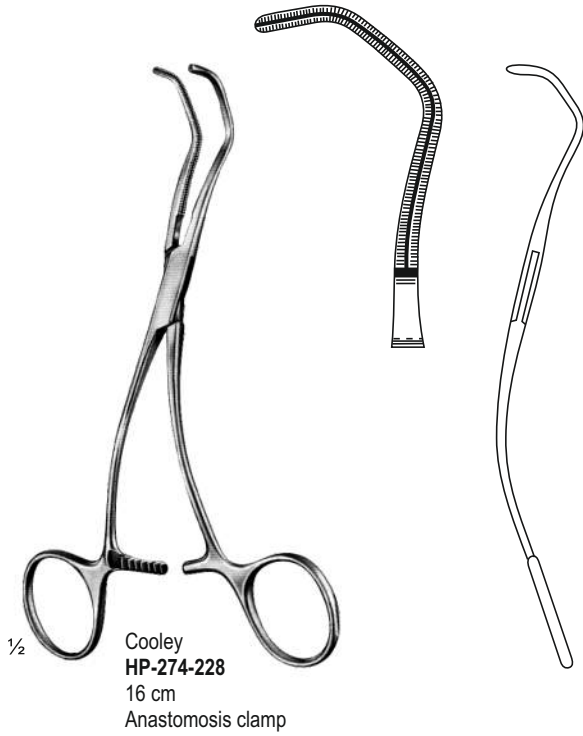



Neurosurgery, Laminectomy

Neurochirurgie, Laminektomie

Neurocirurgia, Laminectomia

Neurocirugía, laminectomía

Page 276-330

Wire Saws
Sierras de alambre
Serras De Ar

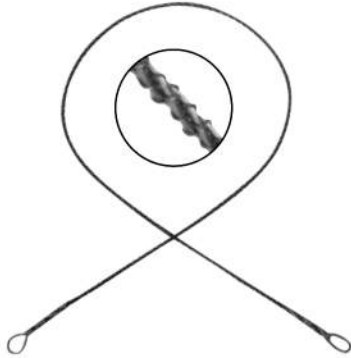

Gigli
HP-276-001 - HP-276-005

HP-276-001
30 cm

HP-276-002
40 cm

HP-276-003
50 cm

HP-276-004
60 cm

HP-276-005
70 cm

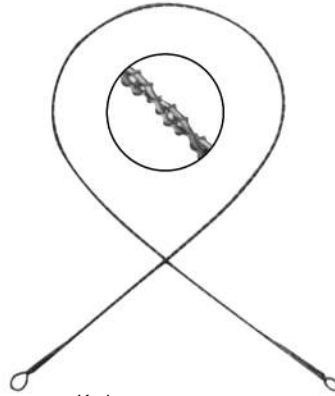

Karison
HP-276-006 - HP-276-010

HP-276-006
30 cm

HP-276-007
40 cm

HP-276-008
50 cm

HP-276-009
60 cm

HP-276-010
70 cm



1/4
Gigli
HP-276-011
Wire saw handle



1/2
Lebsche
HP-276-012
25 cm
Wire saw guide
malleabl



Gigli
HP-276-013 - HP-276-014
30.5 cm
Introducer guide

HP-276-013
5 mm
HP-276-014
7 mm



1/2
De Martel
HP-276-015
33 cm
Wire saw guide



HP-277-016
7 cm
Drill Point
3.5 mm ø



HP-277-017
7 cm
Drill Point
5 mm ø



Crutchfield
HP-277-016 - HP-277-017
Small pattern



Crutchfield
HP-277-018
Medium pattern



HP-277-019
Large pattern
and spare pin



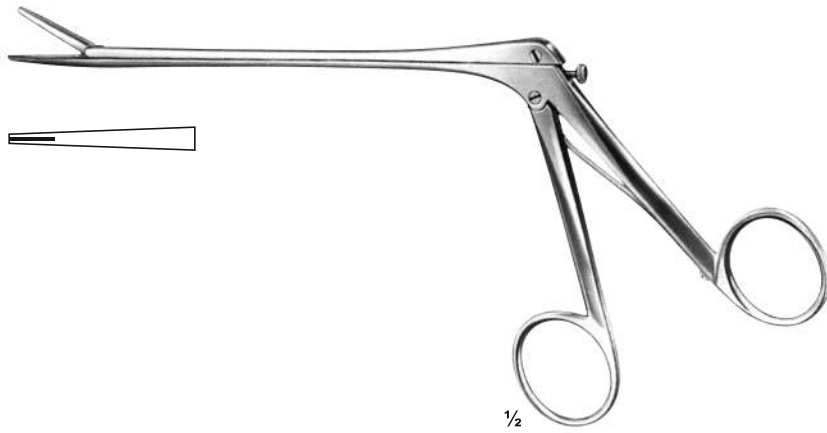

Olivecrona-Toennis
HP-279-024
Clip applying forceps



Mckenzie
HP-279-025
18.5 cm
Clip applying forceps



Kölner
HP-279-026
Scalp Clip



Raney
HP-279-027
Scalp Clip



Raney
HP-279-028
15.5 cm
Applying/Removal forceps

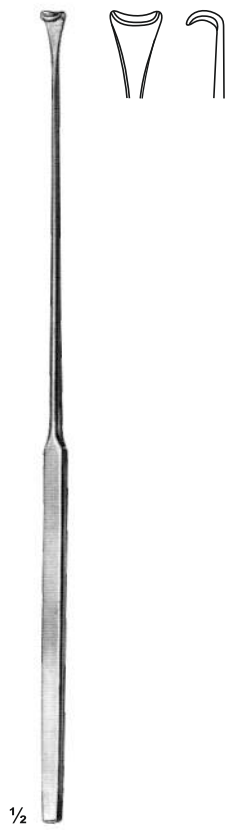

Fig. 1
Love
HP-280-029
21.5 cm



Fig. 2
Love
HP-280-030
17.5 cm

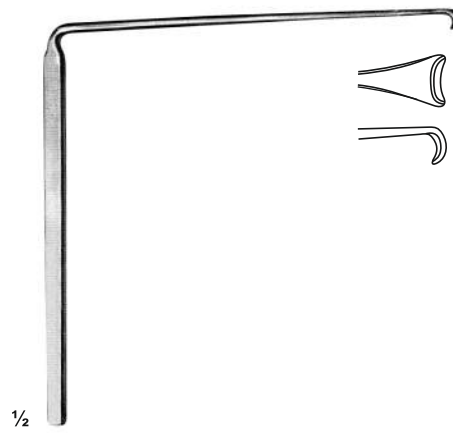

Fig. 3
Love
HP-280-031
11 cm



Love
HP-280-032
21 cm

Leyla Retractors System

Leyla Retraktorsystem
Sistema de Retratores Leyla
Sistema de retractores Leyla



Leyla
HP-281-033
Self-Retaining Retractor
for fixation to operating table, complete,
consisting out of:

Leyla Retractors System

Leyla Retractorsystem
Sistema de Retratores Leyla
Sistema de retractoros Leyla



HP-282-034
Ball and Socket Joint
for fixation of holding rod
at the operating table



HP-282-035
Holding Rod, detachable,
for fixation in ball and socket joint
and to hold a desired coupling head

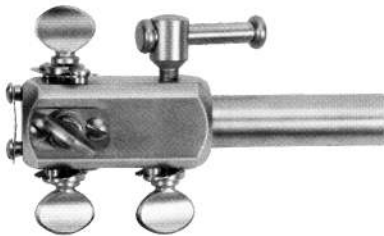

HP-282-036
Coupling Head
to hold 5 flexible arms



HP-282-037
Coupling Head, turnable,
to hold 1 flexible arm



Yasargil
HP-282-039
Brain Retractor, flexible, for 1 flat
spatula, complete, consisting out of:

Yasargil
HP-282-040
Brain Retractor, flexible, for 2 flat
spatula, complete, consisting out of:

HP-282-038
Coupling Head, lateral open,
to hold 1 flexible arm

Leyla Retractors System

Leyla Retraktorsystem
Sistema de Retratores Leyla
Sistema de retractores Leyla



Yasargil
HP-283-041
Flexible arms, only



Yasargil
HP-283-042
Ear Specula Holder, complete, consisting out of:



HP-283-043
Support for flat
brain spatula



HP-283-044
Support for brain
spatula with round shaf



HP-283-045
Fixation Base for skull mounting,
holding 2 flexible arms

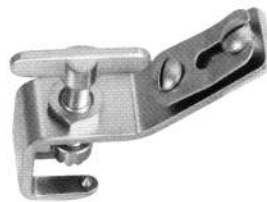

HP-283-046
Fixation Base for skull mounting,
holding 1 flexible arm



HP-283-047
Fixation Base for mounting on bars
up to Ø 16 mm, for 1 flexible arm

Nerve Root Retractors
Nervenwurzel-Reraktoren
Retradores da Raiz Nervosa
Retradores de la raíz nerviosa



HP-284-048
3 mm

HP-284-049
5 mm

HP-284-050
7 mm

Hess
HP-284-048 - HP-284-050
17.5 cm

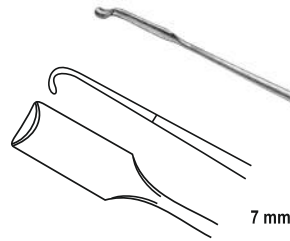

Scoville
HP-284-051
16.5 cm

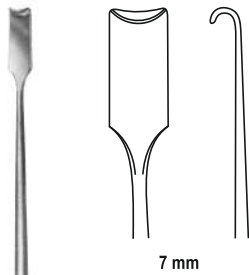

Scoville
HP-284-052
23.5 cm

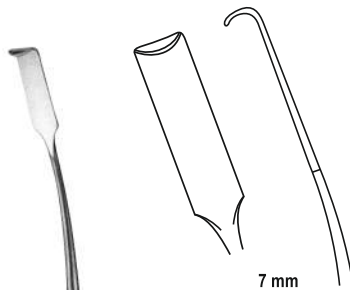

Holsher
HP-284-053
24 cm



HP-284-054
6 mm

HP-284-055
8 mm

HP-284-056
10 mm

Caspar
HP-284-054 - HP-284-056
24.5 cm



Yasargil
HP-285-057
19 cm

Yasargil
HP-285-058
19 cm

Yasargil
HP-285-059
19 cm

Yasargil
HP-285-060
19 cm

Yasargil
HP-285-061
19 cm

Yasargil
HP-285-062
19 cm

Jacobson
HP-285-063
19 cm



Jacobson
HP-285-064
19 cm

Yasargil
HP-285-065
19 cm

HP-285-066
19 cm

HP-285-067
19 cm

Yasargil

HP-285-068
19 cm

HP-285-069
19 cm

Yasargil
HP-285-057 -
HP-285-069
19 cm

Nerve and Dura Hooks
Nerven- und Dura-Haken
Nervo e Ganchos Dura
Nervio y Dura Hooks



Smithwick
HP-286-070
29 cm
Dura Dissector



Smithwick
HP-286-071 - HP-286-272
Nerve hook



HP-286-071
17 cm



HP-286-072
21 cm



Hoen
HP-286-073
22 cm
11 mm



Dandy
HP-286-074
20 cm
4.0 mm



Dandy
HP-286-075
20 cm
4.0 mm



Dandy
HP-286-076
20 cm
4.0 mm



HP-287-077
20 cm

HP-287-078
23 cm



HP-287-079
16.5 cm

HP-287-080
18.5 cm



Sachs
HP-287-081
17 cm

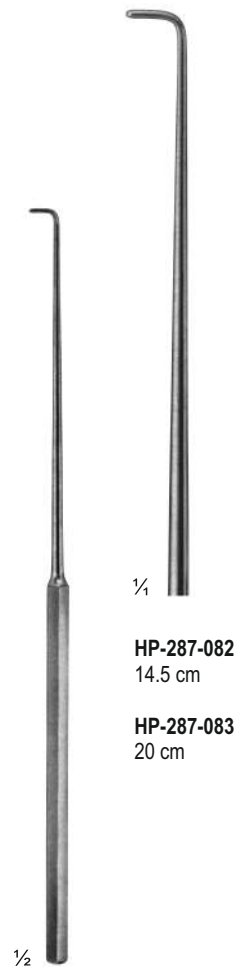

HP-287-082
14.5 cm

HP-287-083
20 cm

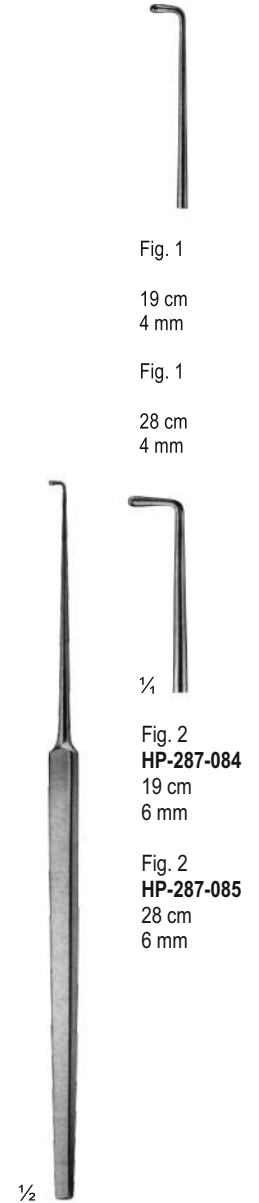

Fig. 1
19 cm
4 mm

Fig. 1
28 cm
4 mm

Fig. 2
HP-287-084
19 cm
6 mm

Fig. 2
HP-287-085
28 cm
6 mm

Adson
HP-287-077 - HP-287-078

Graham
HP-287-079 - HP-287-080

Crile
HP-287-082 - HP-287-083

Cushing
HP-287-084 - HP-287-085



½

Blalock
HP-288-086
23 cm



½

PBI
HP-288-087
19 cm
with ball



½

PBI
HP-288-088
19 cm



½

Adson
HP-288-089
20 cm
7 mm



Sharp



½

Adson
HP-288-090
20 cm
7 mm



Blunt



½

Sachs
HP-288-091
20 cm
7 mm

Sharp

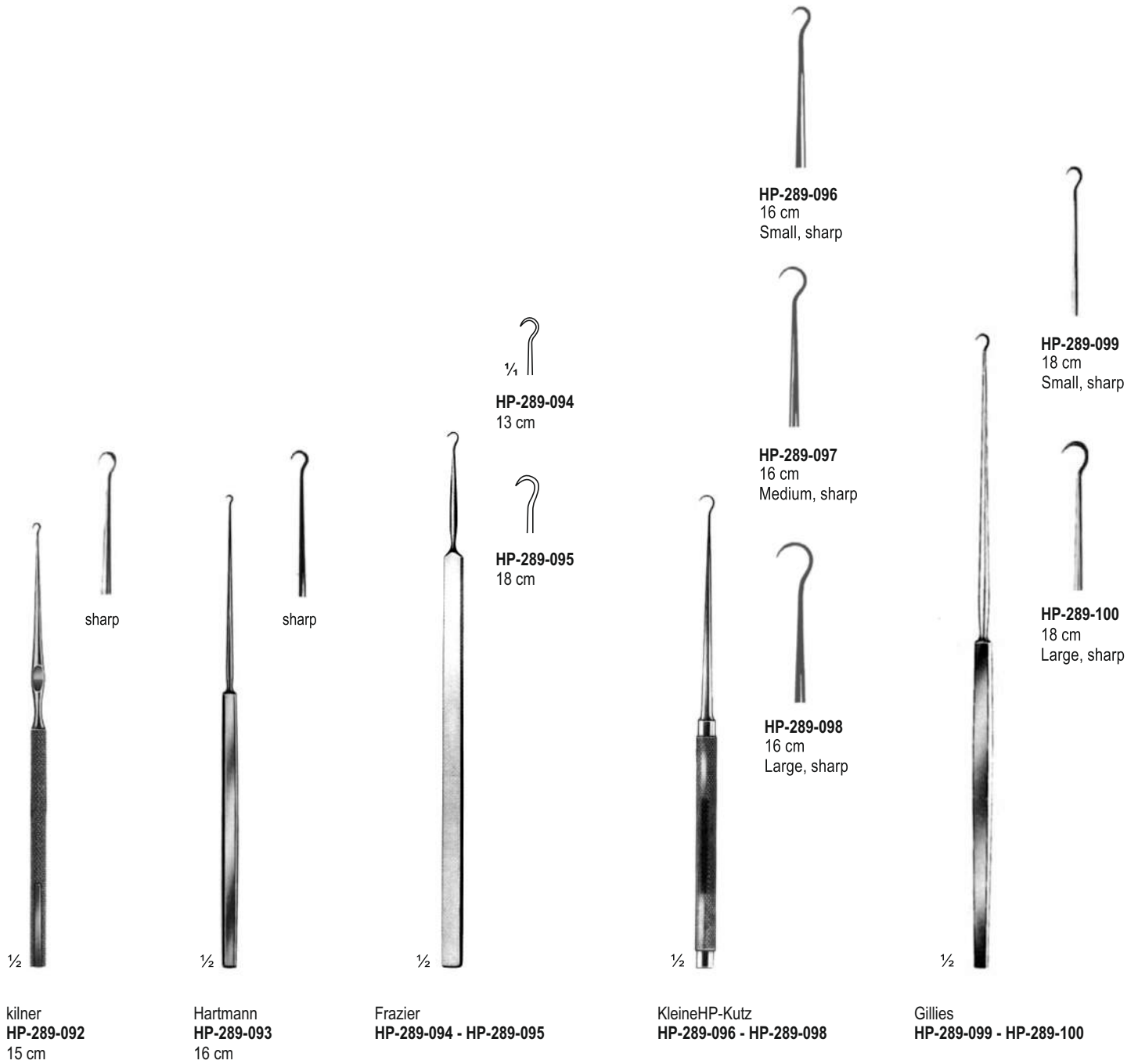



HP-290-101
30 cm

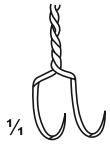

HP-290-102
41 cm

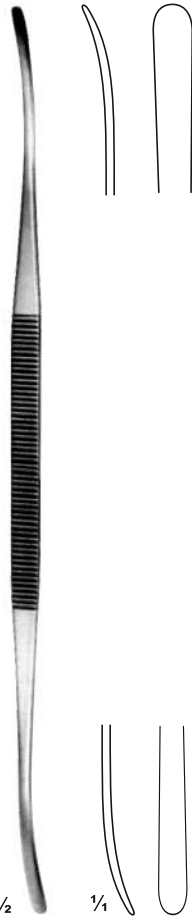

Yasargil
HP-290-101 - HP-290-102
Galea hook

Toennis
HP-290-103
24 cm
Dura dissectors



Davis
HP-290-104
21.5 cm
Dura dissectors
sharp



Davis
HP-290-105
24.5 cm
Dura dissectors

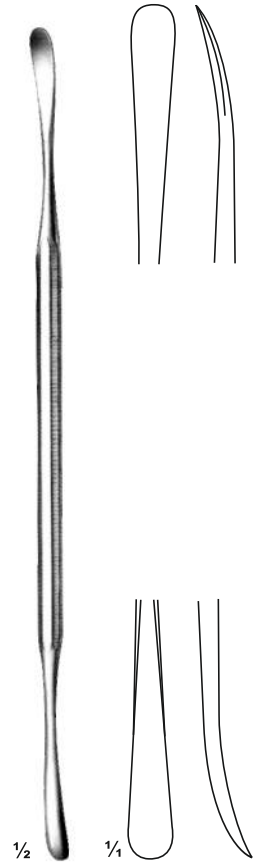

HP-290-106
22 cm



Freer
HP-291-107
 18 cm
 Septum elevator

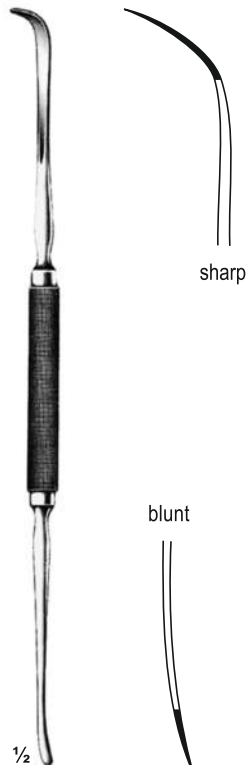

Freer
HP-291-108
 20 cm
 Septum elevator



Micro Dissector
HP-291-109 - HP-291-110
HP-291-109 18.5 cm
HP-291-110 21.5 cm



Dorsey
HP-291-111
 16.5 cm
 17 mm/5 mm
 Dura Separator

Lamina Spreaders

Lamina-Spreizer
Espalhadores de lamina
Esparcidosores de Lamina



Cloward
HP-292-112
15.5 cm

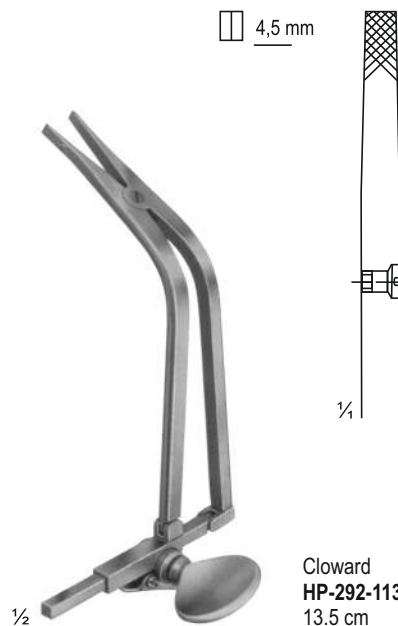

Cloward
HP-292-113
13.5 cm

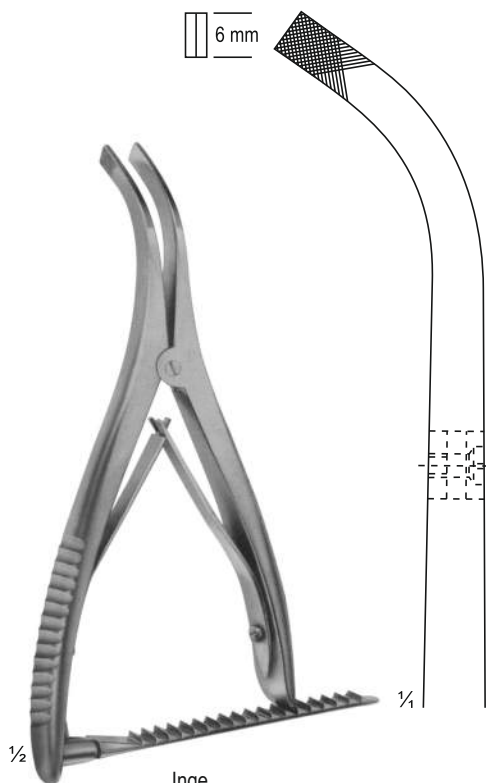

Inge
HP-292-114
17 cm

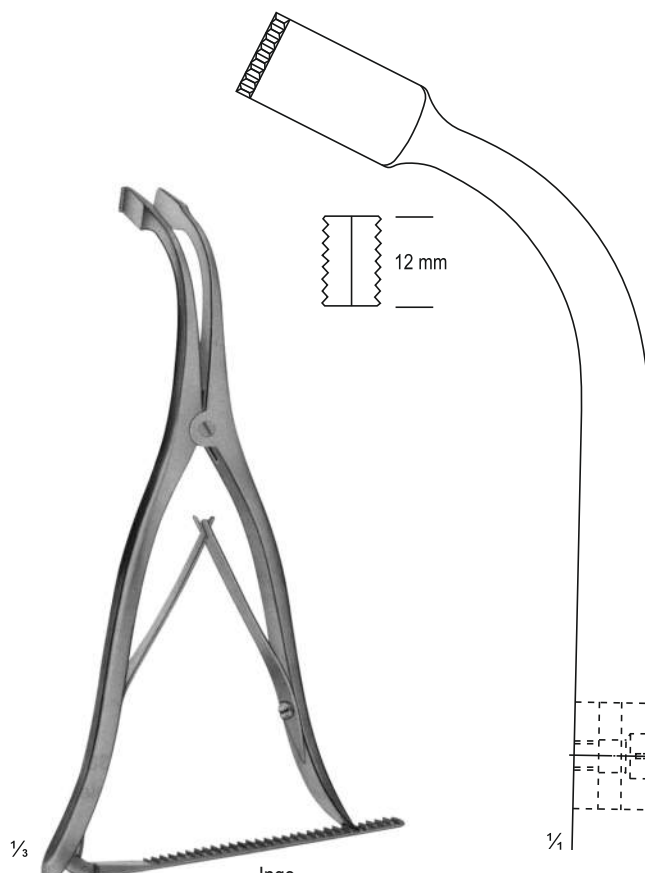

Inge
HP-292-115 - HP-292-116
HP-292-115 16.5 cm
HP-292-116 27.5 cm

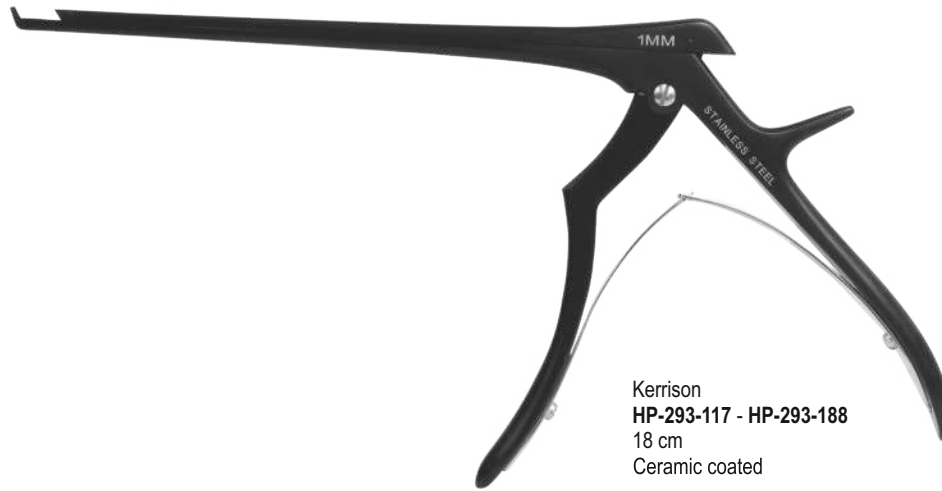

Kerrison
HP-293-117 - HP-293-188
18 cm
Ceramic coated



Up	Length of shaft 180 mm	Length of shaft 200 mm	Length of shaft 230 mm		Length of shaft 180 mm	Length of shaft 200 mm	Length of shaft 230 mm
	HP-293-117	HP-293-123	HP-293-129		HP-293-135	HP-293-141	HP-293-147
	HP-293-118	HP-293-124	HP-293-130		HP-293-136	HP-293-142	HP-293-148
	HP-293-119	HP-293-125	HP-293-131		HP-293-137	HP-293-143	HP-293-149
	HP-293-120	HP-293-126	HP-293-132		HP-293-138	HP-293-144	HP-293-150
	HP-293-121	HP-293-127	HP-293-133		HP-293-139	HP-293-145	HP-293-151
	HP-293-122	HP-293-128	HP-293-134		HP-293-140	HP-293-146	HP-293-152



Down	Length of shaft 180 mm	Length of shaft 200 mm	Length of shaft 230 mm		Length of shaft 180 mm	Length of shaft 200 mm	Length of shaft 230 mm
	HP-293-153	HP-293-159	HP-293-165		HP-293-171	HP-293-177	HP-293-183
	HP-293-154	HP-293-160	HP-293-166		HP-293-172	HP-293-178	HP-293-184
	HP-293-155	HP-293-161	HP-293-167		HP-293-173	HP-293-179	HP-293-185
	HP-293-156	HP-293-162	HP-293-168		HP-293-174	HP-293-180	HP-293-186
	HP-293-157	HP-293-163	HP-293-169		HP-293-175	HP-293-181	HP-293-187
	HP-293-158	HP-293-164	HP-293-170		HP-293-176	HP-293-182	HP-293-188

All sizes are also available in thin footplate

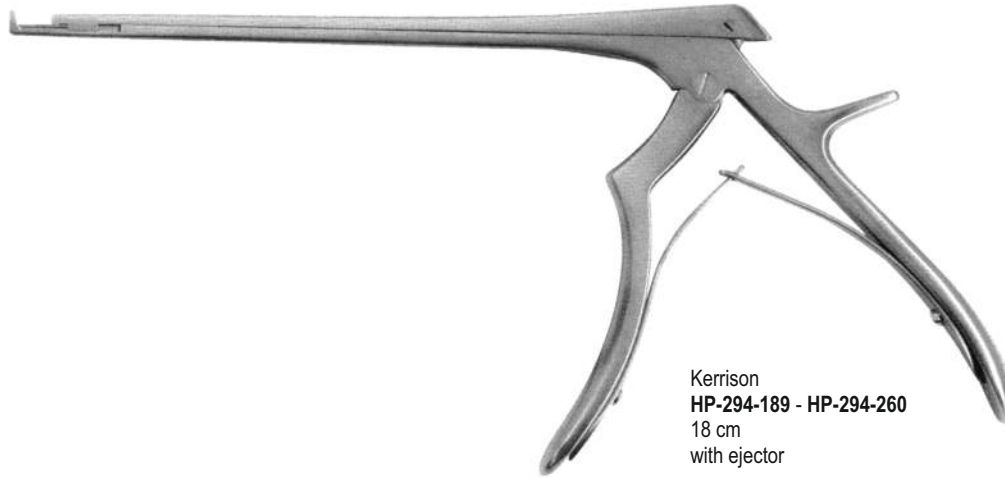

Kerrison
HP-294-189 - HP-294-260
18 cm
with ejector

90°



40°



Up

	Length of shaft 180 mm	Length of shaft 200 mm	Length of shaft 230 mm
1 mm	HP-294-189	HP-294-195	HP-294-201
2 mm	HP-294-190	HP-294-196	HP-294-202
3 mm	HP-294-191	HP-294-197	HP-294-203
4 mm	HP-294-192	HP-294-198	HP-294-204
5 mm	HP-294-193	HP-294-199	HP-294-205
6 mm	HP-294-194	HP-294-200	HP-294-206

	Length of shaft 180 mm	Length of shaft 200 mm	Length of shaft 230 mm
1 mm	HP-294-207	HP-294-213	HP-294-219
2 mm	HP-294-208	HP-294-214	HP-294-220
3 mm	HP-294-209	HP-294-215	HP-294-221
4 mm	HP-294-210	HP-294-216	HP-294-222
5 mm	HP-294-211	HP-294-217	HP-294-223
6 mm	HP-294-212	HP-294-218	HP-294-224

90°



40°



Down

	Length of shaft 180 mm	Length of shaft 200 mm	Length of shaft 230 mm
1 mm	HP-294-225	HP-294-231	HP-294-237
2 mm	HP-294-226	HP-294-232	HP-294-238
3 mm	HP-294-227	HP-294-233	HP-294-239
4 mm	HP-294-228	HP-294-234	HP-294-240
5 mm	HP-294-229	HP-294-235	HP-294-241
6 mm	HP-294-230	HP-294-236	HP-294-242

	Length of shaft 180 mm	Length of shaft 200 mm	Length of shaft 230 mm
1 mm	HP-294-243	HP-294-249	HP-294-255
2 mm	HP-294-244	HP-294-250	HP-294-256
3 mm	HP-294-245	HP-294-251	HP-294-257
4 mm	HP-294-246	HP-294-252	HP-294-258
5 mm	HP-294-247	HP-294-253	HP-294-259
6 mm	HP-294-248	HP-294-254	HP-294-260

All sizes are also available in thin footplate and black coating

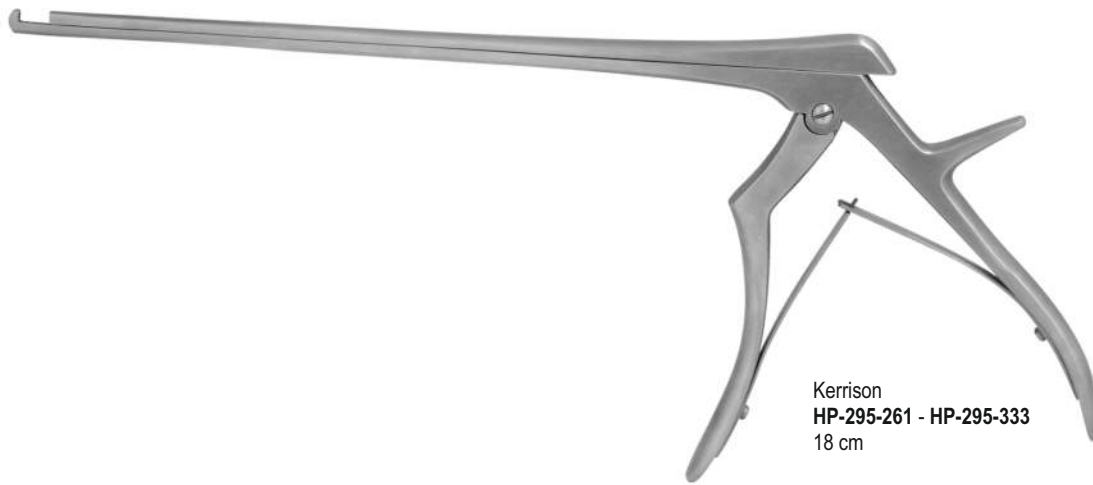







90°









40°



Up

	Length of shaft 180 mm	Length of shaft 200 mm	Length of shaft 230 mm
 1 mm	HP-295-261	HP-295-267	HP-295-273
 2 mm	HP-295-262	HP-295-268	HP-295-274
 3 mm	HP-295-263	HP-295-269	HP-295-275
 4 mm	HP-295-264	HP-295-270	HP-295-276
 5 mm	HP-295-265	HP-295-271	HP-295-277
 6 mm	HP-295-266	HP-295-272	HP-295-278

	Length of shaft 180 mm	Length of shaft 200 mm	Length of shaft 230 mm
 1 mm	HP-295-279	HP-295-285	HP-295-291
 2 mm	HP-295-280	HP-295-286	HP-295-292
 3 mm	HP-295-281	HP-295-287	HP-295-294
 4 mm	HP-295-282	HP-295-288	HP-295-295
 5 mm	HP-295-283	HP-295-289	HP-295-596
 6 mm	HP-295-284	HP-295-290	HP-295-297







90°









40°



Down

	Length of shaft 180 mm	Length of shaft 200 mm	Length of shaft 230 mm
 1 mm	HP-295-298	HP-295-304	HP-295-310
 2 mm	HP-295-299	HP-295-305	HP-295-311
 3 mm	HP-295-300	HP-295-306	HP-295-312
 4 mm	HP-295-301	HP-295-307	HP-295-313
 5 mm	HP-295-302	HP-295-308	HP-295-314
 6 mm	HP-295-303	HP-295-309	HP-295-315

	Length of shaft 180 mm	Length of shaft 200 mm	Length of shaft 230 mm
 1 mm	HP-295-316	HP-295-322	HP-295-328
 2 mm	HP-295-317	HP-295-323	HP-295-329
 3 mm	HP-295-318	HP-295-324	HP-295-330
 4 mm	HP-295-319	HP-295-325	HP-295-331
 5 mm	HP-295-320	HP-295-326	HP-295-332
 6 mm	HP-295-321	HP-295-327	HP-295-333

All sizes are also available in thin footplate



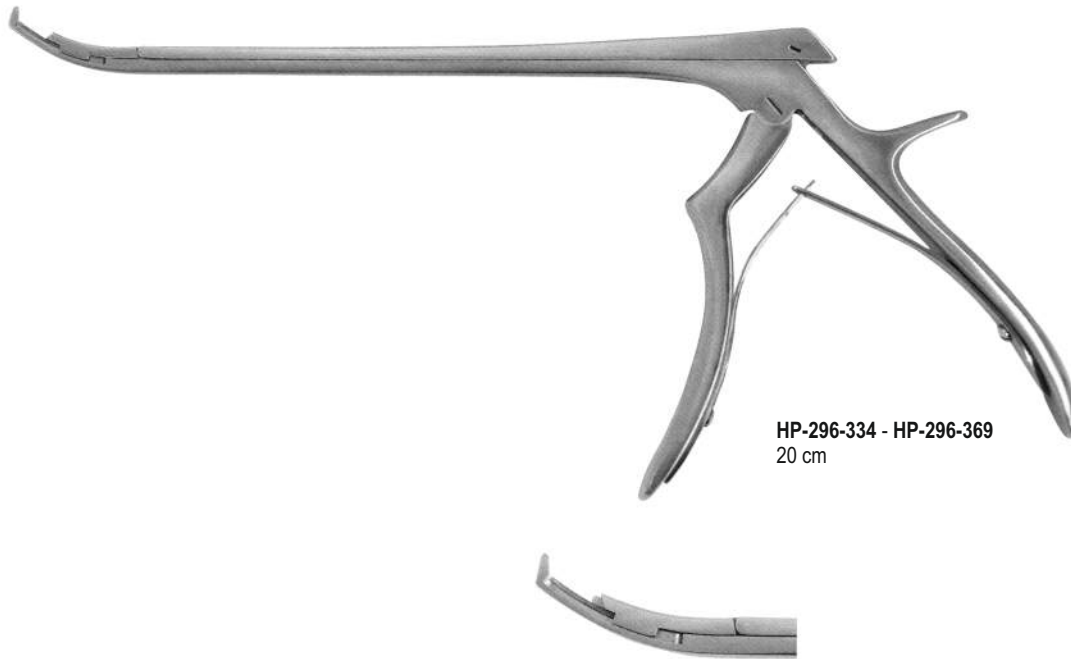

Laminectomy Punches

Laminektomie Stanzen
Socos de laminectomia
Punzones de laminectomía







HP-296-334 - HP-296-369
20 cm

Up

-  1 mm, 130° (40°)
-  2 mm, 130° (40°)
-  3 mm, 130° (40°)
-  4 mm, 130° (40°)
-  5 mm, 130° (40°)
-  6 mm, 130° (40°)

Length of shaft 180 mm	Length of shaft 200 mm	Length of shaft 230 mm	Foraminotomy Punches
HP-296-334	HP-296-340	HP-296-346	with ejector
HP-296-335	HP-296-341	HP-296-347	with ejector
HP-296-336	HP-296-342	HP-296-348	with ejector
HP-296-337	HP-296-343	HP-296-349	with ejector
HP-296-338	HP-296-344	HP-296-350	with ejector
HP-296-339	HP-296-345	HP-296-351	with ejector

Down

-  1 mm, 130° (40°)
-  2 mm, 130° (40°)
-  3 mm, 130° (40°)
-  4 mm, 130° (40°)
-  5 mm, 130° (40°)
-  6 mm, 130° (40°)

Length of shaft 180 mm	Length of shaft 200 mm	Length of shaft 230 mm	Foraminotomy Punches
HP-296-352	HP-296-358	HP-296-364	with ejector
HP-296-353	HP-296-359	HP-296-365	with ejector
HP-296-354	HP-296-360	HP-296-366	with ejector
HP-296-355	HP-296-361	HP-296-367	with ejector
HP-296-356	HP-296-362	HP-296-368	with ejector
HP-296-357	HP-296-363	HP-296-369	with ejector

All sizes are also available in thin footplate and black coating





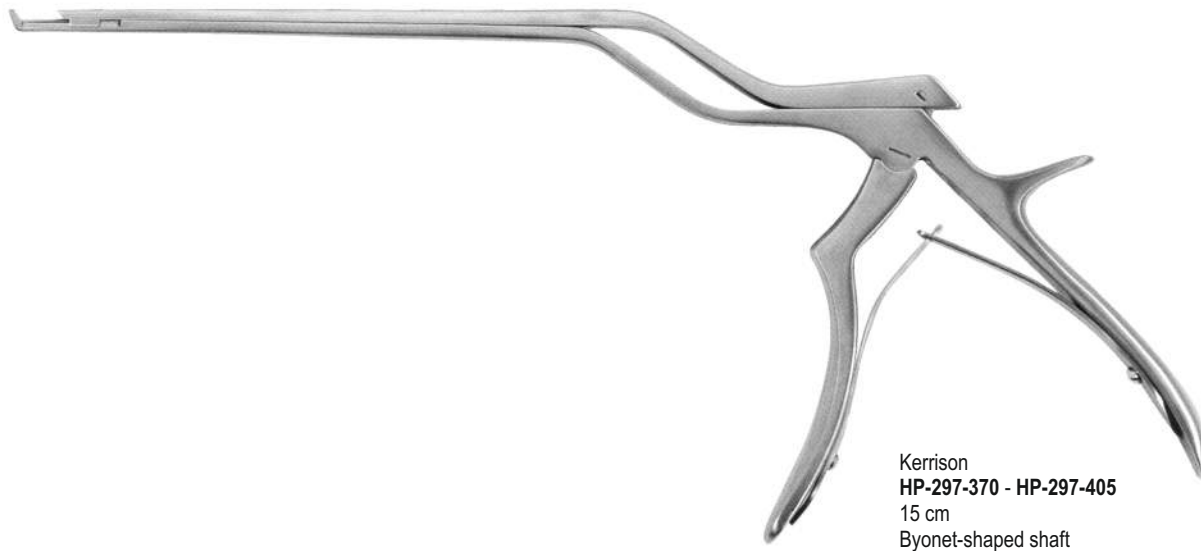

Laminectomy Punches

Laminektomie Stanzen
Socos de laminectomia
Punzones de laminectomia





Kerrison
HP-297-370 - HP-297-405
15 cm
Byonet-shaped shaft

Up

-  1 mm, 90°
-  2 mm, 90°
-  3 mm, 90°
-  4 mm, 90°
-  5 mm, 90°
-  6 mm, 90°

Length of shaft 180 mm	Length of shaft 200 mm	Length of shaft 230 mm	Foraminotomy Punches
HP-297-370	HP-297-376	HP-297-382	with ejector
HP-297-371	HP-297-377	HP-297-383	with ejector
HP-297-372	HP-297-378	HP-297-384	with ejector
HP-297-373	HP-297-379	HP-297-385	with ejector
HP-297-374	HP-297-380	HP-297-386	with ejector
HP-297-375	HP-297-381	HP-297-387	with ejector

Down

-  1 mm, 130° (40°)
-  2 mm, 130° (40°)
-  3 mm, 130° (40°)
-  4 mm, 130° (40°)
-  5 mm, 130° (40°)
-  6 mm, 130° (40°)

Length of shaft 180 mm	Length of shaft 200 mm	Length of shaft 230 mm	Foraminotomy Punches
HP-297-388	HP-297-394	HP-297-400	with ejector
HP-297-389	HP-297-395	HP-297-401	with ejector
HP-297-390	HP-297-396	HP-297-402	with ejector
HP-297-391	HP-297-397	HP-297-403	with ejector
HP-297-392	HP-297-398	HP-297-404	with ejector
HP-297-393	HP-297-399	HP-297-405	with ejector

All sizes are also available in thin footplate and black coating

Laminectomy Punches

Laminektomie Stanzen
Socos de laminectomia
Punzones de laminectomía

14

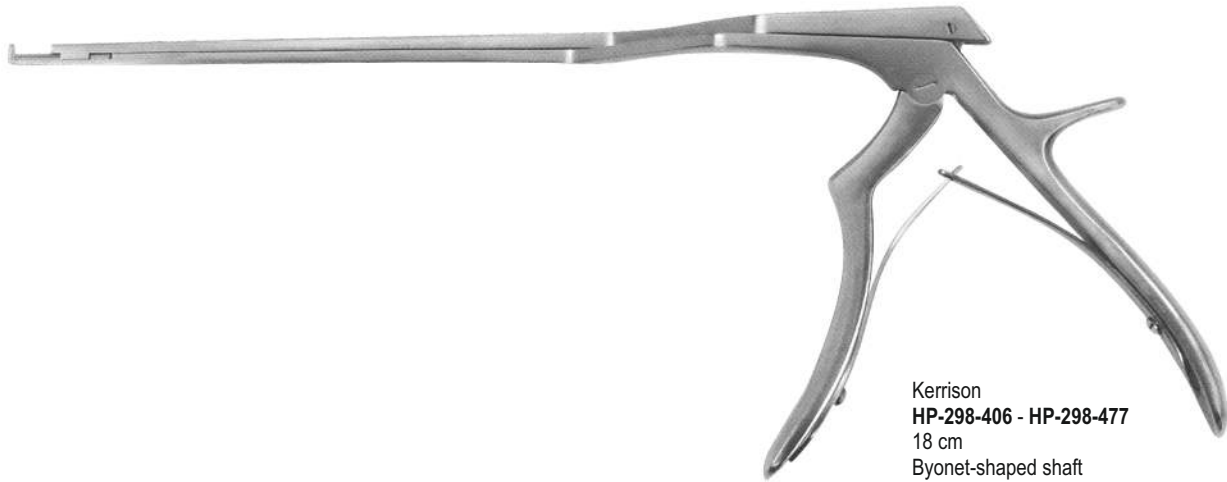

90°



130° (40°)



Up

- △ 1 mm
- △ 2 mm
- △ 3 mm
- △ 4 mm
- △ 5 mm
- △ 6 mm

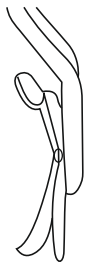

Bayonet left

Length of shaft 110 mm	Length of shaft 150 mm	Length of shaft 180 mm	Length of shaft 110 mm	Length of shaft 150 mm	Length of shaft 180 mm
HP-298-406	HP-298-412	HP-298-418	HP-298-424	HP-298-430	HP-298-436
HP-298-407	HP-298-413	HP-298-419	HP-298-425	HP-298-431	HP-298-437
HP-298-408	HP-298-414	HP-298-420	HP-298-426	HP-298-432	HP-298-438
HP-298-409	HP-298-415	HP-298-421	HP-298-427	HP-298-433	HP-298-439
HP-298-410	HP-298-416	HP-298-422	HP-298-428	HP-298-434	HP-298-440
HP-298-411	HP-298-417	HP-298-423	HP-298-429	HP-298-435	HP-298-441

90°



130° (40°)



Down

- ▽ 1 mm
- ▽ 2 mm
- ▽ 3 mm
- ▽ 4 mm
- ▽ 5 mm
- ▽ 6 mm

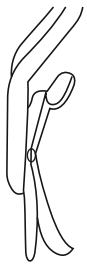

Bayonet right

Length of shaft 110 mm	Length of shaft 150 mm	Length of shaft 180 mm	Length of shaft 110 mm	Length of shaft 150 mm	Length of shaft 180 mm
HP-298-442	HP-298-448	HP-298-454	HP-298-460	HP-298-466	HP-298-472
HP-298-443	HP-298-449	HP-298-455	HP-298-461	HP-298-467	HP-298-473
HP-298-444	HP-298-450	HP-298-456	HP-298-462	HP-298-468	HP-298-474
HP-298-445	HP-298-451	HP-298-457	HP-298-463	HP-298-469	HP-298-475
HP-298-446	HP-298-452	HP-298-458	HP-298-464	HP-298-470	HP-298-476
HP-298-447	HP-298-453	HP-298-459	HP-298-465	HP-298-471	HP-298-477

All sizes are also available in thin footplate and black coating

Laminectomy Punches

Laminektomie Stanzen
Socos de laminectomia
Punzones de laminectomia



Kerrison
HP-299-478 - HP-299-513
18 cm
Detachable



45°

Up		Length of shaft 180 mm	Length of shaft 200 mm	Length of shaft 230 mm
	1 mm	HP-299-478	HP-299-484	HP-299-490
	2 mm	HP-299-479	HP-299-485	HP-299-491
	3 mm	HP-299-480	HP-299-486	HP-299-492
	4 mm	HP-299-481	HP-299-487	HP-299-493
	5 mm	HP-299-482	HP-299-488	HP-299-494
	6 mm	HP-299-483	HP-299-489	HP-299-495



90°

Up		Length of shaft 180 mm	Length of shaft 200 mm	Length of shaft 230 mm
	1 mm	HP-299-496	HP-299-502	HP-299-508
	2 mm	HP-299-497	HP-299-503	HP-299-509
	3 mm	HP-299-498	HP-299-504	HP-299-510
	4 mm	HP-299-499	HP-299-505	HP-299-511
	5 mm	HP-299-500	HP-299-506	HP-299-512
	6 mm	HP-299-501	HP-299-507	HP-299-513

All sizes are also available in thin footplate

Laminectomy Punches

Laminektomie Stanzen
Socos de laminectomia
Punzones de laminectomía



45°



Up		Length of shaft 180 mm	Length of shaft 200 mm	Length of shaft 230 mm
	1 mm	HP-300-514	HP-300-520	HP-300-526
	2 mm	HP-300-515	HP-300-521	HP-300-527
	3 mm	HP-300-516	HP-300-522	HP-300-528
	4 mm	HP-300-517	HP-300-523	HP-300-529
	5 mm	HP-300-518	HP-300-524	HP-300-530
	6 mm	HP-300-519	HP-300-525	HP-300-531

90°



Up		Length of shaft 180 mm	Length of shaft 200 mm	Length of shaft 230 mm
	1 mm	HP-300-532	HP-300-538	HP-300-544
	2 mm	HP-300-533	HP-300-539	HP-300-545
	3 mm	HP-300-534	HP-300-540	HP-300-546
	4 mm	HP-300-535	HP-300-541	HP-300-547
	5 mm	HP-300-536	HP-300-542	HP-300-548
	6 mm	HP-300-537	HP-300-543	HP-300-549

All sizes are also available in thin footplate and black coating

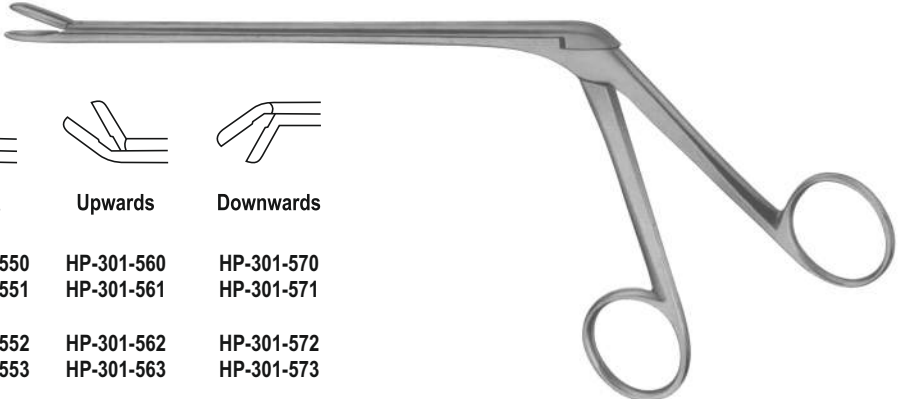
Working Length	Jaw				
		Straight	Upwards	Downwards	
2 mm	16 cm	HP-301-550	HP-301-560	HP-301-570	Caspar HP-301-550 - HP-301-579
	18 cm	HP-301-551	HP-301-561	HP-301-571	
2.5 mm	16 cm	HP-301-552	HP-301-562	HP-301-572	
	18 cm	HP-301-553	HP-301-563	HP-301-573	
3 mm	16 cm	HP-301-554	HP-301-564	HP-301-574	
	18 cm	HP-301-555	HP-301-565	HP-301-575	
4 mm	16 cm	HP-301-556	HP-301-566	HP-301-576	
	18 cm	HP-301-557	HP-301-567	HP-301-577	
5 mm	16 cm	HP-301-558	HP-301-568	HP-301-578	
	18 cm	HP-301-559	HP-301-569	HP-301-579	

Fenestrated jaw, serrated

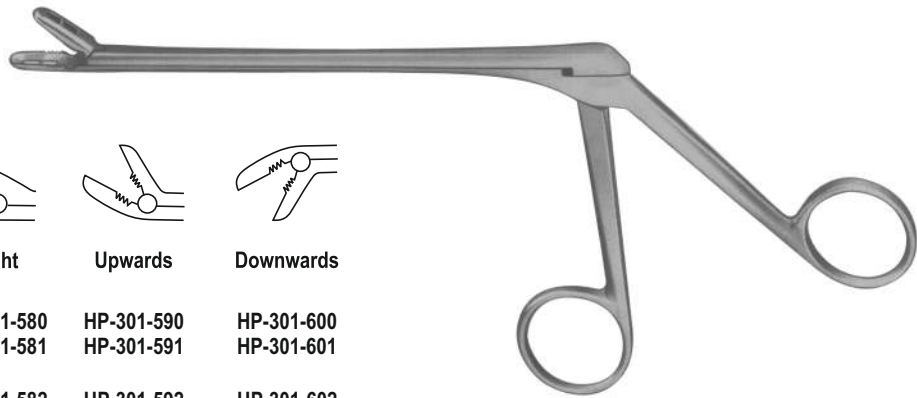
Working Length	Jaw				
		Straight	Upwards	Downwards	
2 mm	16 cm	HP-301-580	HP-301-590	HP-301-600	Caspar HP-301-580 - HP-301-609
	18 cm	HP-301-581	HP-301-591	HP-301-601	
2.5 mm	16 cm	HP-301-582	HP-301-592	HP-301-602	
	18 cm	HP-301-583	HP-301-593	HP-301-603	
3 mm	16 cm	HP-301-584	HP-301-594	HP-301-604	
	18 cm	HP-301-585	HP-301-595	HP-301-605	
4 mm	16 cm	HP-301-586	HP-301-596	HP-301-606	
	18 cm	HP-301-587	HP-301-597	HP-301-607	
5 mm	16 cm	HP-301-588	HP-301-598	HP-301-608	
	18 cm	HP-301-589	HP-301-599	HP-301-609	

Fenestrated jaw, serrated

All sizes are also available in black coating

Rongeurs
Nagetiere
roedores
roedores

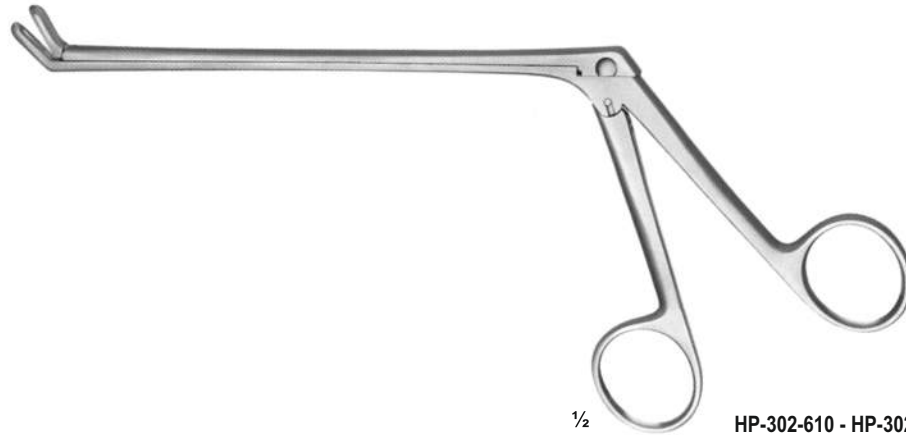

HP-302-610 - HP-302-636

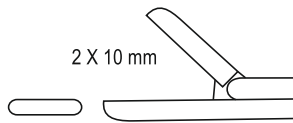

Cushing
HP-302-610 12 cm
HP-302-611 15 cm
HP-302-612 18 cm
Straight

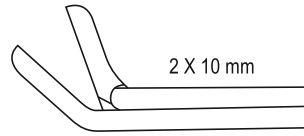

Cushing
HP-302-613 12 cm
HP-302-614 15 cm
HP-302-615 18 cm
Upwards

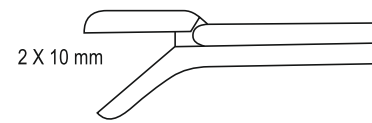

Cushing
HP-302-616 12 cm
HP-302-617 15 cm
HP-302-618 18 cm
Downwards

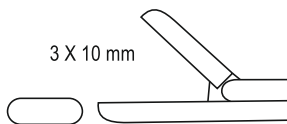

Love-Gruenwald
HP-302-619 12 cm
HP-302-620 15 cm
HP-302-621 18 cm
Straight

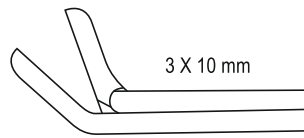

Love-Gruenwald
HP-302-622 12 cm
HP-302-623 15 cm
HP-302-624 18 cm
Upwards

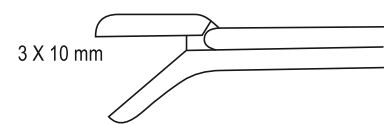

Love-Gruenwald
HP-302-625 12 cm
HP-302-626 15 cm
HP-302-627 18 cm
Downwards

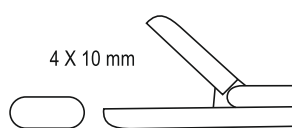

Spurling
HP-302-628 12 cm
HP-302-629 15 cm
HP-302-630 18 cm
Straight

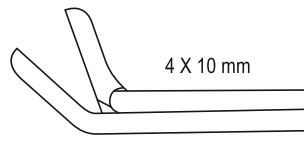

Spurling
HP-302-631 12 cm
HP-302-632 15 cm
HP-302-633 18 cm
Upwards

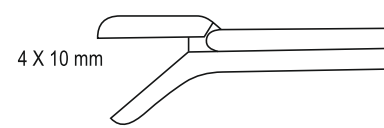

Spurling
HP-302-634 12 cm
HP-302-635 15 cm
HP-302-636 18 cm
Downwards

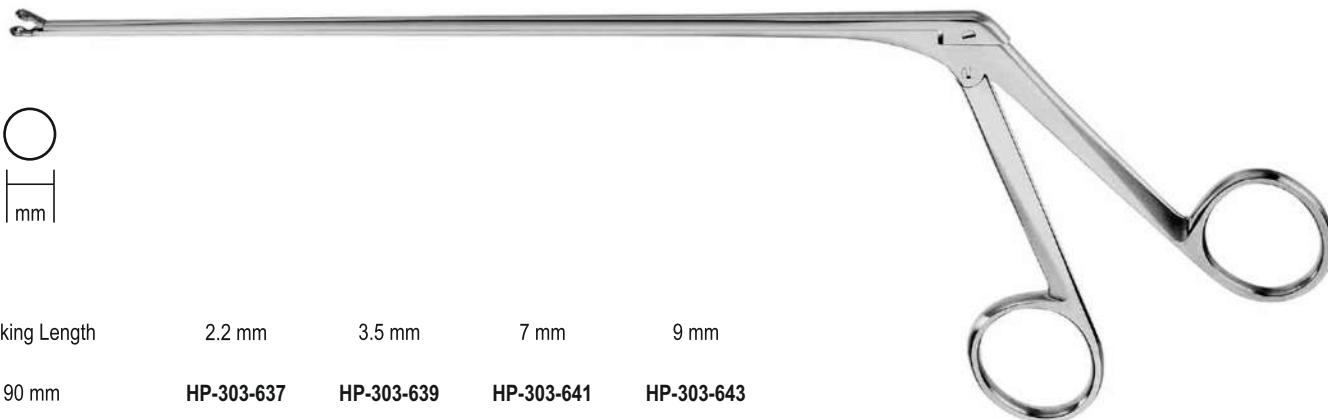

All sizes are also available in black coating

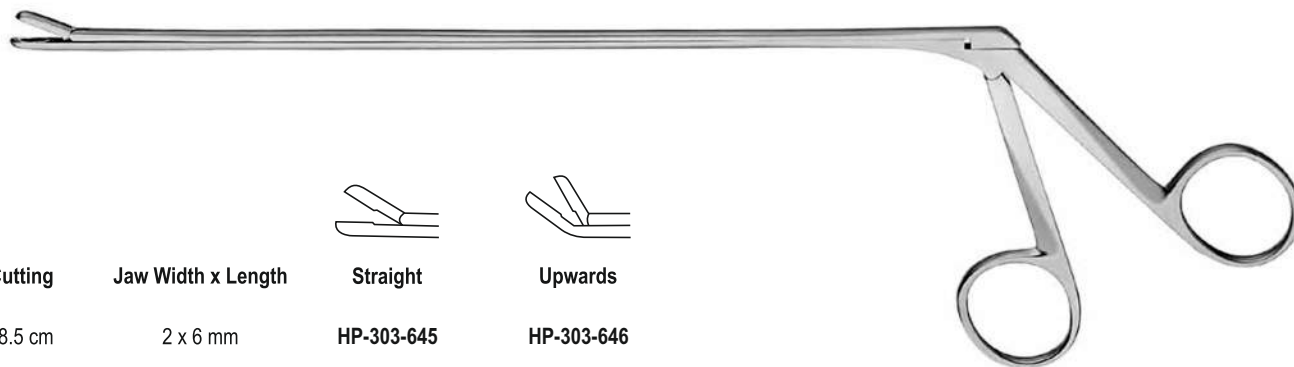

Working Length	2.2 mm	3.5 mm	7 mm	9 mm
190 mm	HP-303-637	HP-303-639	HP-303-641	HP-303-643
140 mm	HP-303-638	HP-303-640	HP-303-642	HP-303-644

Oldberg
HP-303-637 - HP-303-644









Cutting	Jaw Width x Length	 Straight	 Upwards
18.5 cm	2 x 6 mm	HP-303-645	HP-303-646

Decker
HP-303-645 - HP-303-646
Micro disc rongeur

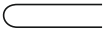

All sizes are also available in black coating

Rongeurs
Nagetiere
roedores
roedores

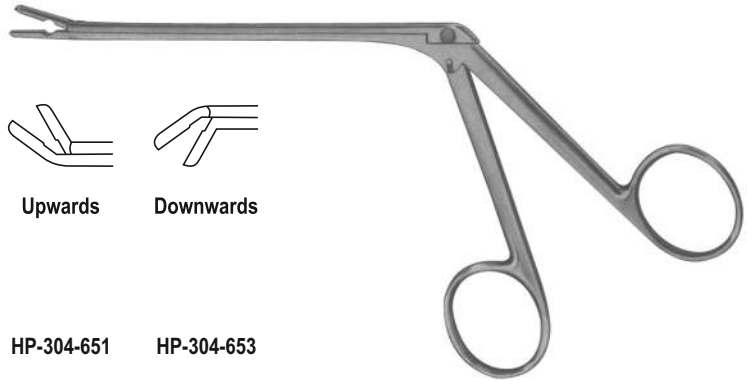
Jaw	Working Length	Straight	Upwards	Downwards
 2 mm Beck	130 mm			
 3 mm St. Barts	114 mm	HP-304-647	HP-304-651	HP-304-653
 3 mm Takahashi	120 mm	HP-304-648	HP-304-652	
 3 mm Penny-Backer	120 mm	HP-304-649		



Takahashi
HP-304-647 - HP-304-653

Jaw	Working Length	Straight	
 2.2 mm	190 mm	HP-304-654	Sharp pituitary rongeur
 9 mm	200 mm	HP-304-655	Tumor grasping forceps, blunt

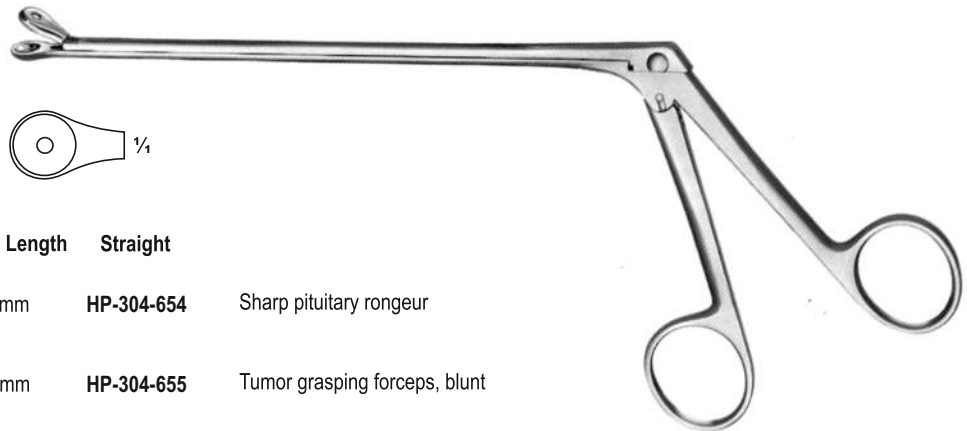







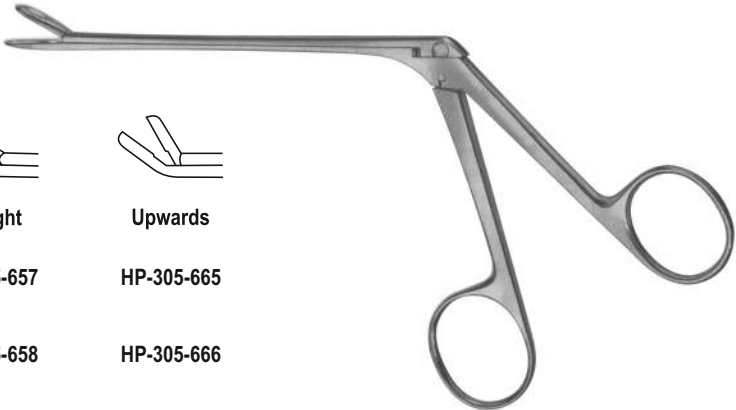

Landolt
HP-304-654 - HP-304-655

Jaw	Working Length	Straight	
 3.5 mm	190 mm	HP-304-656	Sharp pituitary rongeur





Yasargil
HP-304-656

All sizes are also available in black coating

	Jaw	Working Length	Straight	Upwards	
	2 mm	120 mm	HP-305-657	HP-305-665	
	2.5 mm	120 mm	HP-305-658	HP-305-666	
	3 mm	120 mm	HP-305-659	HP-305-667	
	3.5 mm	120 mm	HP-305-660	HP-305-668	
	4 mm	120 mm	HP-305-661	HP-305-669	
	4.5 mm	120 mm	HP-305-662	HP-305-670	
	5 mm	120 mm	HP-305-663	HP-305-671	
	6 mm	120 mm	HP-305-664	HP-305-672	

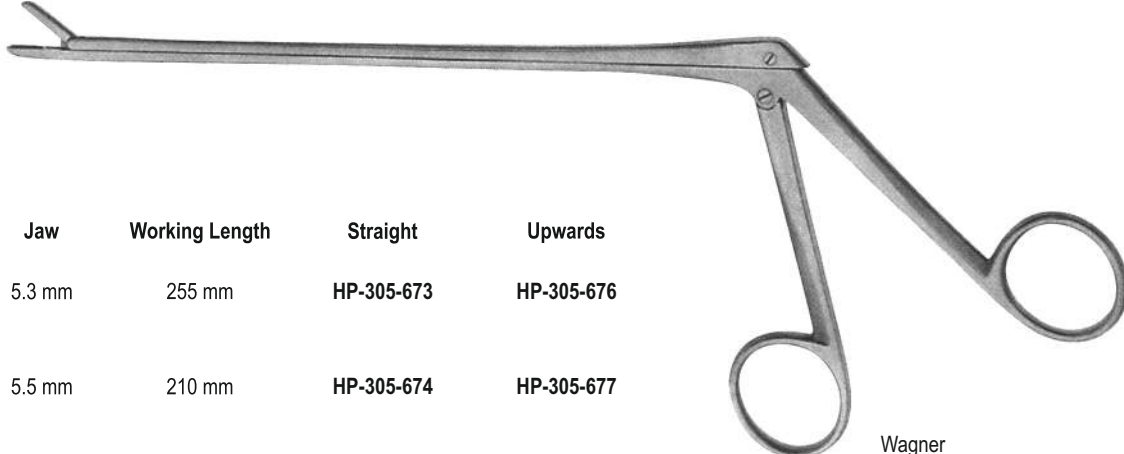
Weil-Blakesley
HP-305-657 - HP-305-672



	Jaw	Working Length	Straight	Upwards	
	5.3 mm	255 mm	HP-305-673	HP-305-676	
	5.5 mm	210 mm	HP-305-674	HP-305-677	
	5.8 mm	255 mm	HP-305-675	HP-305-678	

Wagner
HP-305-673 - HP-305-678

All sizes are also available in black coating

Rongeurs
Nagetiere
roedores
roedores



	Jaw	Working Length	Straight
	2 x 10 mm	130 mm	HP-306-679
	3 x 10 mm	130 mm	HP-306-680
	4 x 10 mm	130 mm	HP-306-681

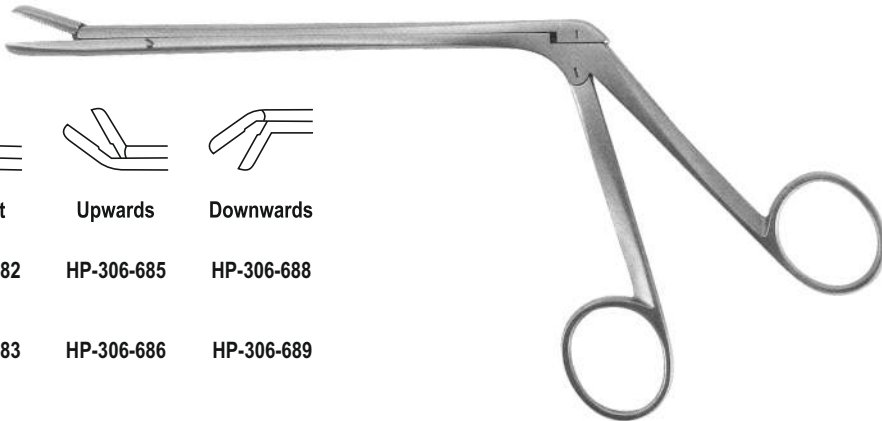

Schlesinger
HP-306-679 - HP-306-681

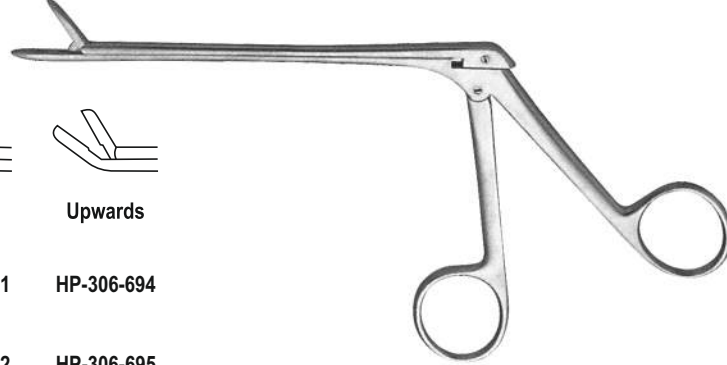

Jaw	Working Length	Straight	Upwards	Downwards	
	6 x 10 mm	120 mm	HP-306-682	HP-306-685	HP-306-688
6 x 10 mm	150 mm	HP-306-683	HP-306-686	HP-306-689	
6 x 10 mm	180 mm	HP-306-684	HP-306-687	HP-306-690	

Cloward
HP-306-682 - HP-306-690









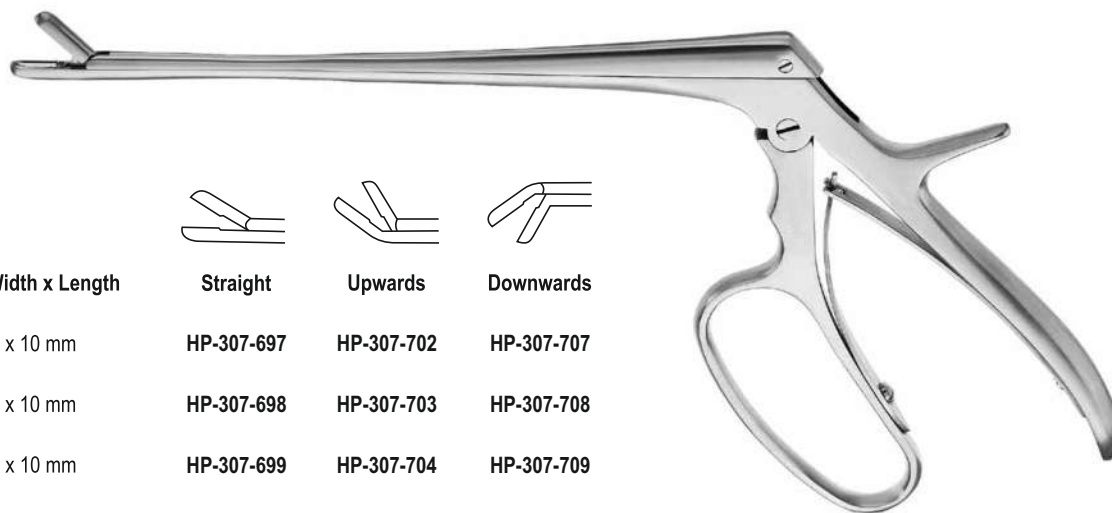

	Jaw	Working Length	Straight	Upwards
	3 x 8 mm	130 mm 170 mm	HP-306-691	HP-306-694
	4 x 10 mm	130 mm 170 mm	HP-306-692	HP-306-695
	5 x 12 mm	130 mm 170 mm	HP-306-693	HP-306-696

Wilde
HP-306-691 - HP-306-696

All sizes are also available in black coating





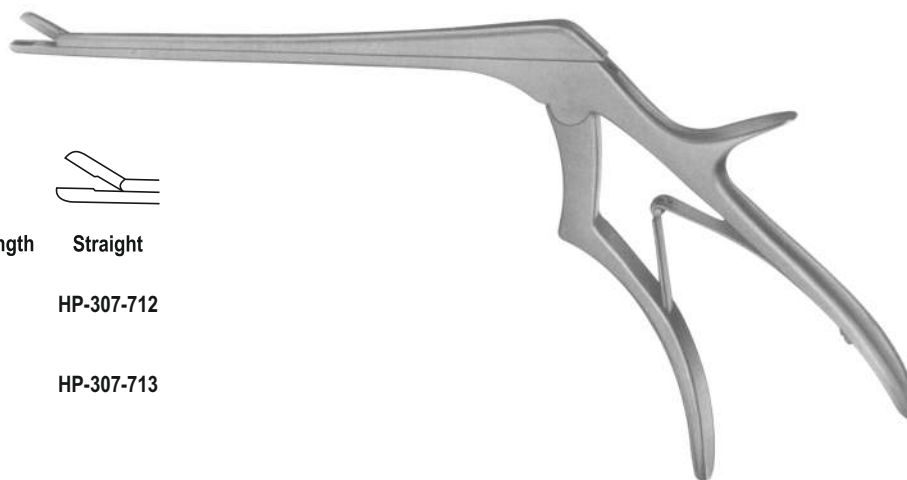

Ferris-Smith
HP-307-697 - HP-307-711

	Working Length	Jaw Width x Length	 Straight	 Upwards	 Downwards
	180 mm	2 x 10 mm	HP-307-697	HP-307-702	HP-307-707
	180 mm	3 x 10 mm	HP-307-698	HP-307-703	HP-307-708
	180 mm	4 x 10 mm	HP-307-699	HP-307-704	HP-307-709
	180 mm	5 x 10 mm	HP-307-700	HP-307-705	HP-307-710
	180 mm	6 x 10 mm	HP-307-701	HP-307-706	HP-307-711

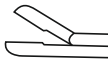

Caspar
HP-307-712 - HP-307-714

	Jaw		Working Length	 Straight
	3 mm	Caspar	130 mm	HP-307-712
	4 mm	Caspar	145 mm 180 mm 220 mm	HP-307-713
	5.5 mm	Wagner	220 mm	HP-307-714

All sizes are also available in black coating

Retractors For Cervical Vertebral Column

Retraktoren für Halswirbelsäule
Retradores Para Coluna Vertebral Cervical
Retradores para Columna Vertebral Cervical



Caspar
HP-308-715
Transverse Retractor hinged
65 mm regular spread
11 cm wide spread



Caspar
HP-308-716
Transverse Retractor double-hinged
65 mm spread



Caspar
HP-308-717
Longitudinal Retractor double-hinged,
ring handle
20.5 cm 85 mm spread



Caspar
HP-308-718
Specula Retractor single-hinged,
11.5 cm
70 mm regular spread



HP-308-719 - HP-308-726
HP-308-719 23 x 35 mm
HP-308-720 23 x 40 mm
HP-308-721 23 x 45 mm
HP-308-722 23 x 50 mm
HP-308-723 23 x 55 mm
HP-308-724 23 x 60 mm
HP-308-725 23 x 65 mm
HP-308-726 23 x 70 mm
Medial Toothed Blades
Stainless Steel



HP-308-727 - HP-308-731
HP-308-727 15 x 40 mm
HP-308-728 15 x 45 mm
HP-308-729 15 x 50 mm
HP-308-730 15 x 55 mm
HP-308-731 15 x 60 mm
Small Lateral Blades
Stainless Steel



HP-308-732 - HP-308-738
HP-308-732 23 x 40 mm
HP-308-733 23 x 45 mm
HP-308-734 23 x 50 mm
HP-308-735 23 x 55 mm
HP-308-736 23 x 60 mm
HP-308-737 23 x 65 mm
HP-308-738 23 x 70 mm
Lateral Serrated Blades
Stainless Steel



Cervical Blades
Stainless Steel – fenestrated
HP-308-739 - HP-308-740
HP-308-739 25 x 50 mm
HP-308-740 25 x 60 mm



HP-308-741 - HP-308-749
HP-308-741 23 x 35 mm
HP-308-742 23 x 40 mm
HP-308-743 23 x 45 mm
HP-308-744 23 x 50 mm
HP-308-745 23 x 55 mm
HP-308-746 23 x 60 mm
HP-308-747 23 x 65 mm
HP-308-748 23 x 70 mm
HP-308-749 23 x 75 mm
Blunt Blades
Stainless Steel



HP-308-750 - HP-308-754
HP-308-750 23 x 40 mm
HP-308-751 23 x 45 mm
HP-308-752 23 x 50 mm
HP-308-753 23 x 55 mm
HP-308-754 23 x 60 mm
Medial Toothed Blades
Aluminium – rotatating



HP-308-755 - HP-308-759
HP-308-755 23 x 40 mm
HP-308-756 23 x 45 mm
HP-308-757 23 x 50 mm
HP-308-758 23 x 55 mm
HP-308-759 23 x 60 mm
Lateral Serrated Blades
Aluminium – rotatating



HP-308-760 - HP-308-764
HP-308-760 23 x 45 mm
HP-308-761 23 x 50 mm
HP-308-762 3 x 55 mm
HP-308-763 23 x 60 mm
HP-308-764 23 x 65 mm
Blunt Blades
Aluminium – rotatating

Retractors For Cervical Vertebral Column

Retraktoren für Halswirbelsäule
Retratores Para Coluna Vertebral Cervical
Retradores para Columna Vertebral Cervical



Transverse Retractor hinged
HP-309-765
65 mm spread



Specula Retractor
HP-309-766
single-hinged
11.5 cm,
70 mm spread



Longitudinal Retractor
HP-309-767
single-hinged ring handle
17.5 cm
70 mm spread



HP-309-768 - HP-309-775
HP-309-768 20 x 40 mm
HP-309-769 20 x 45 mm
HP-309-770 20 x 50 mm
HP-309-771 20 x 55 mm
HP-309-772 20 x 60 mm
HP-309-773 20 x 65 mm
HP-309-774 20 x 70 mm
HP-309-775 20 x 75 mm
Medial Toothed Blades



HP-309-776 - HP-309-786
HP-309-776 20 x 25 mm
HP-309-777 20 x 30 mm
HP-309-778 20 x 35 mm
HP-309-779 20 x 40 mm
HP-309-780 20 x 45 mm
HP-309-781 20 x 50 mm
HP-309-782 20 x 55 mm
HP-309-783 20 x 60 mm
HP-309-784 20 x 65 mm
HP-309-785 20 x 70 mm
HP-309-786 20 x 75 mm
Lateral Serrated Blades



HP-309-787 - HP-309-796
HP-309-787 20 x 30 mm
HP-309-788 20 x 35 mm
HP-309-789 20 x 40 mm
HP-309-790 20 x 45 mm
HP-309-791 20 x 50 mm
HP-309-792 20 x 55 mm
HP-309-793 20 x 60 mm
HP-309-794 20 x 65 mm
HP-309-795 20 x 70 mm
HP-309-796 20 x 75 mm



HP-309-797 - HP-309-804
HP-309-797 20 x 35 mm
HP-309-798 20 x 40 mm
HP-309-799 20 x 45 mm
HP-309-800 20 x 50 mm
HP-309-801 20 x 55 mm
HP-309-802 20 x 60 mm
HP-309-803 20 x 65 mm
HP-309-804 20 x 70 mm
Medial Toothed Blades
fenestrated



HP-309-805 - HP-309-814
HP-309-805 20 x 25 mm
HP-309-806 20 x 30 mm
HP-309-807 20 x 35 mm
HP-309-808 20 x 40 mm
HP-309-809 20 x 45 mm
HP-309-810 20 x 50 mm
HP-309-811 20 x 55 mm
HP-309-812 20 x 60 mm
HP-309-813 20 x 65 mm
HP-309-814 20 x 70 mm
Lateral Serrated Blades
Fenestrated



HP-309-815 - HP-309-823
HP-309-815 20 x 35 mm
HP-309-816 20 x 40 mm
HP-309-817 20 x 45 mm
HP-309-818 20 x 50 mm
HP-309-819 20 x 55 mm
HP-309-820 20 x 60 mm
HP-309-821 20 x 65 mm
HP-309-822 20 x 70 mm
HP-309-823 20 x 75 mm
Blunt Blades Fenestrated

Retractors For Cervical Vertebral Column

Retraktoren für Halswirbelsäule
Retratores Para Coluna Vertebral Cervical
Retradores para Columna Vertebral Cervical



Transverse Retractor
HP-310-824
Hinged spreading
60 mm



Transverse Retractor
HP-310-825
Double-hinged spreading
65 mm



Transverse Retractor
HP-310-826
17.5 cm
single-hinged ring handle
spreading
70 mm



Transverse Retractor
HP-310-827
17.5 cm
Single-hinged ring handle
spreading
70 mm



HP-311-828 - HP-311-834
 HP-311-828 12 x 40 mm
 HP-311-829 12 x 45 mm
 HP-311-830 12 x 50 mm
 HP-311-831 12 x 55 mm
 HP-311-832 12 x 60 mm
 HP-311-833 12 x 65 mm
 HP-311-834 12 x 75 mm
 Small Lateral Serrated
 Blades PEEK



HP-311-835 - HP-311-841
 HP-311-835 23 x 40 mm
 HP-311-836 23 x 45 mm
 HP-311-837 23 x 50 mm
 HP-311-838 23 x 55 mm
 HP-311-839 23 x 60 mm
 HP-311-840 23 x 65 mm
 HP-311-841 23 x 75 mm
 Lateral Serrated Blades
 PEEK



HP-311-842 - HP-311-847
 HP-311-842 23 x 40 mm
 HP-311-843 23 x 45 mm
 HP-311-844 23 x 55 mm
 HP-311-845 23 x 60 mm
 HP-311-846 23 x 65 mm
 HP-311-847 23 x 75 mm
 Blunt Blades PEEK



HP-311-848 - HP-311-854
 HP-311-848 23 x 40 mm
 HP-311-849 23 x 45 mm
 HP-311-850 23 x 50 mm
 HP-311-851 23 x 55 mm
 HP-311-852 23 x 60 mm
 HP-311-853 23 x 65 mm
 HP-311-854 23 x 75 mm
 Medial Toothed Blades
 PEEK



HP-311-855 - HP-311-861
 HP-311-855 23 x 40 mm
 HP-311-856 23 x 45 mm
 HP-311-857 23 x 50 mm
 HP-311-858 23 x 55 mm
 HP-311-859 23 x 60 mm
 HP-311-860 23 x 65 mm
 HP-311-861 23 x 75 mm
 Lateral Serrated Blades
 PEEK – rotating



HP-311-862 - HP-311-868
 HP-311-862 23 x 40 mm
 HP-311-863 23 x 45 mm
 HP-311-864 23 x 50 mm
 HP-311-865 23 x 55 mm
 HP-311-866 23 x 60 mm
 HP-311-867 23 x 65 mm
 HP-311-868 23 x 75 mm
 Blunt Blades
 PEEK – rotating

Retractors For Cervical Vertebral Column

Retraktoren für Halswirbelsäule
Retratores Para Coluna Vertebral Cervical
Retradores para Columna Vertebral Cervical



Transverse Retractor
HP-312-869
Double-hinged
quick connect 72 mm spread, side-loading



1/2
Specula Retractor
HP-312-870
11.5 cm
Single-hinged,
quick connect side-loading
spreading 70 mm



1/2
Longitudinal Retractor
HP-312-871
18.5 cm
Double-hinged,
ring handle, quick connect side-loading
spreading 75 mm



1/2
Quick
HP-312-872
21 cm
Connect blade positioner Handle
for quick connect blades only



HP-313-873 - HP-313-877
HP-313-873 23 x 40 mm
HP-313-874 23 x 45 mm
HP-313-875 23 x 50 mm
HP-313-876 23 x 55 mm
HP-313-877 23 x 60 mm
 Medial Toothed Blades
 Stainless Steel
 quick connect



HP-313-878 - HP-313-882
HP-313-878 23 x 40 mm
HP-313-879 23 x 45 mm
HP-313-880 23 x 50 mm
HP-313-881 23 x 55 mm
HP-313-882 23 x 60 mm
 Lateral Serrated Blades
 Stainless Steel
 quick connect



HP-313-883 - HP-313-887
HP-313-883 23 x 45 mm
HP-313-884 23 x 50 mm
HP-313-885 23 x 55 mm
HP-313-886 23 x 60 mm
HP-313-887 23 x 65 mm
 Blunt Blades
 Stainless Steel
 quick connect



HP-313-888 - HP-313-892
HP-313-888 23 x 40 mm
HP-313-889 23 x 45 mm
HP-313-890 23 x 50 mm
HP-313-891 23 x 55 mm
HP-313-892 23 x 60 mm
 Medial Toothed Blades
 Titanium
 quick connect



HP-313-893 - HP-313-897
HP-313-893 23 x 40 mm
HP-313-894 23 x 45 mm
HP-313-895 23 x 50 mm
HP-313-896 23 x 55 mm
HP-313-897 23 x 60 mm
 Lateral Serrated Blades
 Titanium
 quick connect



HP-313-898 - HP-313-902
HP-313-898 23 x 45 mm
HP-313-899 23 x 50 mm
HP-313-900 23 x 55 mm
HP-313-901 23 x 60 mm
HP-313-902 23 x 65 mm
 Blunt Blades
 Titanium
 quick connect

Retractors For Cervical Vertebral Column

Retraktoren für Halswirbelsäule
Retratores Para Coluna Vertebral Cervical
Retradores para Columna Vertebral Cervical

14



HP-314-903



HP-314-904



HP-314-905



HP-314-906



HP-314-907



HP-314-908



HP-314-909



HP-314-910



HP-314-911



HP-314-912

Caspar Cervical Spine Retractor

HP-314-903 - HP-314-912

Stainless steel, complete set for transverse retraction, spreading 65 mm, adjustable, with 5 medial and 5 lateral stainless steel blades 40, 45, 50, 55, 60 mm

TI Caspar Cervical Spine Retractor

HP-314-913

Titanium, complete set for transverse retraction, spreading 65 mm, adjustable, with 5 medial and 5 lateral titanium blades 40, 45, 50, 55, 60 mm



Caspur Microdiscectomy Retractor
 HP-315-914 - HP-315-929

For micro surgical treatment of
 herniated lumbar discs
 spreading
 45 mm

Frame only, hinged



- HP-315-914 - HP-315-922
 HP-315-914 35 mm
 HP-315-915 40 mm
 HP-315-916 45 mm
 HP-315-917 50 mm
 HP-315-918 55 mm
 HP-315-919 60 mm
 HP-315-920 65 mm
 HP-315-921 75 mm
 HP-315-922 85 mm
 Lateral Blades



- HP-315-923 - HP-315-929
 HP-315-923 40 mm
 HP-315-924 45 mm
 HP-315-925 50 mm
 HP-315-926 55 mm
 HP-315-927 60 mm
 HP-315-928 65 mm
 HP-315-929 70 mm
 Paraspinal blade



- Lumbar Speculum
 HP-315-930 - HP-315-939
 HP-315-930 40 mm
 HP-315-931 45 mm
 HP-315-932 50 mm
 HP-315-933 55 mm
 HP-315-934 60 mm
 HP-315-935 65 mm
 HP-315-936 70 mm
 HP-315-937 75 mm
 HP-315-938 80 mm
 HP-315-939 85 mm
 Fenestrated

Retractors For Cervical Vertebral Column

Retraktoren für Halswirbelsäule
Retratores Para Coluna Vertebral Cervical
Retradores para Columna Vertebral Cervical



HP-316-944 - HP-316-949
HP-316-944 20 x 30 mm
HP-316-945 20 x 40 mm
HP-316-946 20 x 50 mm
HP-316-947 20 x 60 mm
HP-316-948 20 x 70 mm
HP-316-949 20 x 80 mm
 McCulloch 4-teeth
 Narrow Muscle Blades



HP-316-950 - HP-316-955
HP-316-950 20 x 30 mm
HP-316-951 20 x 40 mm
HP-316-952 20 x 50 mm
HP-316-953 20 x 60 mm
HP-316-954 20 x 70 mm
HP-316-955 20 x 80 mm
 McCulloch 6-teeth
 Wide Muscle Blades

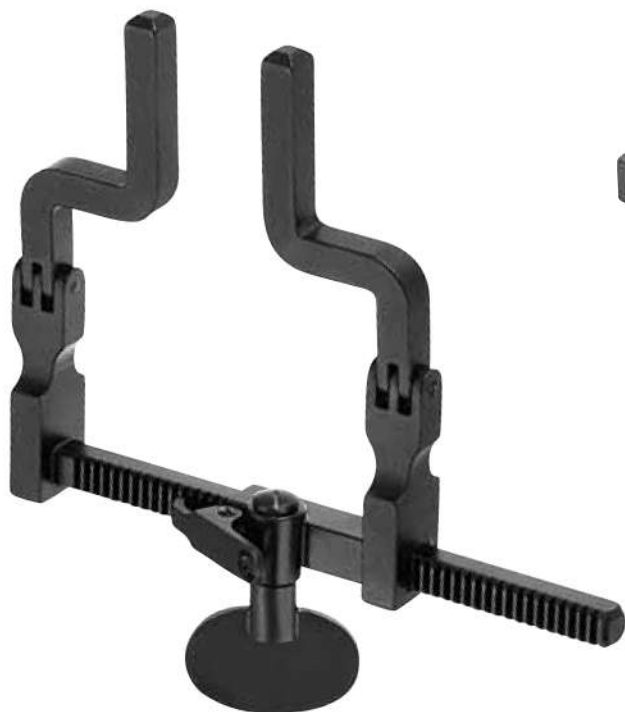

HP-316-956 - HP-316-961
HP-316-956 20 x 30 mm
HP-316-957 20 x 40 mm
HP-316-958 20 x 50 mm
HP-316-959 20 x 60 mm
HP-316-960 20 x 70 mm
HP-316-961 20 x 80 mm
 McCulloch 2-teeth
 Thin Muscle Blades



HP-316-962 - HP-316-969
HP-316-962 20 mm
HP-316-963 30 mm
HP-316-964 40 mm
HP-316-965 50 mm
HP-316-966 60 mm
HP-316-967 70 mm
HP-316-968 80 mm
HP-316-969 90 mm
 McCulloch Hook Blades



HP-316-970 - HP-316-977
HP-316-970 20 mm
HP-316-971 30 mm
HP-316-972 40 mm
HP-316-973 50 mm
HP-316-974 60 mm
HP-316-975 70 mm
HP-316-976 80 mm
HP-316-977 90 mm
 McCulloch toothed
 Hook Blades



HP-316-978 - HP-316-980
HP-316-978 20 x 50 mm
HP-316-979 20 x 60 mm
HP-316-980 20 x 70 mm
 McCulloch 2-teeth
 Cervical Blades

McCulloch Lumbar Spine Retractor for Microdiscectomy,
black silicone bead

HP-316-940 68 mm spread, hinged
HP-316-941 68 mm spread, rigid
HP-316-942 90 mm spread, rigid

McCulloch Lumbar Spine Retractor Tray
HP-316-943 Tray 265 x 265 mm for Container (not illustrated)

HP-316-940 - HP-316-980



Caspar Vertebral Column Retractor
HP-317-981
 for Laminectomy and Hemilaminectomy (Lumbar, Thoracic, Cervical), stainless steel, complete set, 145 mm spreading, 12.5 cm arms, 14.5 cm spread,



Caspar
HP-317-983
 Srew driver for spreading bar



Caspar
HP-317-984
 Blade Changing Forceps
 11.5 cm

HP-317-982 Frame only, 145 mm spread, hinged



HP-317-985 - HP-317-986
HP-317-985 38 mm
HP-317-986 58 mm



HP-317-987 - HP-317-994
HP-317-987 22 x 32 mm
HP-317-988 22 x 37 mm
HP-317-989 22 x 43 mm
HP-317-990 22 x 47 mm
HP-317-991 22 x 52 mm
HP-317-992 22 x 57 mm
HP-317-993 22 x 62 mm
HP-317-994 22 x 67 mm



HP-317-995 - HP-317-1002
HP-317-995 37 x 32 mm
HP-317-996 37 x 37 mm
HP-317-997 37 x 43 mm
HP-317-998 37 x 47 mm
HP-317-999 37 x 52 mm
HP-317-1000 37 x 57 mm
HP-317-1001 37 x 62 mm
HP-317-1002 37 x 67 mm



HP-317-1003 - HP-317-1010
HP-317-1003 57 x 32 mm
HP-317-1004 57 x 37 mm
HP-317-1005 57 x 43 mm
HP-317-1006 57 x 47 mm
HP-317-1007 57 x 52 mm
HP-317-1008 57 x 57 mm
HP-317-1009 57 x 62 mm
HP-317-1010 57 x 67 mm



Caspar
HP-318-1011
Distractor only for use in surgical procedures from the left approach the right approach for the upper cervical spine

HP-318-1012
Distractor as above but with elongated toothed bar for multilevel (more than 2) distraction



Drill guide
HP-318-1018

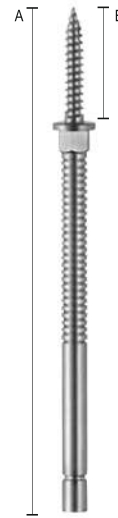

Distraction Pin A/B
HP-318-1013 - HP-318-1016
HP-318-1013 66/12 mm
HP-318-1014 68/14 mm
HP-318-1015 70/16 mm
HP-318-1016 72/18 mm



Twist Drill
HP-318-1017



Screw Driver
HP-318-1019



Caspar
HP-319-1020
Distractor only for use in surgical procedures from the left approach the right approach for the upper cervical spine

HP-319-1021
Distractor as above but with elongated toothed bar for multilevel (more than 2) distraction



Drill Guide
HP-319-1027

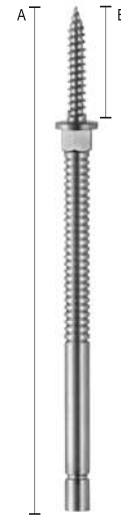

Distraction Pin A/B
HP-319-1022 - HP-319-1025
HP-319-1022 66/12 mm
HP-319-1023 68/14 mm
HP-319-1024 70/16 mm
HP-319-1025 72/18 mm



Twist Drill
HP-319-1026



Screw Driver
HP-319-1028

Vertebral and Lamina Spreaders

Vertebral- und Lamina-Spreizer
Espalhadores vertebrais e laminados
Esparcidores vertebrales y laminares

14



Cloward-Type
HP-320-1029
Vertebra Spreaders
13 cm
18 mm spread



HP-320-1030
One pointed tip
7 cm arm
80 mm spread



Three pointed tips
HP-320-1031 - HP-320-1032
HP-320-1031
8.5 cm arm,
70 mm spread
HP-320-1032
10 cm arm
70 mm spread

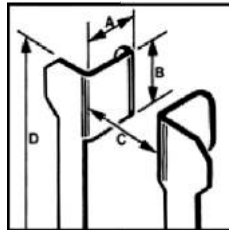
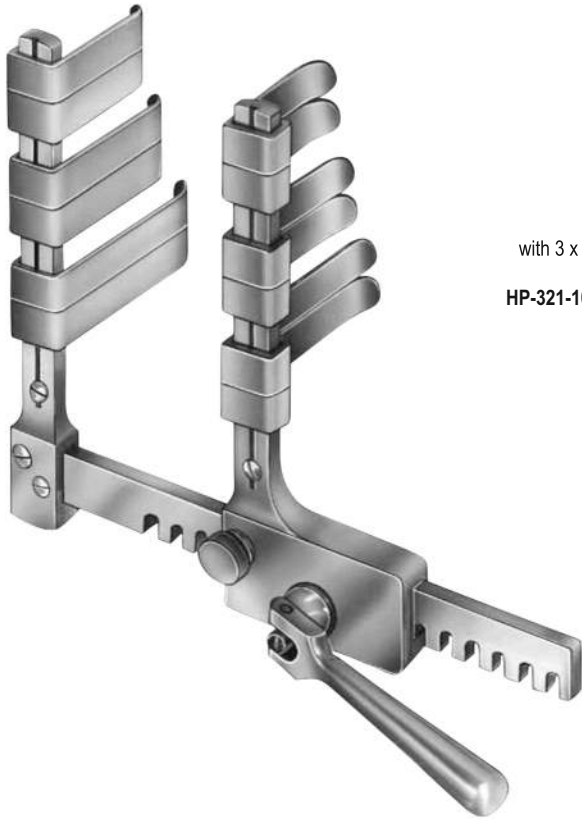

with 3 x 2 pairs of movable blunt blades

	A	B	C	D
HP-321-1033	40 mm	12 mm	110 mm	132 mm
	50 mm	12 mm		
	65 mm	12 mm		

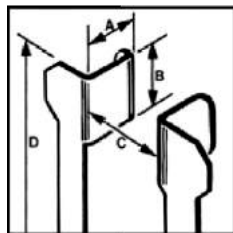

Badgley

	A	B	C	D
HP-321-1034	48 mm	45 mm	170 mm	110 mm

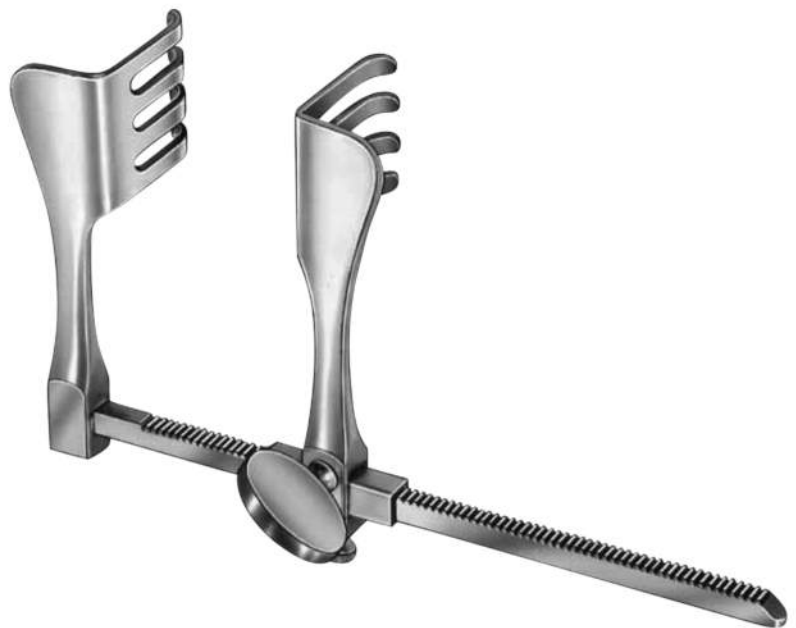

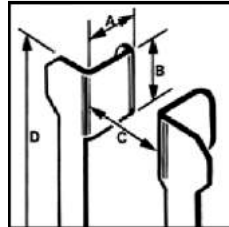

Toothed:

- HP-322-1043 - HP-322-048
- HP-322-1043 63 mm x 26 mm
- HP-322-1044 66 mm x 30 mm
- HP-322-1045 89 mm x 26 mm
- HP-322-1046 51 mm x 51 mm
- HP-322-1047 63 mm x 51 mm
- HP-322-1048 76 mm x 51 mm



3-prongs:

- HP-322-1037 44 mm x 38 mm

4-prongs:

- HP-322-1038 - HP-322-1042
- HP-322-1038 41 mm x 38 mm
- HP-322-1039 66 mm x 48 mm
- HP-322-1040 48 mm x 51 mm
- HP-322-1041 63 mm x 63 mm
- HP-322-1042 82 mm x 58 mm



Hook-shaped, blunt:

- HP-322-1049 - HP-322-1050
- HP-322-1049 50 mm
- HP-322-1050 75 mm

Scoville-Haverfield

	A	B	C	D
HP-322-1035	50 mm	35 mm	140 mm	140 mm
	50 mm	D = 5 mm		
with 1 each blade				
Frame only, hinged:				
HP-322-1036	--	--	140 mm	140 mm



Williams

HP-322-1051 - HP-322-1056
for microsurgical treatment
of herniated discs left

- 17 cm
- w = 10 mm
- HP-322-1051 10 x 50 mm
- HP-322-1052 10 x 60 mm
- HP-322-1053 10 x 70 mm

- w = 20 mm
- HP-322-1054 20 x 50 mm
- HP-322-1055 20 x 60 mm
- HP-322-1056 20 x 70 mm



Williams

HP-322-1057 - HP-322-1062
for microsurgical treatment
of herniated discs right

- 17 cm
- w = 10 mm
- HP-322-1057 10 x 50 mm
- HP-322-1058 10 x 60 mm
- HP-322-1059 10 x 70 mm

- w = 20 mm
- HP-322-1060 20 x 50 mm
- HP-322-1061 20 x 60 mm
- HP-322-1062 20 x 70 mm



Cloward-Type
HP-323-1063
 25 cm
 Cervical Retractor Set with
 slide-lock complete with 14 blades

HP-323-1064 Retractor body only (without blades)

HP-323-1063 - HP-323-1064



Cloward-Type
HP-323-1065
 16 cm
 Cervical Retractor Set with
 slide-lock complete with 14 blades,

HP-323-1066 Retractor Body only (without blades)

HP-323-1065 - HP-323-1066



HP-323-1067 - HP-323-1073

- HP-323-1067** 25 mm
- HP-323-1068** 30 mm
- HP-323-1069** 35 mm
- HP-323-1070** 40 mm
- HP-323-1071** 45 mm
- HP-323-1072** 50 mm
- HP-323-1073** 55 mm
- Blunt



HP-323-1074 - HP-323-1080

- HP-323-1074** 25 mm
- HP-323-1075** 30 mm
- HP-323-1076** 35 mm
- HP-323-1077** 40 mm
- HP-323-1078** 45 mm
- HP-323-1079** 50 mm
- HP-323-1080** 55 mm
- Blunt



Cloward-Type
HP-324-1081
HP-324-1081 - - HP-324-1092
25.5 cm
Cervical retractor
with ball closure, complete blades
110 mm spreading

HP-324-1082 Retractor body (without blades)

Exchangeable blades



HP-324-1083 - HP-324-1087
HP-324-1083 15 x 40 mm
HP-324-1084 15 x 45 mm
HP-324-1085 15 x 50 mm
HP-324-1086 15 x 55 mm
HP-324-1087 15 x 6 mm
Serrated



HP-324-1088 - HP-324-1092
HP-324-1088 15 x 40 mm
HP-324-1089 15 x 45 mm
HP-324-1090 15 x 50 mm
HP-324-1091 15 x 55 mm
HP-324-1092 15 x 60 mm
Blunt



1/2

Cone
HP-325-1093 - HP-325-1100
HP-325-1093 14 cm, 18 mm 3 x 4
HP-325-1094 6 cm, 18 mm 3 x 4
HP-325-1095 20 cm, 20 mm 3 x 4
HP-325-1096 24 cm, 27 mm 3 x 4
HP-325-1097 14 cm, 18 mm 3 x 4
HP-325-1098 16 cm, 18 mm 3 x 4
HP-325-1099 20 cm, 20 mm 3 x 4
HP-325-1100 24 cm, 27 mm 3 x 4
 Prongs blunt



1/2

Markham-Meyerdig
HP-325-1101
 18 cm
 50 x 25 mm left
 Hemilaminectomy Retractor



1/2

Markham-Meyerdig
HP-325-1102
 18 cm
 50 x 25 mm right
 Hemilaminectomy Retractor

Self-Retaining Retractors

Sich selbst haltende Retraktoren

Retraçadores de Auto-Retenção

Retradores autoretenibles



Mini-Weitlaner

HP-326-1103 - HP-326-1104

11 cm

HP-326-1103 16 mm 2 x 3 prongs sharp

HP-326-1104 16 mm 2 x 3 prongs blunt



Weitlaner

HP-326-1105 - HP-326-1112

HP-326-1105 13 cm, 18 mm 3 x 4 prongs sharp

HP-326-1106 16 cm, 18 mm 3 x 4 prongs sharp

HP-326-1107 20 cm, 21 mm 3 x 4 prongs sharp

HP-326-1108 25 cm, 27 mm 3 x 4 prongs sharp

HP-326-1109 13 cm, 18 mm 3 x 4 prongs blunt

HP-326-1110 16 cm, 18 mm 3 x 4 prongs blunt

HP-326-1111 20 cm, 21 mm 3 x 4 prongs blunt

HP-326-1112 25 cm, 27 mm 3 x 4 prongs blunt



Anderson-Adson

HP-326-1113

20 cm

4 x 4 prongs sharp

Cerebellar Retractor



Weitlaner

HP-327-1114 - HP-327-1115

HP-327-1114 26 cm, 27 mm 5 x 6 prongs sharp

HP-327-1115 26 cm, 27 mm 5 x 6 prongs blunt

Hemilaminectomy

HP-327-1116 - HP-327-1117

HP-327-1116 29 cm, 42 mm 6 x 6 prongs sharp

HP-327-1117 29 cm, 42 mm 6 x 6 prongs blunt

HP-327-1118 - HP-327-1121

Right blade 42 mm, left blade 22 mm deep

HP-327-1118 29 cm, 22/42 mm 6 x 6 prongs sharp

HP-327-1119 29 cm, 22/42 mm 6 x 6 prongs blunt

Right blade 22 mm, left blade 42 mm deep

HP-327-1120 29 cm, 22/42 mm 6 x 6 prongs sharp

HP-327-1121 29 cm, 22/42 mm 6 x 6 prongs blunt

Self-Retaining Retractors

Sich selbst haltende Retraktoren
Retraçadores de Auto-Retenção
Retradores autoretenibles



Scalp Contour

HP-328-1122 - HP-328-1125

- HP-328-1122 14 cm, 18 mm 1 x 1 prongs blunt
- HP-328-1123 14 cm, 18 mm 3 x 3 prongs blunt
- HP-328-1124 14 cm, 18 mm 3 x 4 prongs sharp
- HP-328-1125 14 cm, 18 mm 3 x 4 prongs blunt



Beckmann-Adson

HP-328-1126 - HP-328-1131

- HP-328-1126 31 cm, 25 mm 4 x 4 prongs sharp
- HP-328-1127 31 cm, 37 mm 4 x 4 prongs sharp
- HP-328-1128 31 cm, 48 mm 4 x 4 prongs sharp
- HP-328-1129 31 cm, 25 mm 4 x 4 prongs blunt
- HP-328-1130 31 cm, 37 mm 4 x 4 prongs blunt
- HP-328-1131 31 cm, 48 mm 4 x 4 prongs blunt



Beckmann-Eaton

HP-328-1132

- 32 cm
- 50 mm 7 x 7 prongs sharp



Miskimon
 HP-329-1133 - HP-329-1134
 HP-329-1133 22 cm, 35 mm 7 x 7 prongs sharp
 HP-329-1134 22 cm, 35 mm 7 x 7 prongs blunt



Adson
 HP-329-1135 - HP-329-1136
 HP-329-1135 19 cm, 23 mm 4 x 4 prongs sharp
 HP-329-1136 19 cm, 23 mm 4 x 4 prongs blunt



Adson
 HP-329-1137
 19 cm, 23 mm 4 x 4 prongs sharp



Norfolk & Norwich
HP-330-1138
22 cm
50 mm 4 x 5 prongs blunt
Hemilaminectomy Retractor



Gelpi
HP-330-1139
17.5 cm
Skin retractor



Tracheotomy

Tracheotomie

Traqueotomia

Traqueotomía

Page 331-335

Tracheal Dilators
Trachealdilatatoren
Dilatadores traqueais
Dilatadores traqueales

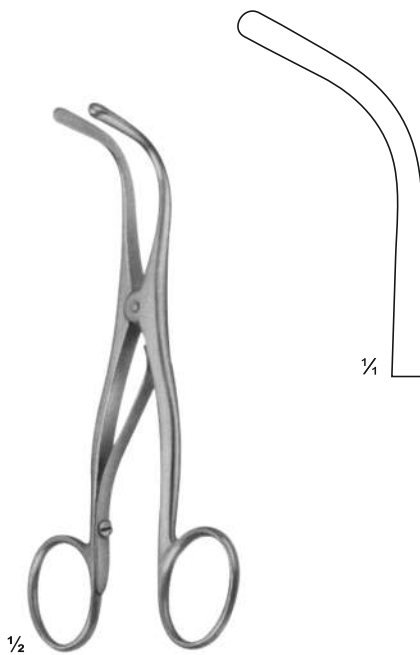

Trousseau
HP-331-001
14.5 cm



Laborde
HP-331-002
strong pattern
13.5 cm



Laborde
HP-331-003
14 cm



Iterson
HP-332-004 - TR-586-005
17 cm



HP-332-004
17 cm
Scharp

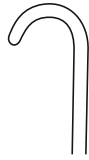

HP-332-005
17 cm
Blunt



Rose
HP-332-006
15.5 cm

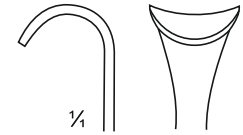

1/4



1/2



Luer
HP-332-007
11 cm

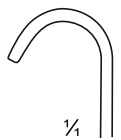

1/4

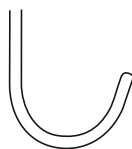

1/2



Lukens
HP-332-008
17.5 cm

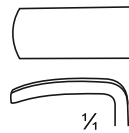

1/4

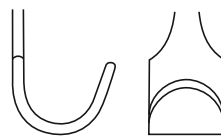

1/2



Jackson
HP-332-009
18 cm

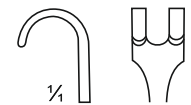

1/4

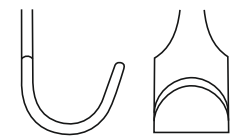

1/2

Cleaning Brush, Goitre Enucleator, Goitre Grasping Forceps
Reinigungsbürste, Kropf Enukleator, Kropfgreifer
Escova de Limpeza, Goitre Enucleator, Goitre Clearing Forceps
Cepillo de limpieza, Enucleador de Goitre, Pinzas de agarre de Goitre



1/2

HP-333-010
26 cm
Cleaning Brush
for tracheal tubes, head of bursh Ø 12 mm

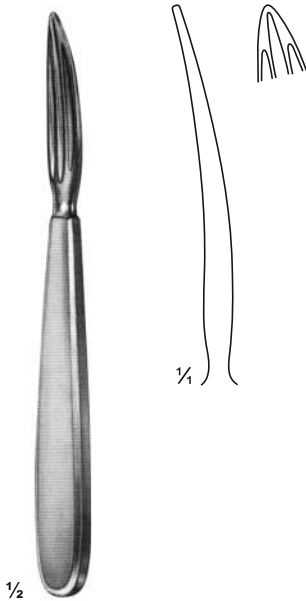

1/4

1/2
Kocher
HP-333-011
15.5 cm

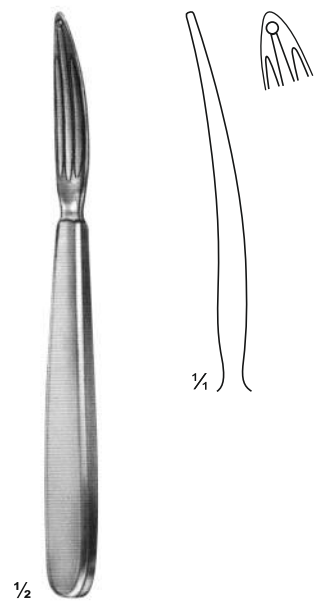

1/4

1/2
Kocher
HP-333-012
15.5 cm
with eye



1/2

Lahey
HP-333-013 - HP-333-014
15.5 cm

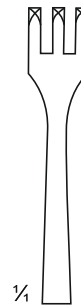

1/4

HP-333-013
15.5 cm



3:3

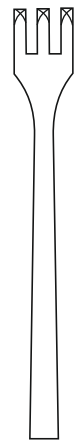

HP-333-014
20 cm



3:3



1/2

Ueckermann-Denker
HP-334-015 - HP-334-054
 13 cm
 Crycothyreotomy trocar
 with silver cannula

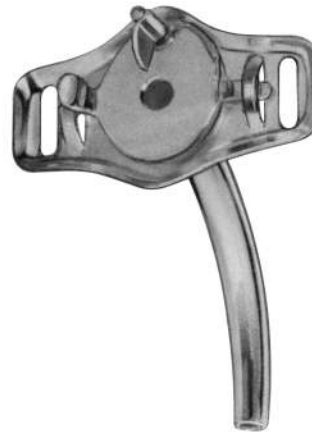

Luer

Radius	Fig.	Dia. x Length	Brass	Magnet S.S.	Non-Magnet S.S.	German Silver S.S.
30 mm	0	4 x 50 mm	HP-334-015	HP-334-025	HP-334-035	HP-334-045
30 mm	1	5 x 50 mm	HP-334-016	HP-334-026	HP-334-036	HP-334-046
30 mm	2	6 x 50 mm	HP-334-017	HP-334-027	HP-334-037	HP-334-047
39 mm	3	7 x 55 mm	HP-334-018	HP-334-028	HP-334-038	HP-334-048
39 mm	4	8 x 60 mm	HP-334-019	HP-334-029	HP-334-039	HP-334-049
39 mm	5	9 x 65 mm	HP-334-020	HP-334-030	HP-334-040	HP-334-050
39 mm	6	10 x 70 mm	HP-334-021	HP-334-031	HP-334-041	HP-334-051
43.5 mm	7	11 x 80 mm	HP-334-022	HP-334-032	HP-334-042	HP-334-052
43.5 mm	8	12 x 85 mm	HP-334-023	HP-334-033	HP-334-043	HP-334-053
43.5 mm	9	13 x 90 mm	HP-334-024	HP-334-034	HP-334-044	HP-334-054

Tracheal Tubes

Trachealtuben
Tubos traqueais
Tubos traqueales



HP-335-055 - HP-335-094
Jackson

Fig.	Dia. x Length	Brass	Magnet S.S.	Non-Magnet S.S.	German Silver S.S.
0	4 x 50 mm	HP-335-055	HP-335-065	HP-335-076	HP-335-085
1	5 x 58 mm	HP-335-056	HP-335-066	HP-335-076	HP-335-086
2	6 x 58 mm	HP-335-057	HP-335-067	HP-335-077	HP-335-087
3	7 x 70 mm	HP-335-058	HP-335-068	HP-335-078	HP-335-088
4	8 x 78 mm	HP-335-059	HP-335-069	HP-335-079	HP-335-089
5	9 x 84 mm	HP-335-060	HP-335-070	HP-335-080	HP-335-090
6	10 x 84 mm	HP-335-061	HP-335-071	HP-335-081	HP-335-091
7	11 x 86 mm	HP-335-062	HP-335-072	HP-335-082	HP-335-092
8	12 x 88 mm	HP-335-063	HP-335-073	HP-335-083	HP-335-093
9	13 x 90 mm	HP-335-064	HP-335-074	HP-335-084	HP-335-094



HP-335-095 - HP-335-137
Chevalier-Jackson

Fig.	Dia. x Length	Brass	Magnet S.S.	Non-Magnet S.S.	German Silver S.S.
0	4 x 50 mm	HP-335-095	HP-335-106	HP-335-117	HP-335-128
1	5 x 58 mm	HP-335-096	HP-335-107	HP-335-118	HP-335-129
2	6 x 58 mm	HP-335-097	HP-335-108	HP-335-119	HP-335-130
3	7 x 70 mm	HP-335-098	HP-335-109	HP-335-120	HP-335-130
4	8 x 78 mm	HP-335-099	HP-335-110	HP-335-121	HP-335-131
5	9 x 84 mm	HP-335-100	HP-335-111	HP-335-122	HP-335-132
6	10 x 84 mm	HP-335-101	HP-335-112	HP-335-123	HP-335-133
7	11 x 86 mm	HP-335-102	HP-335-113	HP-335-124	HP-335-134
8	12 x 88 mm	HP-335-103	HP-335-114	HP-335-125	HP-335-135
9	13 x 90 mm	HP-335-104	HP-335-115	HP-335-126	HP-335-136
10	14 x 90 mm	HP-335-105	HP-335-116	HP-335-127	HP-335-137



Dermatology

Dermatologie

Dermatologia

Dermatología

Page 336-340

Milium Knife, Lupus Instruments

Milium Messer, Lupus Instrumente
Faca Milium, Instrumentos Lupus
Milium Knife, Lupus Instruments



HP-336-001
13 cm
milium knife



HP-336-002
13 cm
Spare Blade

17-100-13

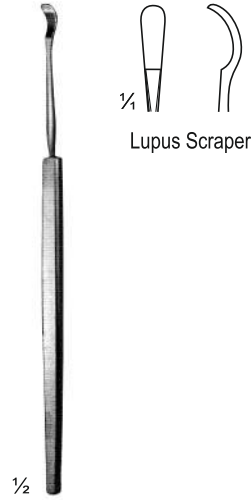

HP-336-003
1/4
Lupus Scraper

Vidal
HP-336-003
13 cm
Lupus scraper

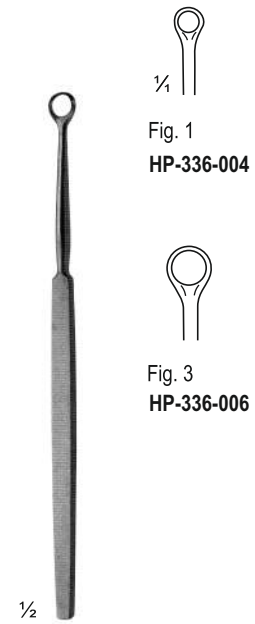

Fig. 1
HP-336-004

Fig. 2
HP-336-005

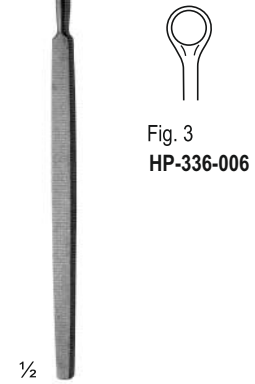

Fig. 3
HP-336-006

Fig. 4
HP-336-007

Fox
HP-336-004 - HP-336-007
14 cm
Lupus curette



Wolff
HP-336-008 - HP-336-013
14 cm
Lupus curette



Fig. 1
HP-336-008



Fig. 2
HP-336-009



Fig. 3
HP-336-010



Fig. 4
HP-336-011



Fig. 5
HP-336-012



Fig. 6
HP-336-013



Kilner
HP-337-014
 14.5 cm
 Skin hooklet
 sharp



Gillies
HP-337-015 - HP-337-016
 18 cm
 Skin hooklet



Fig. 1
HP-337-015
 Small curvature, sharp



Fig. 2
HP-337-016
 Large curvature, sharp

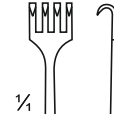

HP-337-017



HP-337-018



Kaye
HP-337-017 - HP-337-018
 13 cm
 Face-lift hook



HP-337-019
 Ø 2 mm



HP-337-020
 Ø 4 mm



HP-337-021
 Ø 6 mm



HP-337-026
 Ø 2 mm



HP-337-027
 Ø 3 mm



HP-337-028
 Ø 4 mm



HP-337-019 - HP-337-024
 5.5 cm
 Dermal punch



HP-337-022
 Ø 8 mm



HP-337-023
 Ø 10 mm



HP-337-024
 Ø 12 mm



Keyes
HP-337-025 - HP-337-032
 11 cm
 Dermal punch



HP-337-029
 Ø 5 mm



HP-337-030
 Ø 6 mm



HP-337-031
 Ø 7 mm



HP-337-032
 Ø 8 mm

Milium Knife, Lupus Instruments

Milium Messer, Lupus Instrumente
Faca Milium, Instrumentos Lupus
Milium Knife, Lupus Instruments

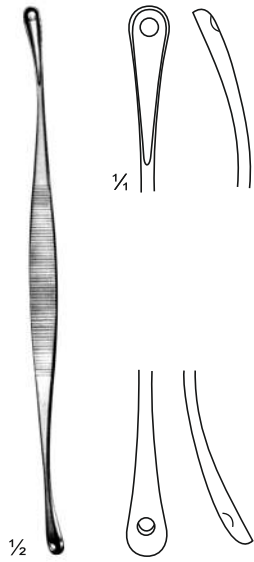

Unna
HP-338-033
14.5 cm



Unna
HP-338-034
14 cm



Saalfeld
HP-338-035
11 cm

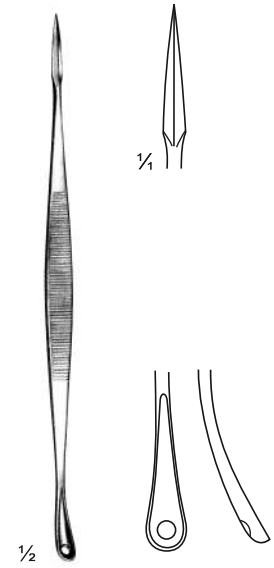

Saalfeld
HP-338-036
14.5 cm

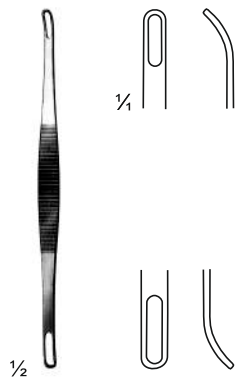

Schamberg
HP-338-037
9.5 cm

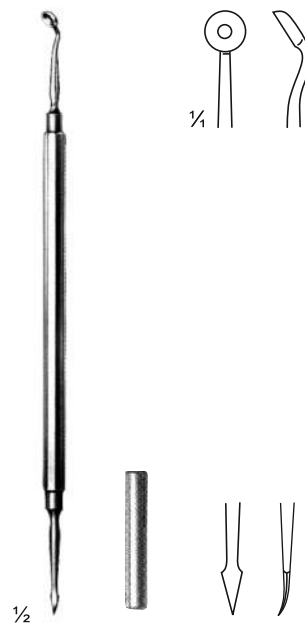

Katsch
HP-338-038
16 cm

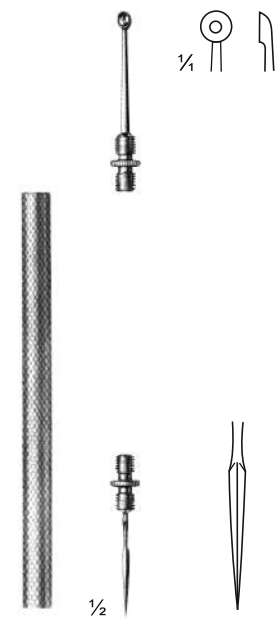

Unna-Vidal
HP-338-039
11 cm

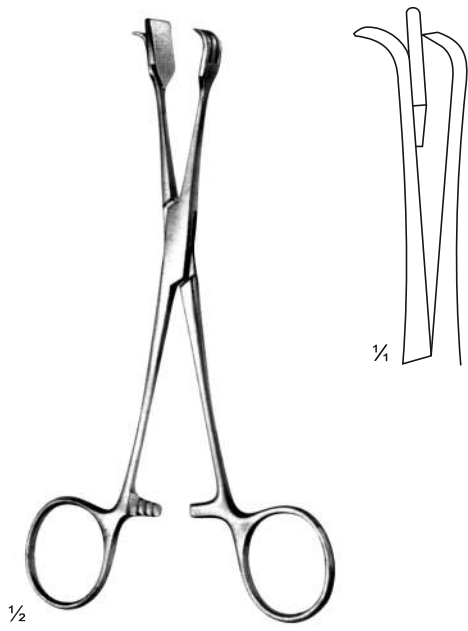

d' Assumpção
HP-339-040
 16 cm

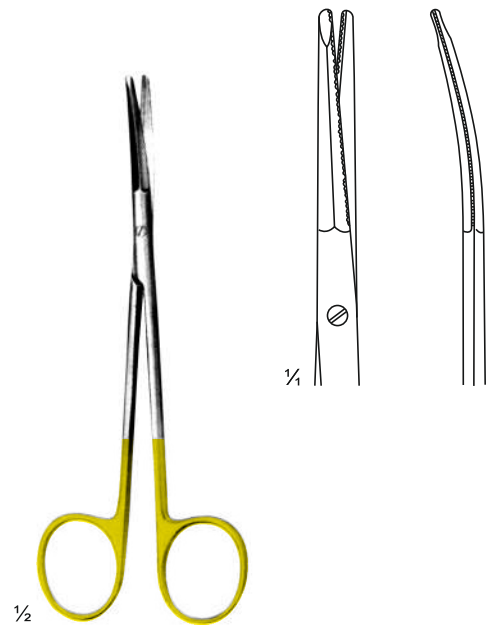

Gergory
HP-339-041
 14.5 cm
 Curved toothed

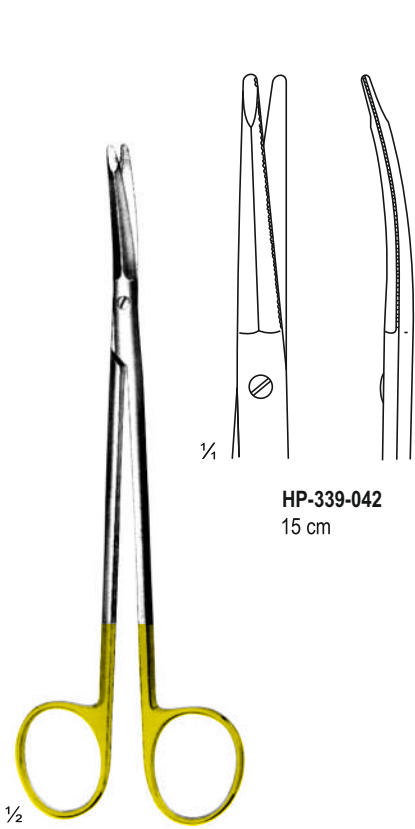

Kaye
HP-339-042 - HP-339-043
 Curved
 one toothed cutting edge

HP-339-042
 15 cm

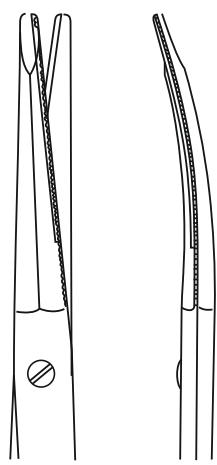

HP-339-043
 18 cm

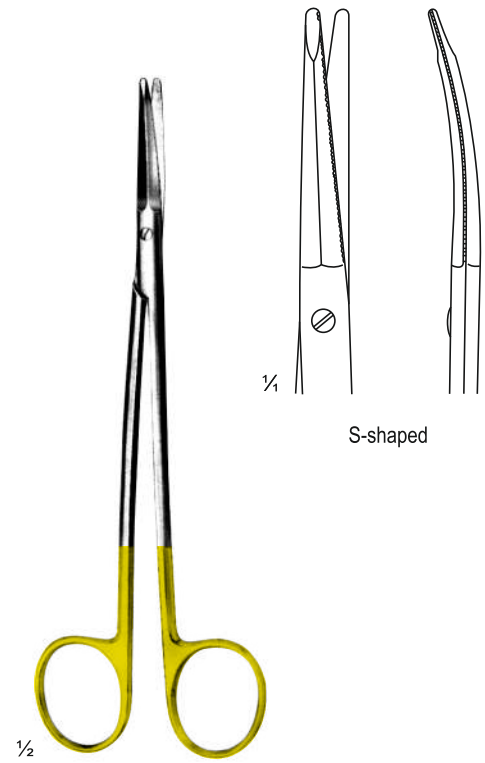

Stells-S
HP-339-044
 18 cm
 Curved
 one toothed cutting edge

S-shaped

Face-Lift Scissors T.C.

Face-Lift-Schere T.C.
Tesoura de Face-Lift T.C.
Face-Lift Scissors T.C.

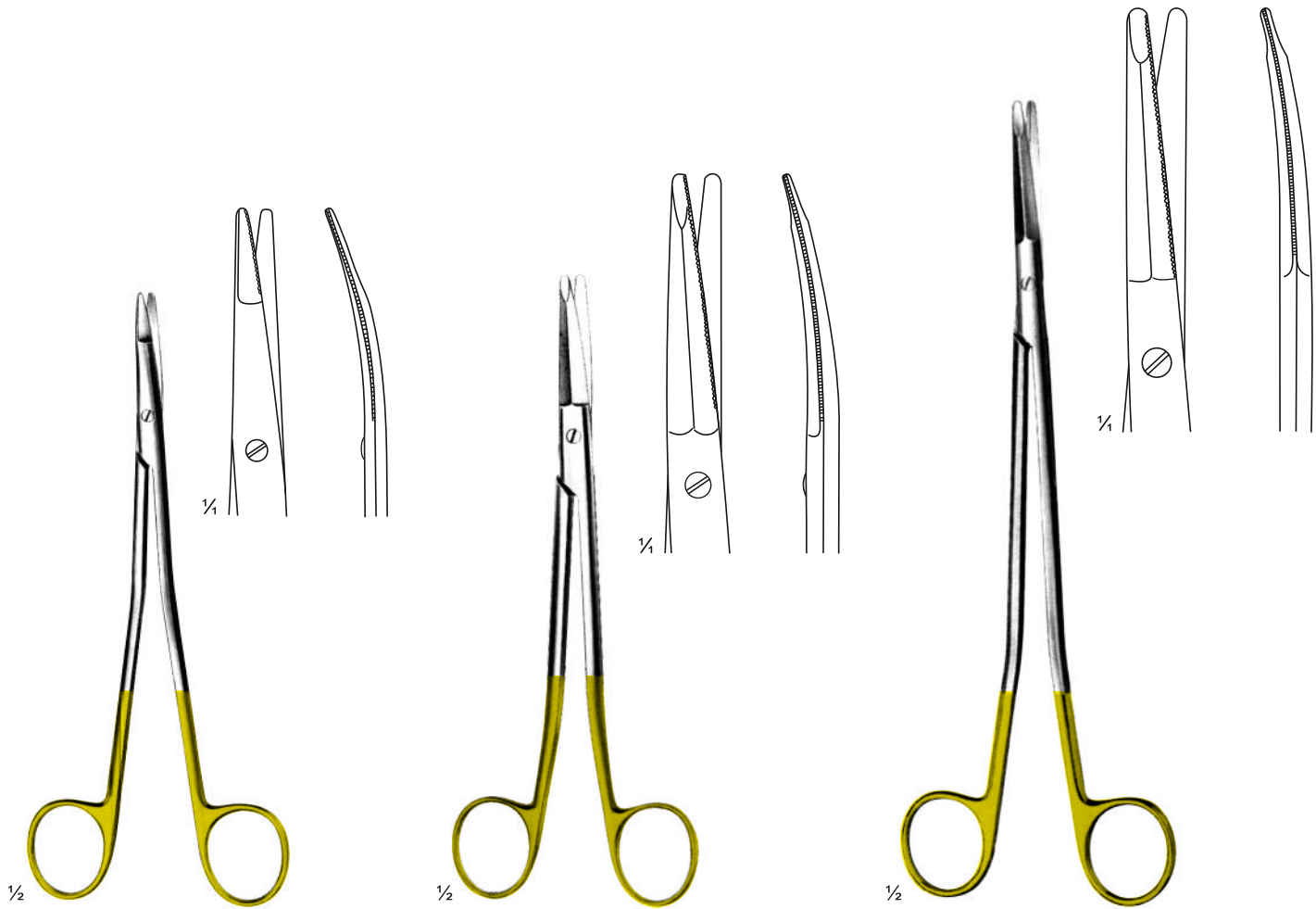

Gorney
HP-340-045
17.5 cm
Curved
One Toothed Cutting Edge

Freeman-Kaye
HP-340-046
18 cm
Curved
One Toothed Cutting Edge

Freeman
HP-340-047
23 cm
Curved
One Toothed Cutting Edge



Stomach, Intestines, Rectum

Magen, Darm, Rektum

Estômago, Intestinos, Reto

Estómago, intestinos, recto

Page 341-355

Intestinal and Tissue Grasping Forceps

Intestinale und Gewebe fassende Zange
Pinça de apreensão intestinal e tecidual
Pinza de agarre intestinal y de tejidos



Allis-Baby
HP-341-001
13 cm

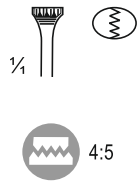

Allis
HP-341-002- HP-341-005
15.5 cm

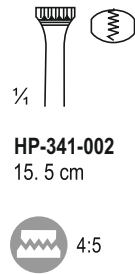

HP-341-002
15.5 cm

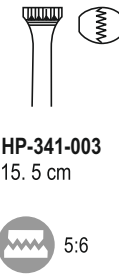

HP-341-003
15.5 cm

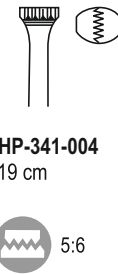

HP-341-004
19 cm

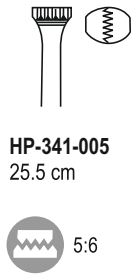

HP-341-005
25.5 cm

Atrauma

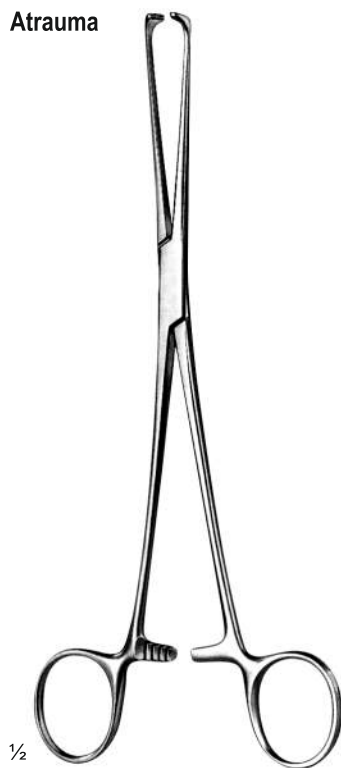

Allis
HP-341-006 - HP-341-009
20 cm

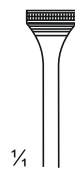

HP-341-006
15.5 cm

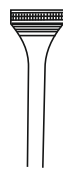

HP-341-007
20 cm



HP-341-008
24.5 cm

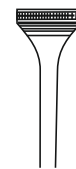

HP-341-009
30 cm

Intestinal and Tissue Grasping Forceps

Intestinale und Gewebe fassende Zange
 Pinça de apreensão intestinal e tecidual
 Pinza de agarre intestinal y de tejidos

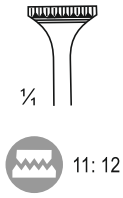

Allis-Adair
 HP-342-010
 16 cm

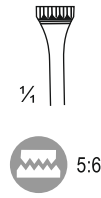

Boys-Allis
 HP-342-011
 15.5 mm

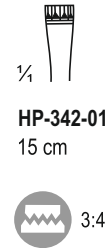
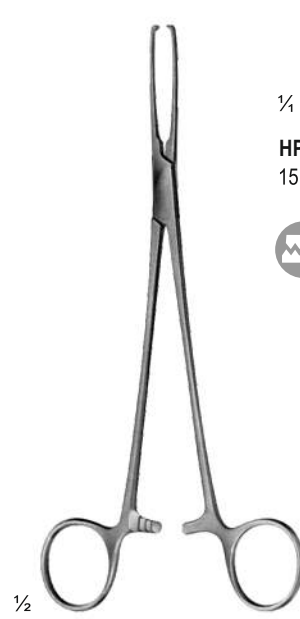

HP-342-012
 15 cm

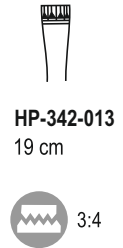

HP-342-013
 19 cm

Judd-Allis
 HP-342-012 - HP-342-013
 15.5 cm

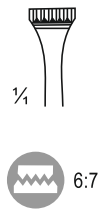
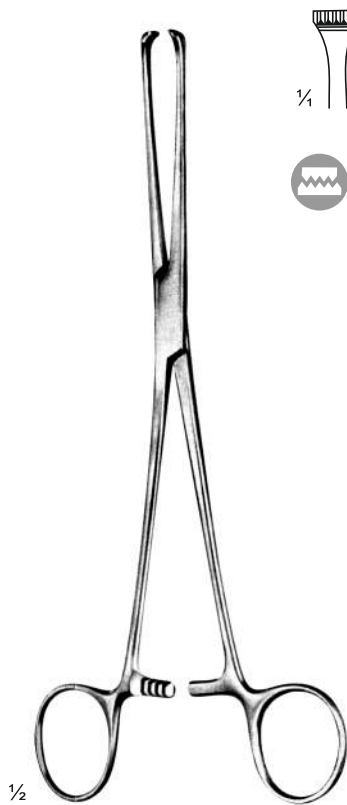

Thoms-Allis
 HP-342-014
 20.5 cm

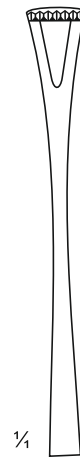
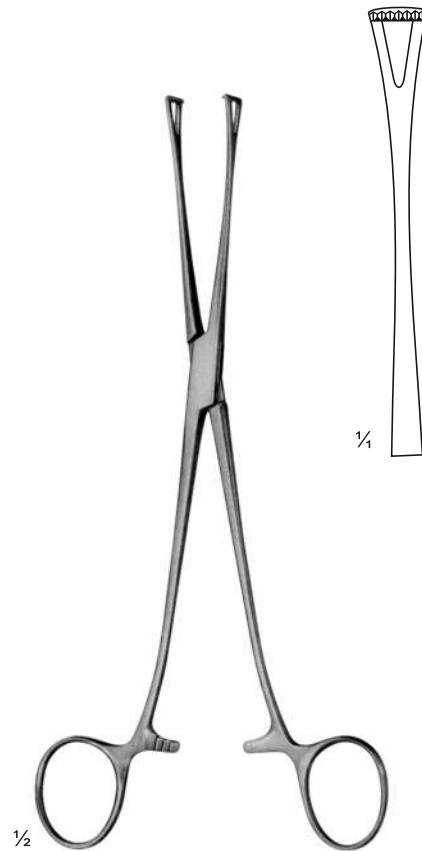

Lockwood
 HP-342-015
 20 cm

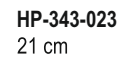
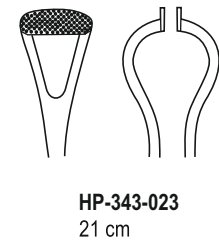
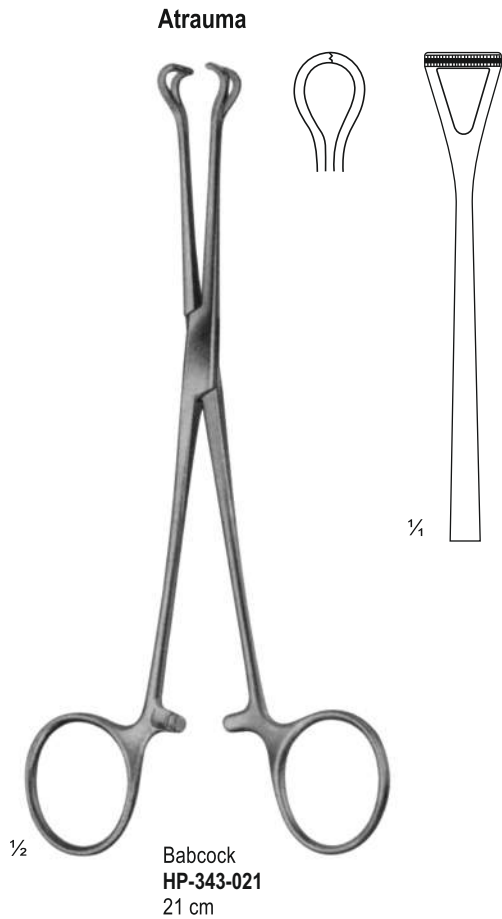
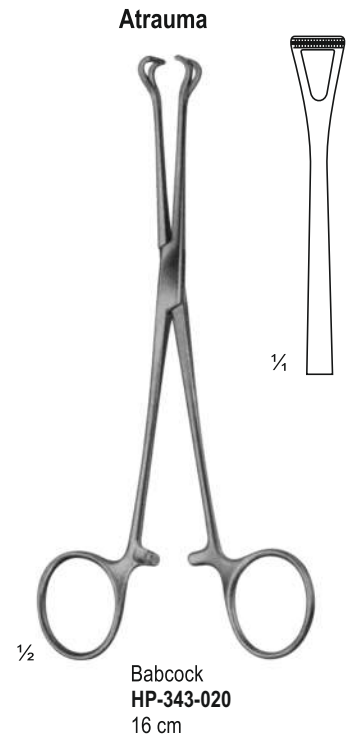
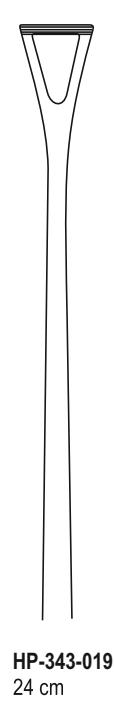
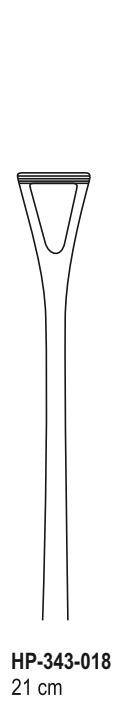
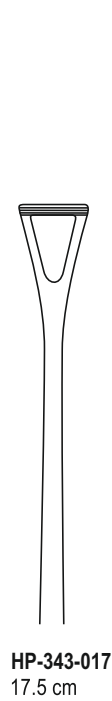

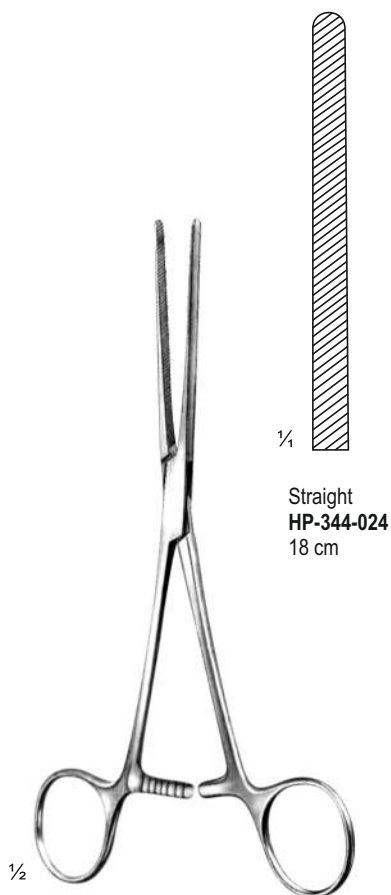

1/4
Straight
HP-344-024
18 cm

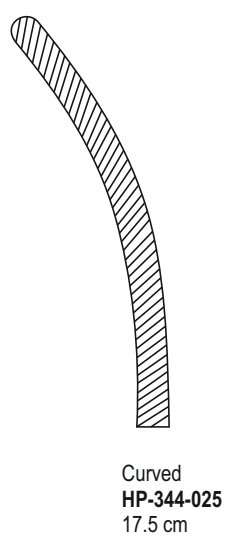

Curved
HP-344-025
17.5 cm



1/4
Straight
HP-344-026
21.5 cm
HP-344-027
23.5 cm

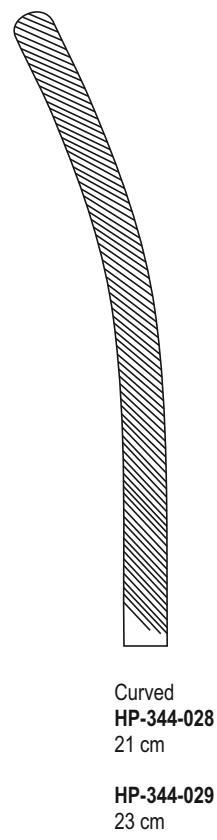

Curved
HP-344-028
21 cm
HP-344-029
23 cm

Doyen-Boby
HP-344-024 - HP-344-025
18 cm

Doyen
HP-344-026 - HP-344-029
18 cm

Intestinal Clamps

Darmklemmen
Grampos Intestinais
Pinzas intestinales

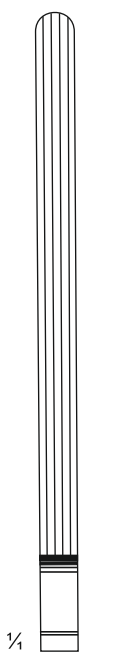
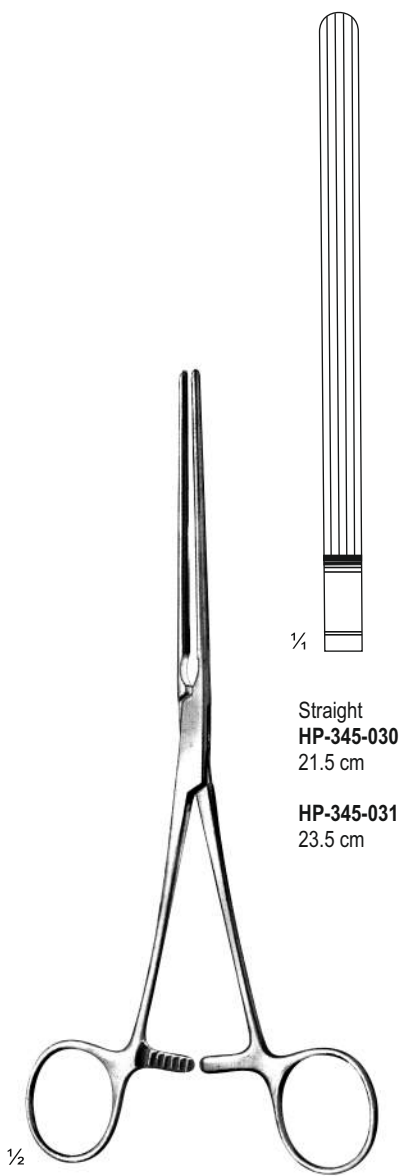

Straight
HP-345-030
21.5 cm

HP-345-031
23.5 cm

Mayo-Robson
HP-345-030 - HP-345-033
21.5 cm

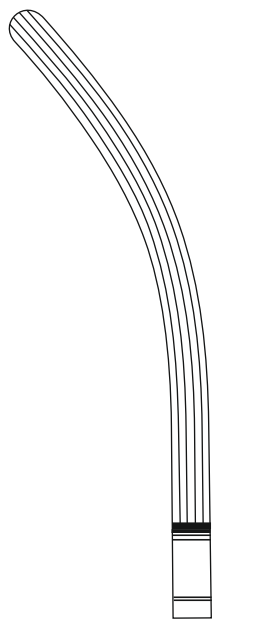

Curved
HP-345-032
21 cm

HP-345-033
23 cm

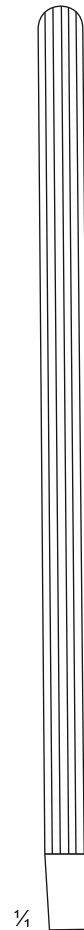
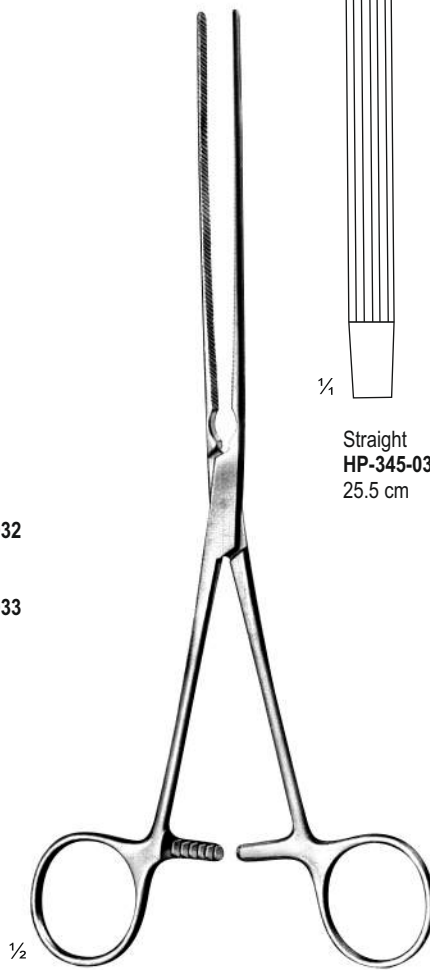

Straight
HP-345-034
25.5 cm

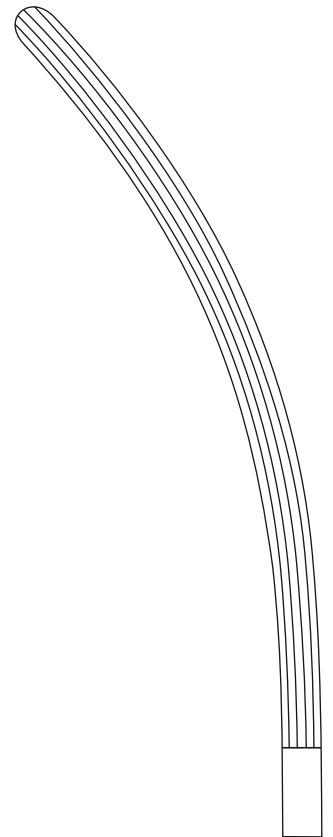

Curved
HP-345-035
24.5 cm

Mayo-Robson
HP-345-034 - HP-345-035
25.5 cm

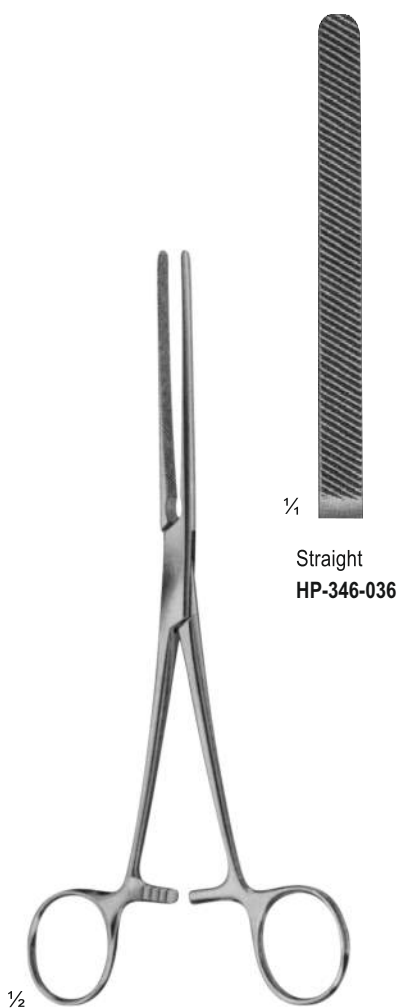

1/4
Straight
HP-346-036

1/2
Hartmann
HP-346-036 - HP-346-037
20 cm
Elastic Blades



Curved
HP-346-037



1/4
Straight
HP-346-038

1/2
Hartmann
HP-346-038 - HP-346-039
20 cm
Atraumatic Blades

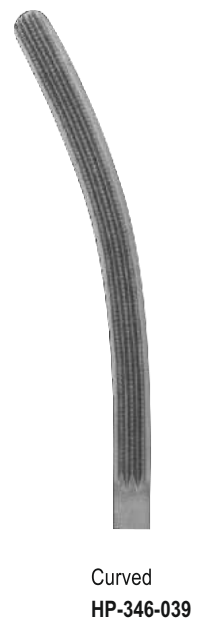

Curved
HP-346-039

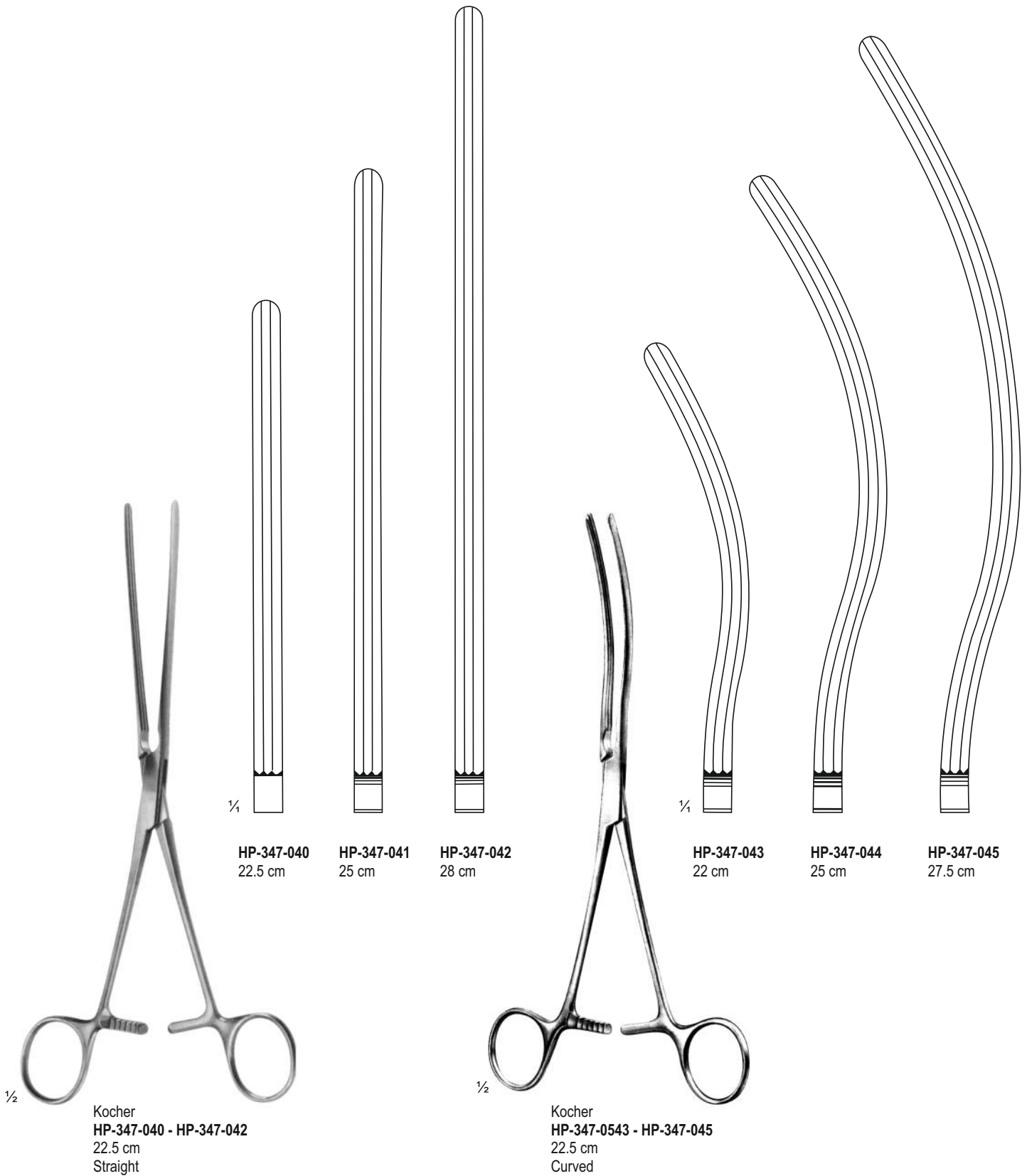

$\frac{1}{2}$
Kocher
HP-347-040 - HP-347-042
22.5 cm
Straight

$\frac{1}{2}$
Kocher
HP-347-0543 - HP-347-045
22.5 cm
Curved

HP-347-040
22.5 cm

HP-347-041
25 cm

HP-347-042
28 cm

HP-347-043
22 cm

HP-347-044
25 cm

HP-347-045
27.5 cm

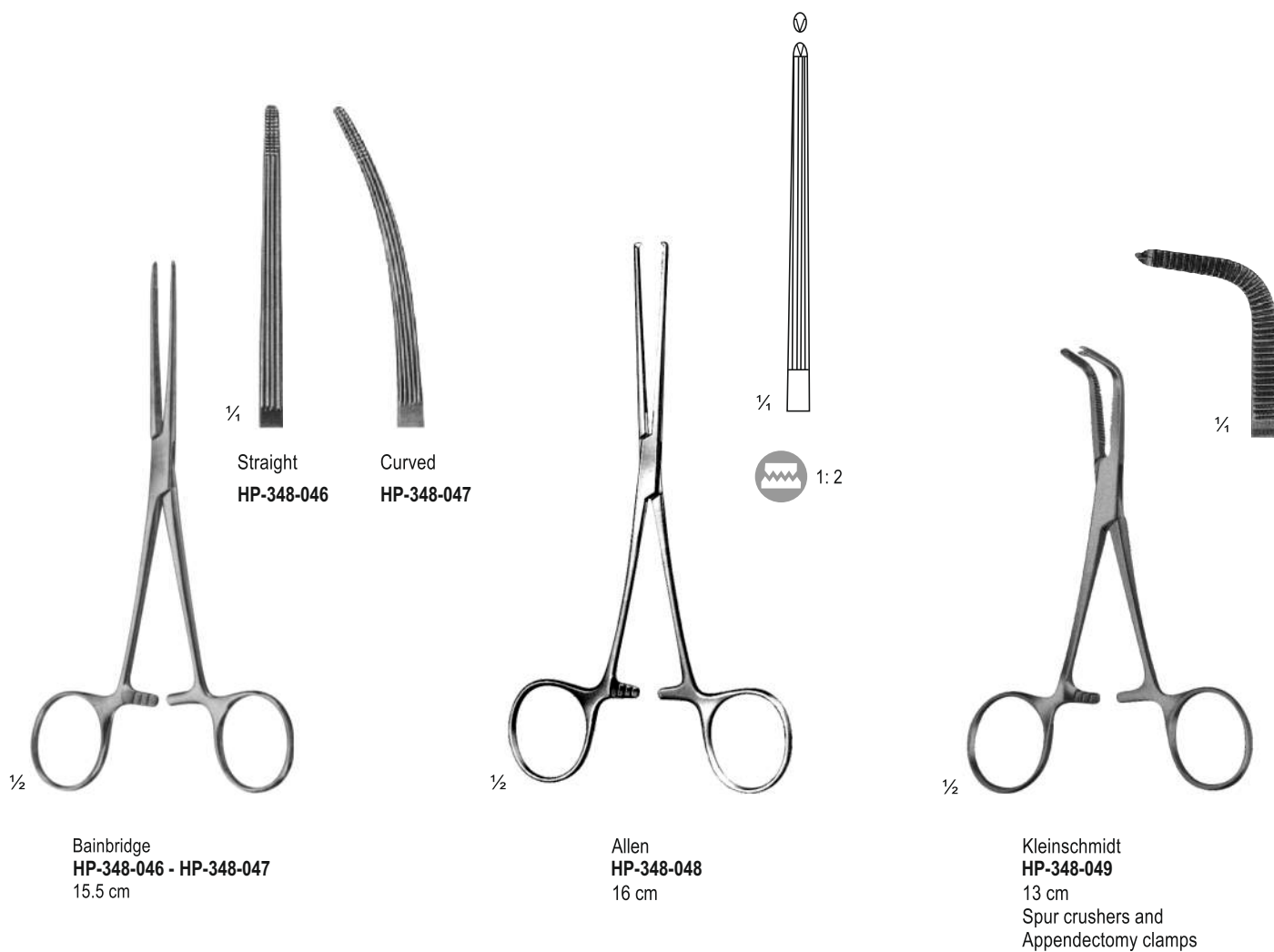

Atrauma



1/2

Doyen-Baby
HP-349-050 - HP-349-054
18 cm
Straight

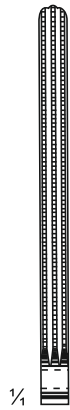

1/4

HP-349-050
14 cm



HP-349-051
17 cm

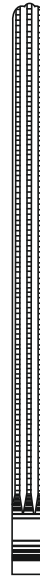

HP-349-052
18.5 cm

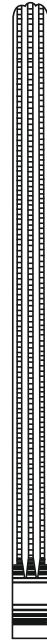

HP-349-053
21.5 cm

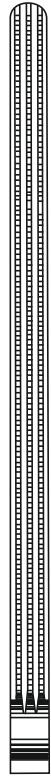

HP-349-054
23.5 cm

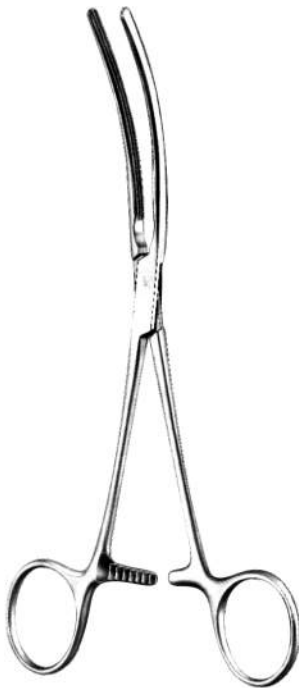

1/2

Doyen-Baby
HP-349-055 - HP-349-059
18 cm
Curved

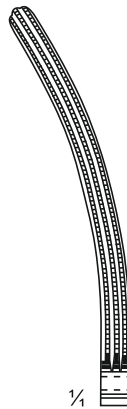

1/4

HP-349-055
13.5 cm

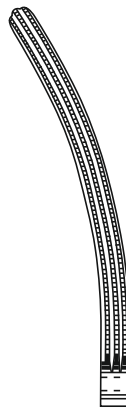

HP-349-056
17 cm

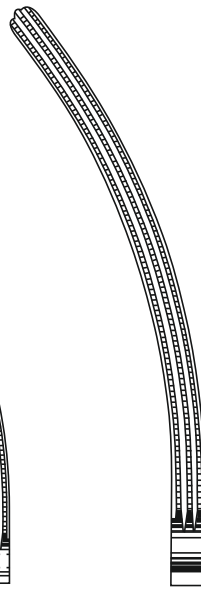

HP-349-057
18 cm

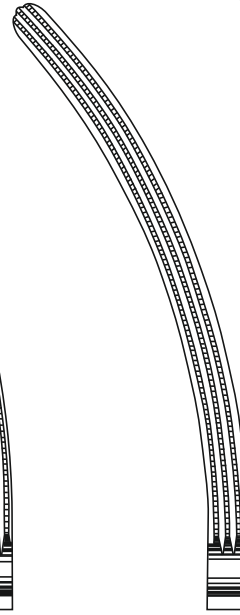

HP-349-058
21 cm

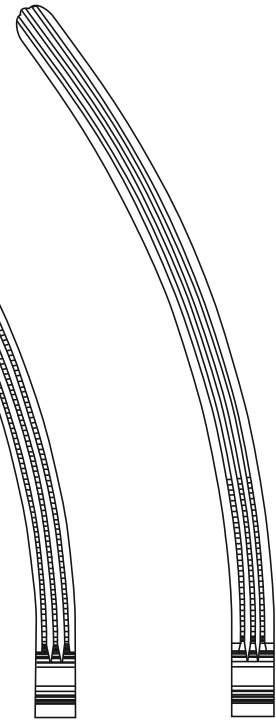

HP-349-059
23 cm



70 x 70 mm

1/2

Killian
HP-350-060 Brass
HP-350-061 Stainless steel
 14.5 cm



70 x 15 mm

1/2

Sims
HP-350-062 Brass
HP-350-063 Stainless steel
 15.5 cm



70 x 15 mm

1/2

Sims
HP-350-064 Brass
HP-350-065 Stainless steel
 15.5 cm



80 x 25 mm

1/2

Pratt
HP-350-066
 20.5 cm
 Brass

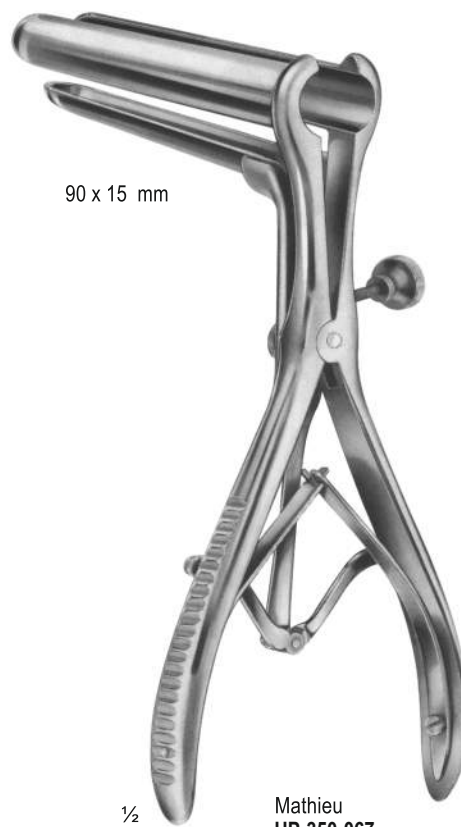

90 x 15 mm

1/2

Mathieu
HP-350-067
 21.5 cm
 Brass

Rectal Specula
Rektale Spekula
Espéculo Retal
Espéculos rectales



1/2

Sims
HP-351-068 - HP-351-071



60 x 20 mm

1/4

HP-351-068
19 cm
For children

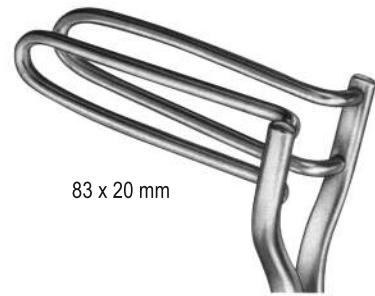

83 x 20 mm

HP-351-069
23.5 cm
For adults

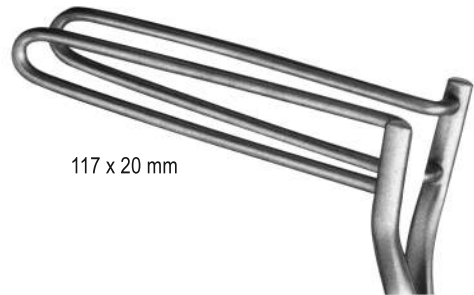

117 x 20 mm

HP-351-070
23.5 cm

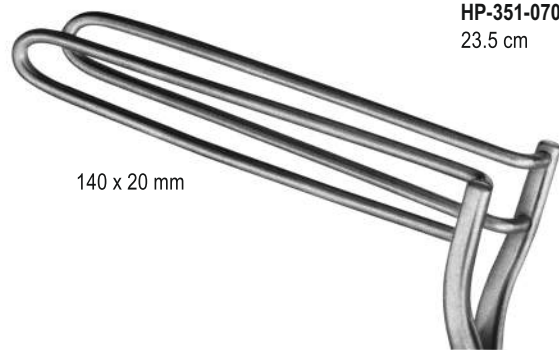

140 x 20 mm

HP-351-071
24.5 cm



Brinkerhoff
HP-352-072 - HP-352-074
HP-352-072 13 - 25 mm Ø / 89 mm
HP-352-073 13 - 25 mm Ø / 102 mm
HP-352-074 19 - 32 mm Ø / 114 mm

½

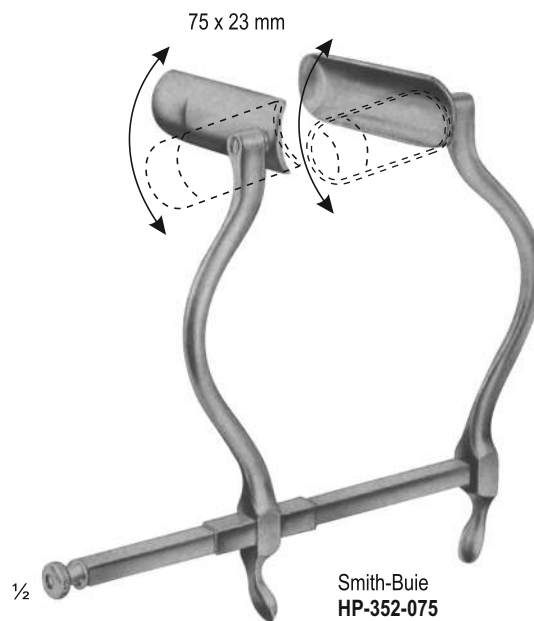

Smith-Buie
HP-352-075
 15 cm

½



Roschke
HP-352-076
 15 cm
 With fibre optic

½



Barr
HP-352-077
 17 cm

½

Anuscope
Anuskop
Ânuscópio
Anuscope



Bensaude
HP-353-078 - HP-353-079

HP-353-078
Working length
70 X 19 mm

HP-353-079
Working length
70 X 22 mm



Hirschmann
HP-353-080 - HP-353-082

HP-353-080
Working length
65 X 16 mm

HP-353-081
Working length
65 X 19 mm

HP-353-082
Working length
65 X 22 mm



Ø 22 mm

1/2

Ives-Fansler
HP-353-083
14.5 cm

Working length
80 mm



Alan-Parks
HP-354-084 - HP-354-090

HP-354-084
 14 cm
 Without F.O. light carrier

HP-354-085
 14 cm
 With F.O. light carrier



HP-354-087
 Wing nut

HP-354-088
 Pair of lateral blades, short, useful length 75 mm

HP-354-089
 Pair of lateral blades, long, useful length 95 mm



HP-354-090
 Central blades, useful length 95 mm

1/4

HP-354-086
 F.O. light carrier

Sphincteroscopes, Hemorrhoidal Ligators

Sphinkteroskope, hämorrhoidale Ligatoren
Sphincteroscopes, Ligadores Hemorrhoidais
Esfincteroscopios, ligadores hemorroidales

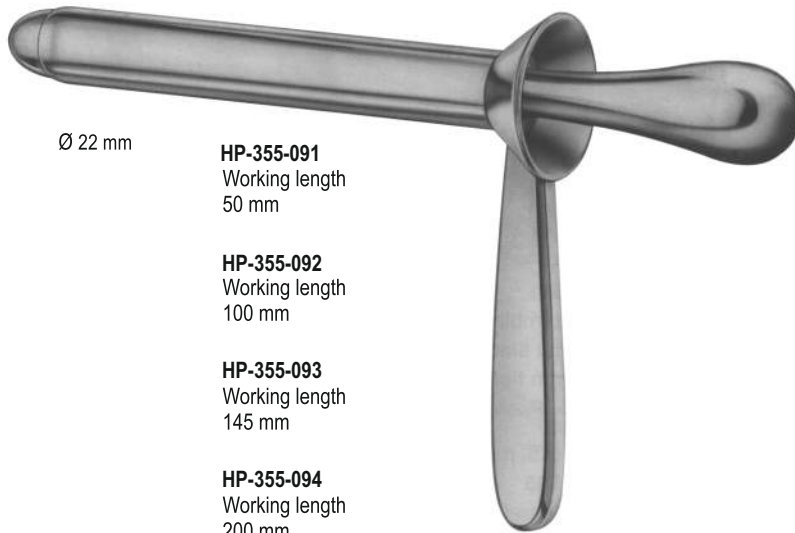

Ø 22 mm

HP-355-091
Working length
50 mm

HP-355-092
Working length
100 mm

HP-355-093
Working length
145 mm

HP-355-094
Working length
200 mm



HP-355-095
Ø 21 mm
Working length
50 mm

HP-355-096
Ø 27 mm
Working length
50 mm

Kelly
HP-355-091 - HP-355-094
Sphincteroscopes

Kelly
HP-355-095 - HP-355-096
Sphincteroscopes



HP-355-097
Loading Cone



Rudd
HP-355-097 - HP-355-099
Hemorrhoidal ligators

HP-355-098
27.5 cm
Complete with loading cone



HP-355-099
Rubber rings
package of 100 pieces



Liver, Gall Bladder, Kidney and Urology

Leber, Gallenblase, Niere und Urologie

Fígado, vesícula biliar, riñón y urología

Hígado, vesícula biliar, riñón y urología

Page 356-366

Kidney Stone Forceps

Nierensteinzange
Pinça de Pedra no Rim
Pinzas de piedra de riñón

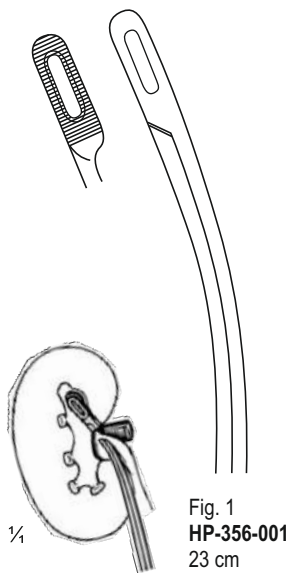

Fig. 1
HP-356-001
23 cm

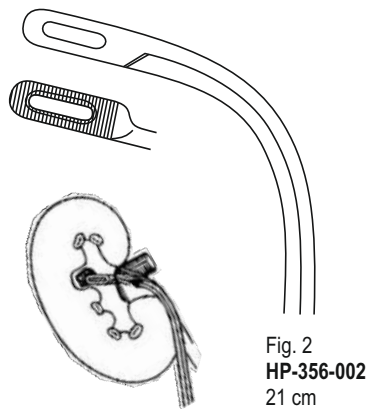

Fig. 2
HP-356-002
21 cm

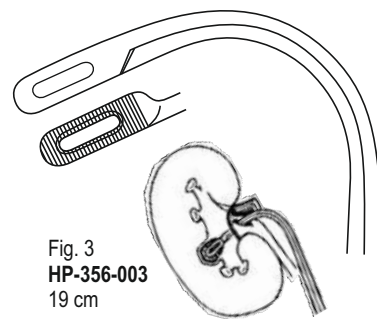

Fig. 3
HP-356-003
19 cm

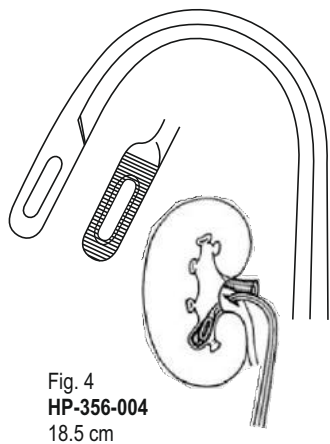

Fig. 4
HP-356-004
18.5 cm

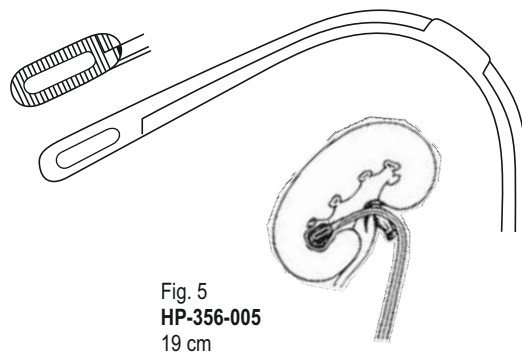

Fig. 5
HP-356-005
19 cm



Randall
HP-356-001 - HP-356-006
23 cm

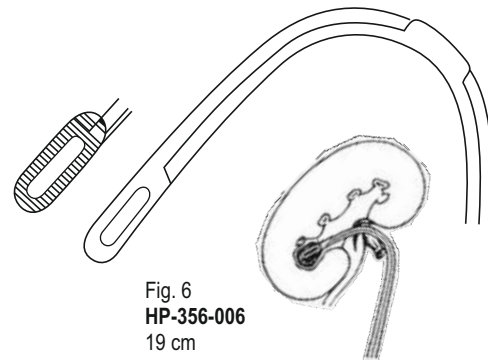

Fig. 6
HP-356-006
19 cm

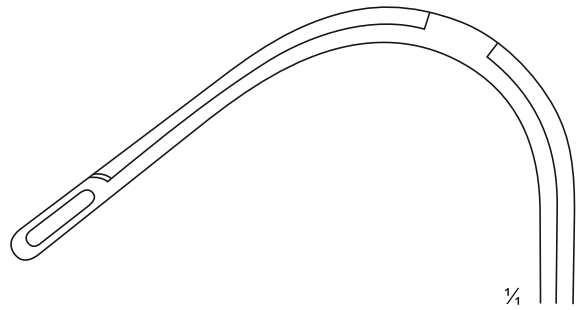

Fig. 1
HP-357-007
23 cm

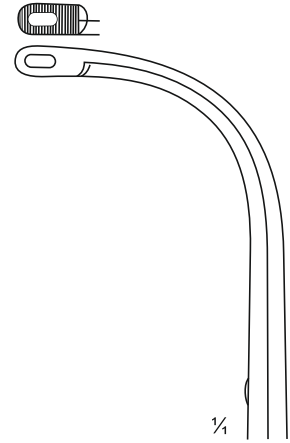

Fig. 1
HP-357-009
16 cm

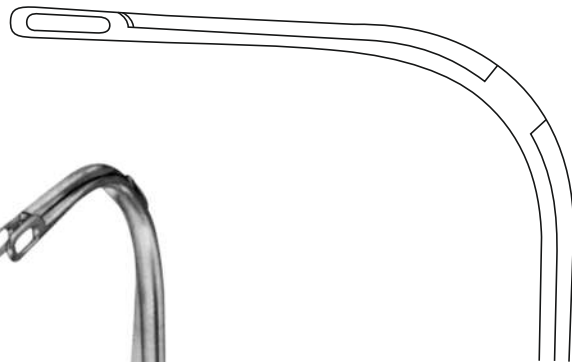

Fig. 2
HP-357-008
24 cm

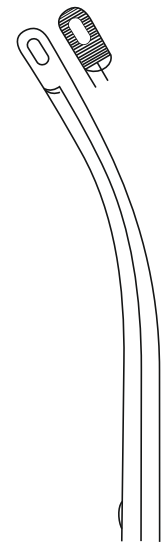
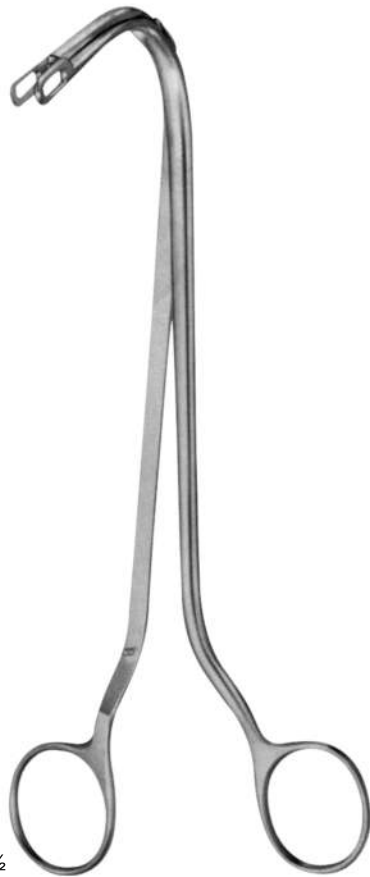

Fig. 2
HP-357-010
17 cm



1/2

Randall
HP-357-007 - HP-357-008
23 cm
Extremely delicate pattern



1/2

Heiming
HP-357-009 - HP-357-010
17 cm
For children

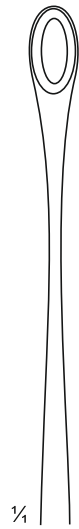

HP-358-011

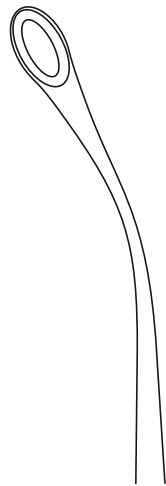

HP-358-012



1/2

Blake
HP-358-011 - HP-358-012
21 cm

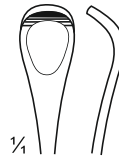

1/4



1/2

Mayo-Blake
HP-358-013
21 cm
Straight

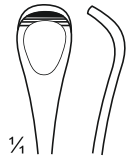

1/4



1/2

Mayo-Blake
HP-358-014
21 cm
Angled

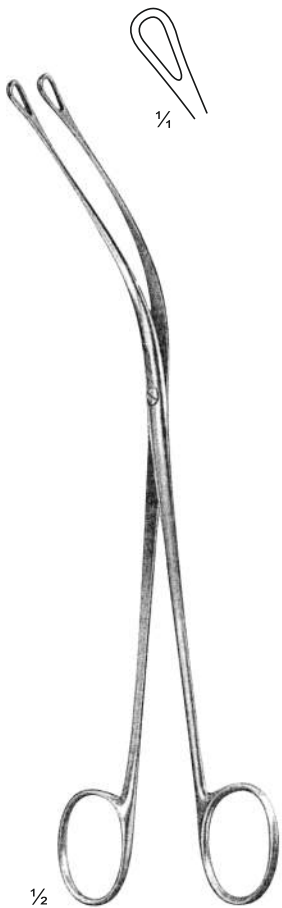

Mixer
 HP-359-015
 22 cm



Desjardins
 HP-359-016 - HP-359-017
 23 cm



Fig. 1
 HP-359-016

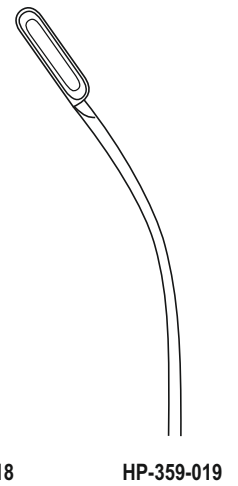

Fig. 2
 HP-359-017



Desjardins
 HP-359-018 - HP-359-019
 23 cm
 very slender pattern

1/4
 HP-359-018



HP-359-019

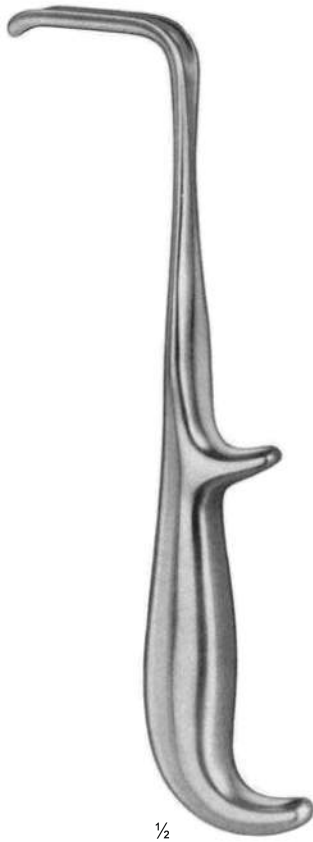
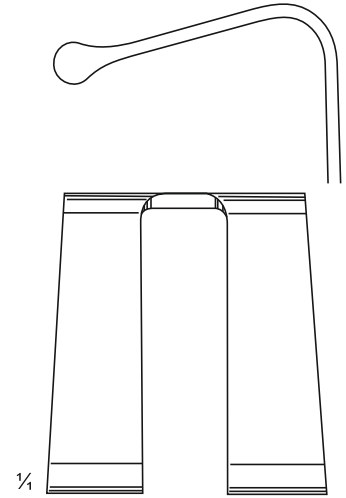
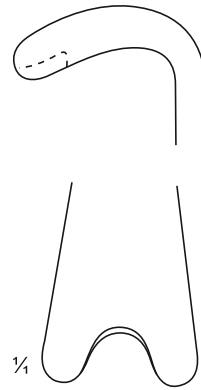
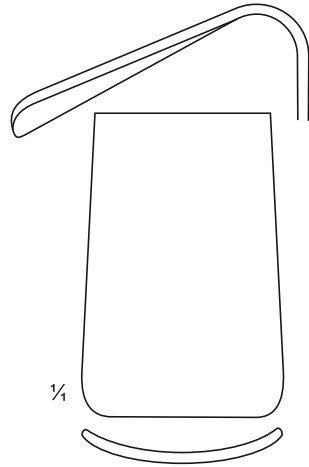
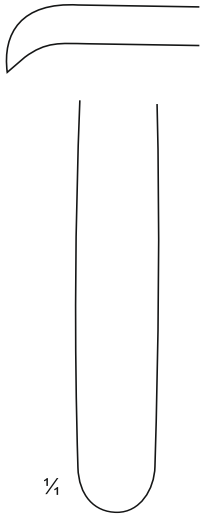

Young
HP-360-020
22 cm

Young
HP-360-021
22 cm

Young
HP-360-022
21.5 cm

Young
HP-360-023
23 cm

Bladder Spatula, Bladder Retractors, Cord Tissue Hook

Blasenspatel, Blasen-Retraktoren, Schnur-Gewebe-Haken
 Espátula da bexiga, retratores da bexiga, gancho do tecido do cabo
 Espátula vesical, retractoros de vejiga, gancho de tecido del cordón



Legueu
 HP-361-024
 24 cm
 Blade 35 mm
 Bladder spatula



Kocher
 HP-361-025
 26 cm
 Bladder retractors
 blade 56 mm



Kocher
 HP-361-026
 26 cm
 Bladder retractors
 Blade 67 mm



Spermatic
 HP-361-027
 16 cm
 Cord tissue hook

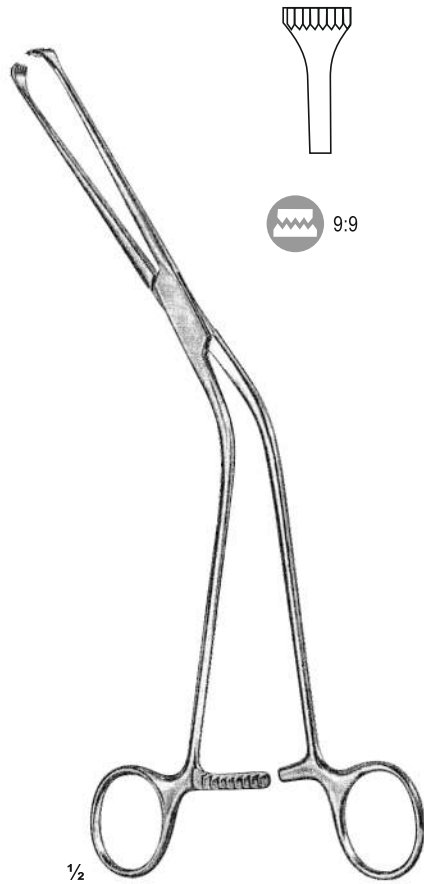

Millin
HP-362-028
22 cm
Capsule forceps



Millin
HP-362-029
24 cm
Ligature carrying forceps



Legueu
HP-363-030
 Center blade
 80 x 31 mm



Judd-Masson
HP-363-031
 Spreading
 120 mm



Judd-Masson
HP-363-032
 Self-retaining with swivel blade 70 x 25 mm
 and center blade 70 mm deep
 opening 10 cm



Judd-Masson
HP-363-033
 Self-retaining with swivel blade,
 cross bar 16.8 cm, Blade depth 6.9 cm.
 Arm length 13 cm

Bladder Retractors

Blasen-Retraktoren
Retratores da Bexiga
Retradores de vejiga

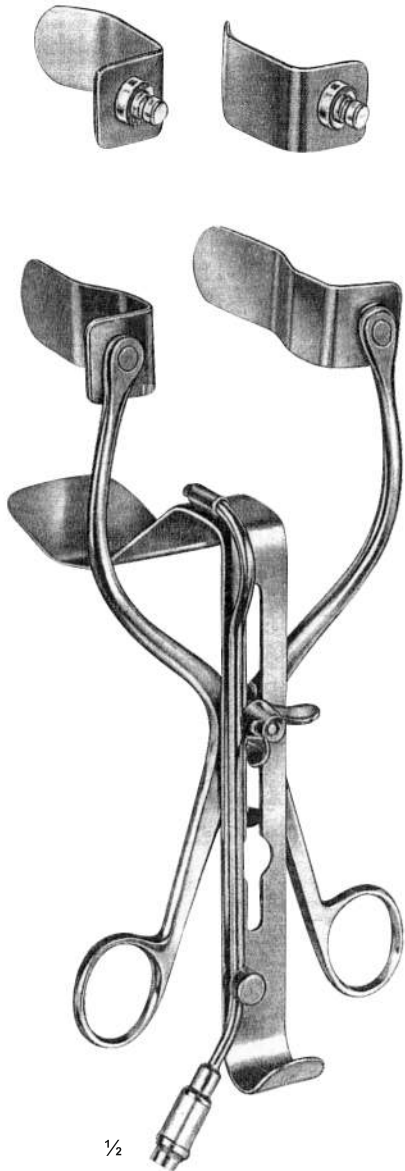

Millin
HP-364-034
complete, with 2 pairs of lateral
blades 57 x 25 mm and 80 x 25 mm,
and 1 central blade 120 X 45 mm,
without F.O. carrier

Millin
HP-364-039
complete, with 2 pairs of lateral
blades 57 x 25 mm and 80 x 25 mm,
and 1 central blade 120 X 45 mm,
with F.O. carrier

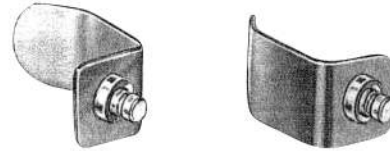

HP-364-035
Lateral blades
57 x 25 mm

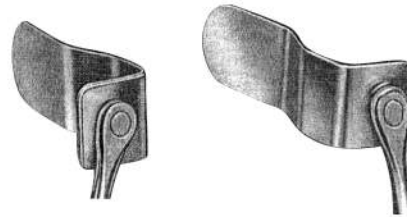

HP-364-036
Lateral blades
80 x 25 mm

HP-364-037
Central Blade, **without** F.O. carrier

HP-364-038
Fiber Optic Light Carrier





Knutson
HP-365-040
 Urethrography Instrument

Knutson-Koch
HP-365-041
 Cone, only

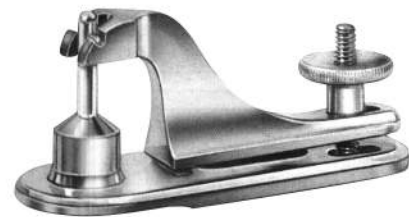

HP-365-042 - HP-365-048
 Circumcision gomco clamp

- HP-365-042** Ø 8 mm
- HP-365-043** Ø 11 mm
- HP-365-044** Ø 13 mm
- HP-365-045** Ø 16 mm
- HP-365-046** Ø 21 mm
- HP-365-047** Ø 26 mm
- HP-365-048** Ø 32 mm

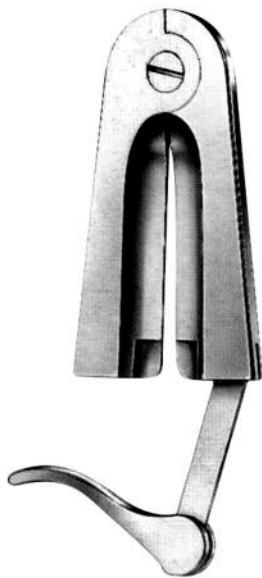

Mogen
HP-365-049
 7.5 cm
 Circumcision clamp



Stockmann
HP-365-050
 8 cm
 Penis clamp



Strauss
HP-365-051
 11 cm
 Penis clamp

HP-365-052
 1 pair of flexible tubes only



Gynecology

Gynäkologie
Ginecologia
Ginecología

Page 367-389

Vaginal Specula

Vaginale Spekula
Vaginale Spekula
Vaginale Spekula



Collin
HP-367-001
53 x 10 mm
For children



Collin
HP-367-002
95/85 x 18 mm



Collin
HP-367-003 80 x 30 mm
HP-367-004 100x 35 mm
HP-367-005 110 x 40 mm



Cusco
HP-367-006 90 x 22 mm Small
HP-367-007 100 x 25 mm Medium
HP-367-008 110 x 27 mm Large
Swiss pattern, side screw



Cusco
HP-367-009 90 x 22 mm Small
HP-367-010 100 x 25 mm Medium
HP-367-011 110 x 27 mm Large
Swiss pattern, center screw



Cusco
HP-367-012 95 x 30 mm Small
HP-367-013 105 x 33 mm Medium
HP-367-014 110 x 35 mm Large
German pattern, side screw



Cusco
HP-367-015 95 x 30 mm Small
HP-367-016 105 x 33 mm Medium
HP-367-017 110 x 35 mm Large
German pattern, center screw



Cusco
HP-368-018 Side screw
HP-368-019 Center screw
 75 x 17 mm
 Virgin

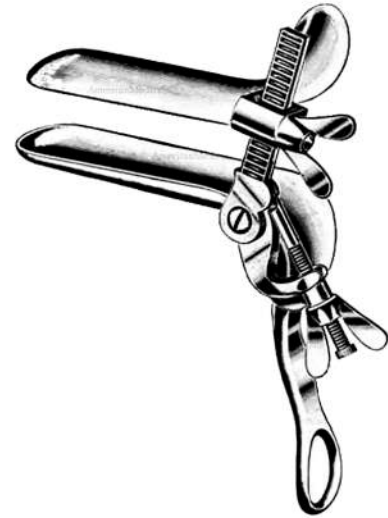

Trelat
HP-368-020 85 x 33 mm
HP-368-021 95 x 35 mm
HP-368-022 115 x 43 mm

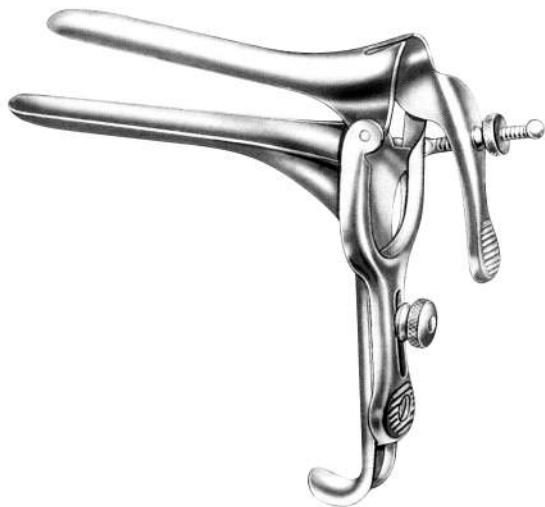

Graves
HP-368-023 75 x 20 mm
HP-368-024 95 x 30 mm
HP-368-025 105 x 33 mm

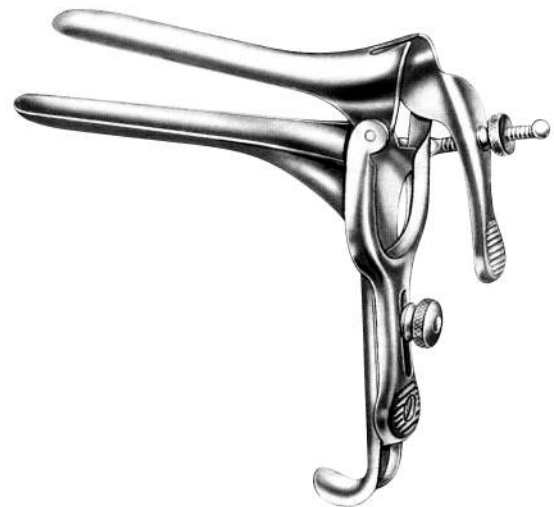

Pederson
HP-368-026 75 x 13 mm
HP-368-027 100 x 22 mm
HP-368-028 120 x 25 mm

Vaginal Specula
Vaginale Spekula
Vaginale Spekula
Vaginale Spekula



Semm
HP-369-029 - HP-369-030
HP-369-029 100 x 20-25 mm
HP-369-030 100 x 27-35 mm



Seyffert
HP-369-031 - HP-369-032
HP-369-031 100 x 24 mm
HP-369-032 110 x 32 mm
23 cm



Guttman
HP-369-033
90 x 35 mm



Sims
HP-370-034 - HP-370-036
HP-370-034 65 x 25 mm
HP-370-035 70 x 30 mm
HP-370-036 85 x 35 mm
 Set of 3



Jackson
HP-370-037 - HP-370-039
HP-370-037 75 x 38 mm
HP-370-038 90 x 38 mm
HP-370-039 100 x 38 mm
 Vaginal retractors



Kristeller
HP-370-040 - HP-370-042
HP-370-040 Fig.1 70 x 27 mm
HP-370-041 Fig.2 80 x 30 mm
HP-370-042 Fig.3 90 x 36 mm
 Vaginal Speculum



Kristeller
HP-370-043 - HP-370-045
HP-370-043 Fig. 1 (20-132-01 & 20-136-01)
HP-370-044 Fig. 2 (20-132-02 & 20-136-02)
HP-370-045 Fig. 3 (20-132-03 & 20-136-03)
 Speculum /retractors (set)
 Vaginal retractor (Set)



Kristeller
HP-370-046 - HP-370-048
HP-370-046 Fig. 1 75 x 23 mm
HP-370-047 Fig. 2 85 x 26 mm
HP-370-048 Fig. 3 100 x 32 mm
 Vaginal retractors



Kristeller
HP-370-049 - HP-370-050
HP-370-049 Fig. 1 105 x 18 mm
HP-370-050 Fig. 2 110 x 21 mm
 Speculum slender pattern

Vaginal Specula, Vaginal Retractors
Vaginale Spekula, Vaginale Retraktoren
Espécua Vaginal, Retratores Vaginais
Espéculos vaginales, retractoros vaginales



Kristeller
HP-371-051 - HP-371-052
HP-371-051 Fig. 1 110 x 14 mm
HP-371-052 Fig. 2 115 x 17 mm
Vaginal retractor
Slender pattern



Kristeller
HP-371-053 - HP-371-054
HP-371-053 Fig. 1 (20-138-01 & 20-140-01)
HP-371-054 Fig. 2 (20-138-02 & 20-140-02)
Speculum / retractor (set)
slender pattern



Kristeller
HP-371-055 - HP-371-057
HP-371-055 Fig. 1 105 x 26 mm
HP-371-056 Fig. 2 105 x 28 mm
HP-371-057 Fig. 3 105 x 33 mm
Flat speculum



Kallmorgen
HP-372-058 - HP-372-059
HP-372-058 Fig. 1 70 x 37 mm
HP-372-059 Fig. 2 90 x 37 mm
 Vaginal retractor



Kallmorgen
HP-372-060 - HP-372-031
HP-372-060 Fig. 1 (20-156-01 & 20-158-01)
HP-372-061 Fig. 2 (20-156-02 & 20-158-02)
 speculum / retractor (Set)



Doyen
HP-372-062 Fig. 1 58 x 35 mm
HP-372-063 Fig. 2 88 x 35 mm
HP-372-064 Fig. 3 118 x 35 mm

HP-372-065 Fig. 1 60 x 47 mm
HP-372-066 Fig. 2 78 x 47 mm
HP-372-067 Fig. 3 120 x 47 mm
HP-372-068 Fig. 4 165 x 47 mm

HP-372-069 Fig. 1 55 x 60 mm
HP-372-070 Fig. 2 85 x 60 mm
HP-372-071 Fig. 3 115 x 60 mm
 Vaginal speculum slightly concave

Vaginal Specula, Vaginal Retractors

Vaginale Spekula, Vaginale Retraktoren
Espécula Vaginal, Retratores Vaginais
Espéculos vaginales, retractoros vaginales



56 x 13 mm

Braun
HP-373-072
18 cm
Vaginal speculum

½



60 x 10 mm

Braun
HP-373-073
18 cm
Vaginal speculum

½



95 x 17 - 30 mm

Mathieu
HP-373-074
21 cm
Speculum for
children and virgins

½



95 x 17-26 mm

Mathieu
HP-373-075
21 cm
Vaginal retractor
for children and virgins

½

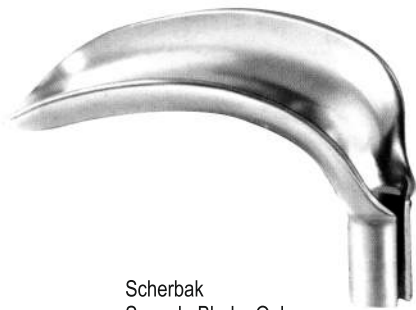

Scherbak
Specula Blade, Only

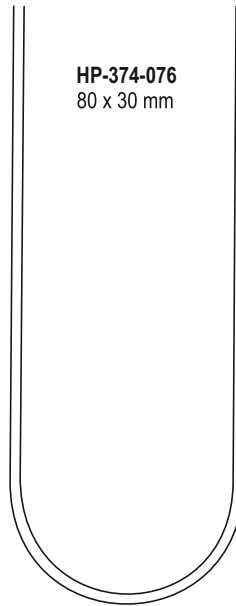

HP-374-076
80 x 30 mm

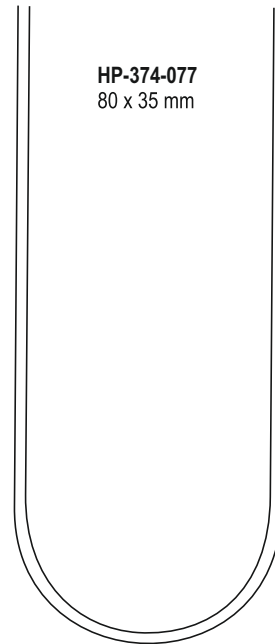

HP-374-077
80 x 35 mm

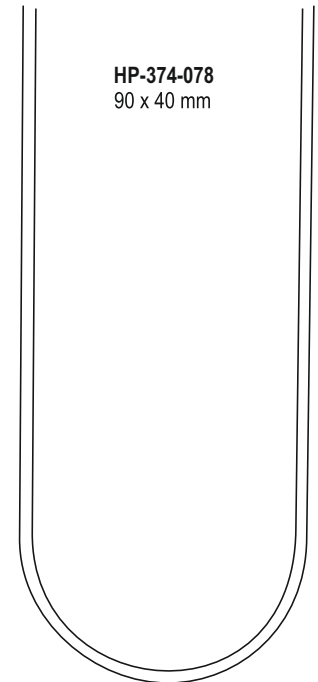

HP-374-078
90 x 40 mm



Scherbak
Specula Blade, Only



HP-374-079
62 x 40 - 60 mm

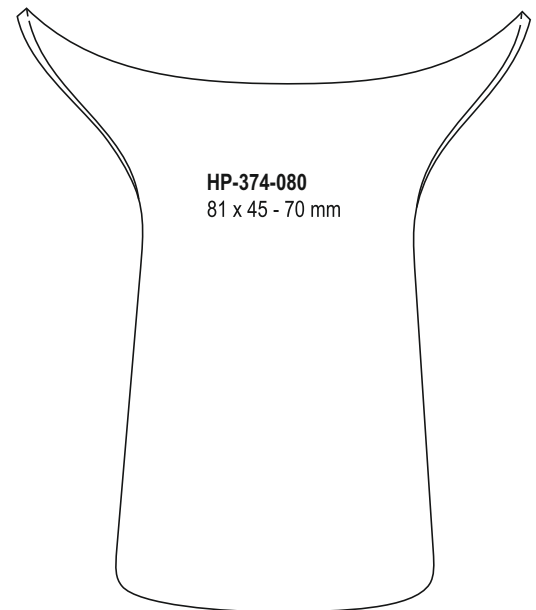

HP-374-080
81 x 45 - 70 mm

Scherbak
HP-374-081

Uterine Dilators
Gebärmutter-Dilatatoren
Dilatadores Uterinos
Dilatadores uterinos

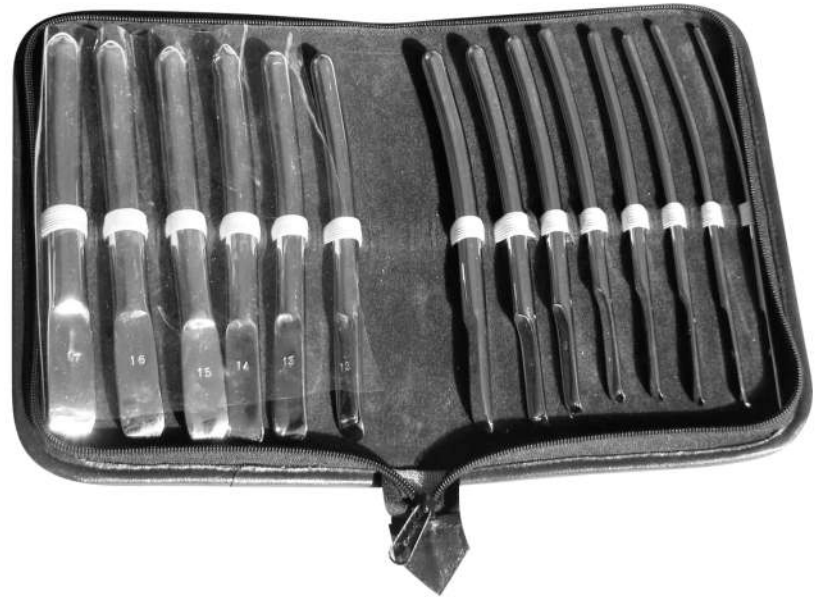

1/2

1 mm	HP-375-082	1.5 mm	HP-375-108
2 mm	HP-375-083	2.5 mm	HP-375-109
3 mm	HP-375-084	3.5 mm	HP-375-110
4 mm	HP-375-085	4.5 mm	HP-375-111
5 mm	HP-375-086	5.5 mm	HP-375-112
6 mm	HP-375-087	6.5 mm	HP-375-113
7 mm	HP-375-088	7.5 mm	HP-375-114
8 mm	HP-375-089	8.5 mm	HP-375-115
9 mm	HP-375-090	9.5 mm	HP-375-116
10 mm	HP-375-091	10.5 mm	HP-375-117
11 mm	HP-375-092	11.5 mm	HP-375-118
12 mm	HP-375-093	12.5 mm	HP-375-119
13 mm	HP-375-094	13.5 mm	HP-375-120
14 mm	HP-375-095	14.5 mm	HP-375-121
15 mm	HP-375-096	15.5 mm	HP-375-122
16 mm	HP-375-097	16.5 mm	HP-375-123
17 mm	HP-375-098	17.5 mm	HP-375-124
18 mm	HP-375-099		
19 mm	HP-375-100		
20 mm	HP-375-101		
21 mm	HP-375-102		
22 mm	HP-375-103		
23 mm	HP-375-104		
24 mm	HP-375-105		
25 mm	HP-375-106		
26 mm	HP-375-107		

HP-375-125

set of 14 pieces (full sizes) from 4 to 17 mm without pouch

HP-375-126

set of 14 pieces (full sizes) from 4 to 17 mm in pouch

HP-375-127

set of 26 pieces (full sizes) from 1 to 26 mm without pouch

HP-375-128

pouch only, for \varnothing 4-7 mm

HP-375-129

set complete, packed in pouch

Hegar
HP-375-082 - HP-375-124
18.5 cm



1/2

HP-376-130	1.0 / 2.0 mm
HP-376-131	3.0 / 4.0 mm
HP-376-132	5.0 / 6.0 mm
HP-376-133	7.0 / 8.0 mm
HP-376-134	9.0 / 10.0 mm
HP-376-135	11.0 / 12.0 mm
HP-376-136	13.0 / 14.0 mm
HP-376-137	15.0 / 16.0 mm
HP-376-138	17.0 / 18.0 mm
HP-376-139	19.0 / 20.0 mm
HP-376-140	21.0 / 22.0 mm
HP-376-141	23.0 / 24.0 mm
HP-376-142	25.0 / 26.0 mm

Hegar
HP-376-130 - HP-376-142
20 cm



Hegar
HP-376-143
set of 8 pieces from 3/4 to 17/18 mm packed in pouch

Uterine Dilators
Gebärmutter-Dilatatoren
Dilatadores Uterinos
Dilatadores uterinos



1/2

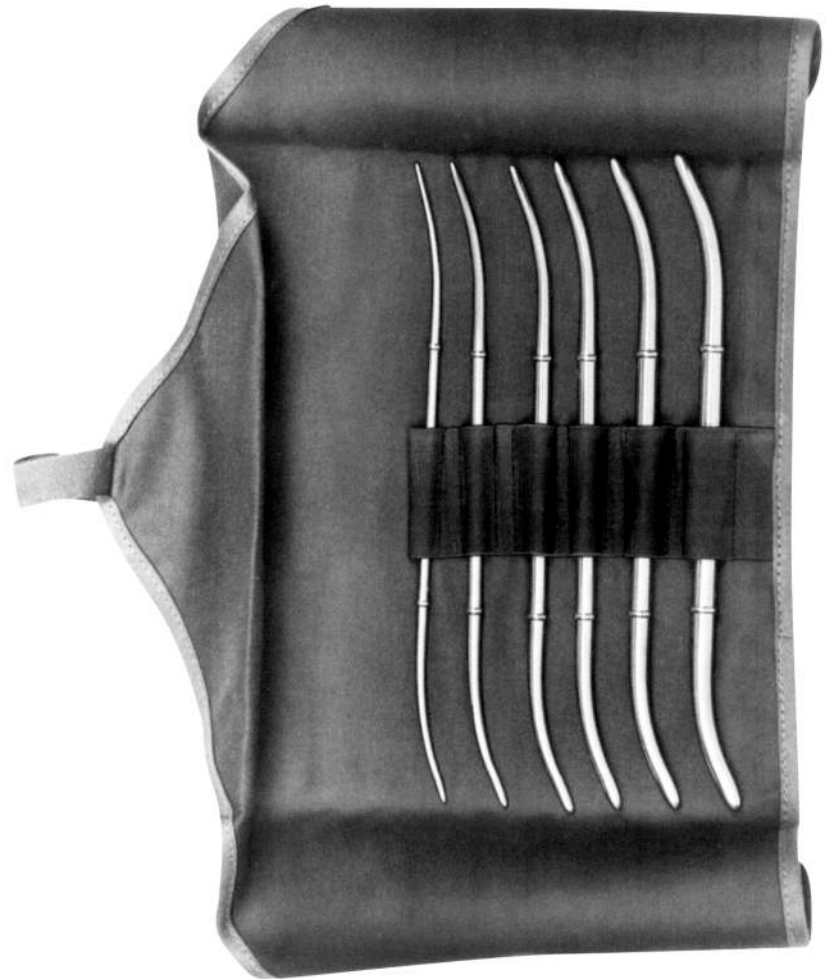

Hank
HP-377-144 - HP-377-149
26.5 cm
American scaler

Hank
HP-377-150
Set of 6 piezas in boilable canvas roll

	Fig.	mm
HP-377-144	9 / 10	4.5 / 5.0
HP-377-145	11 / 12	5.5 / 6.0
HP-377-146	13 / 14	6.5 / 7.0
HP-377-147	15 / 16	7.5 / 8.0
HP-377-148	17 / 18	8.5 / 9.0
HP-377-149	19 / 20	9.5 / 10.0

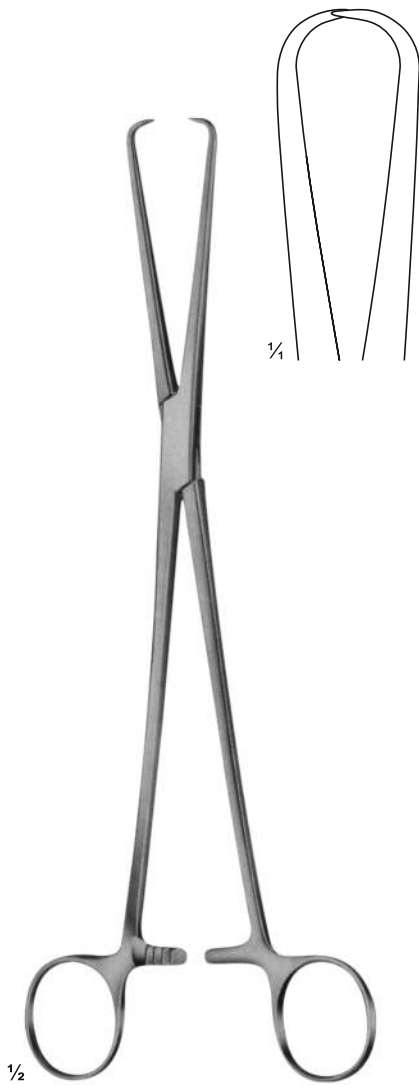

Schröder
 HP-378-151
 25.5 cm

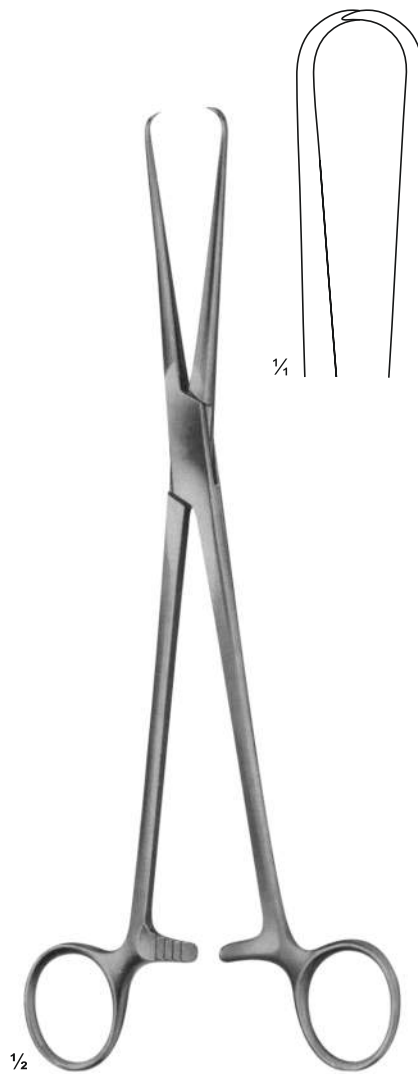

Pozzi
 HP-378-152
 25.5 cm
 Heavy type

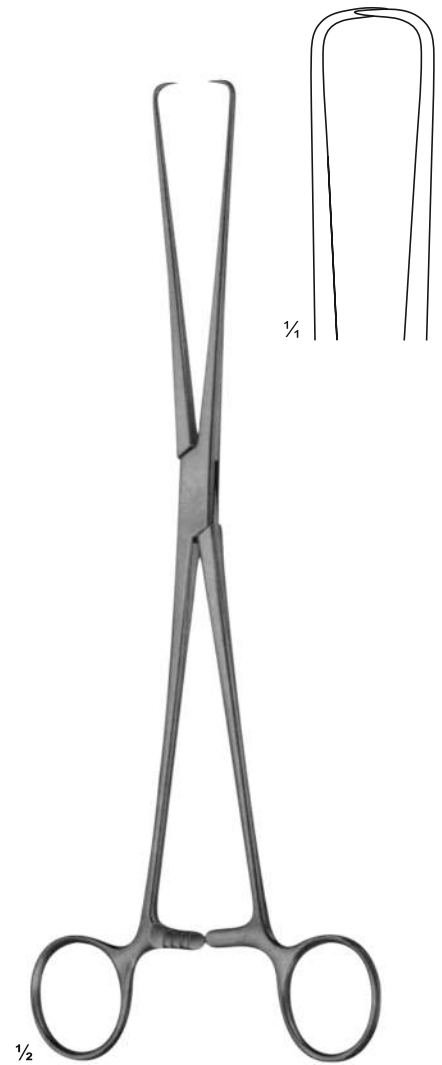

Braun
 HP-378-153
 26 cm

Amniotome, Uterine Tenaculum Forceps
Amniotom, Uterine Tenaculum Pinzette
Amniotome, fórceps de tenaculum uterino
Amniotome, fórceps del tenáculo uterino



Beacham
HP-379-154
26 cm
Amniotome

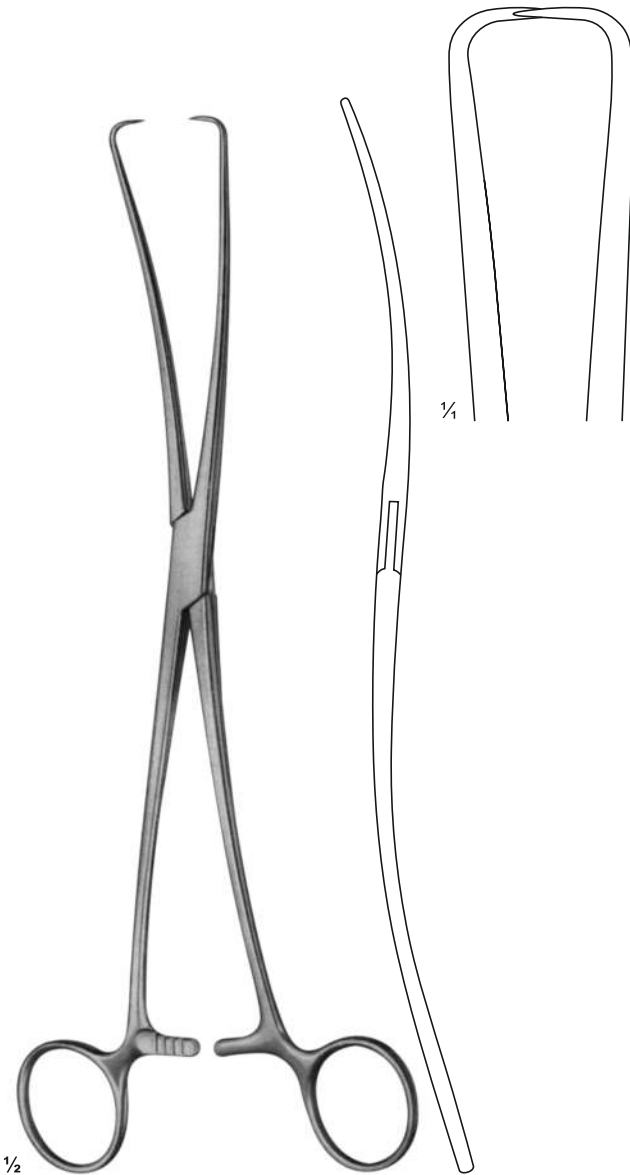

Duplay
HP-379-155
28 cm

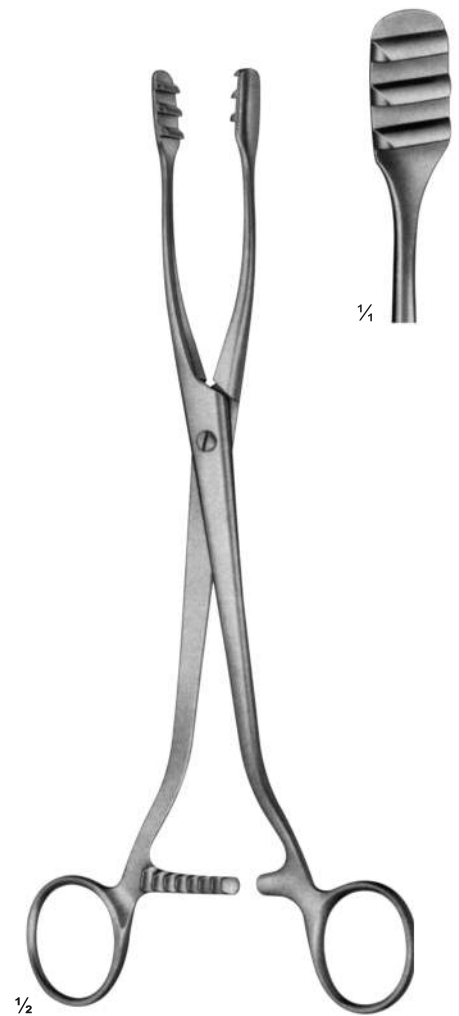

Collin
HP-379-156
25 cm

Uterine Tenaculum Forceps
Uterine Tenaculum Pinzette
Pinça de Tenaculum Uterina
Pinza tenaculum uterina



Skene
HP-380-157
24 cm



Teale
HP-380-158
23 cm



Kustner
HP-380-159
25 cm



Uterine Tenaculum Forceps
Uterine Tenaculum Pinzette
Pinça de Tenaculum Uterina
Pinza tenaculum uterina

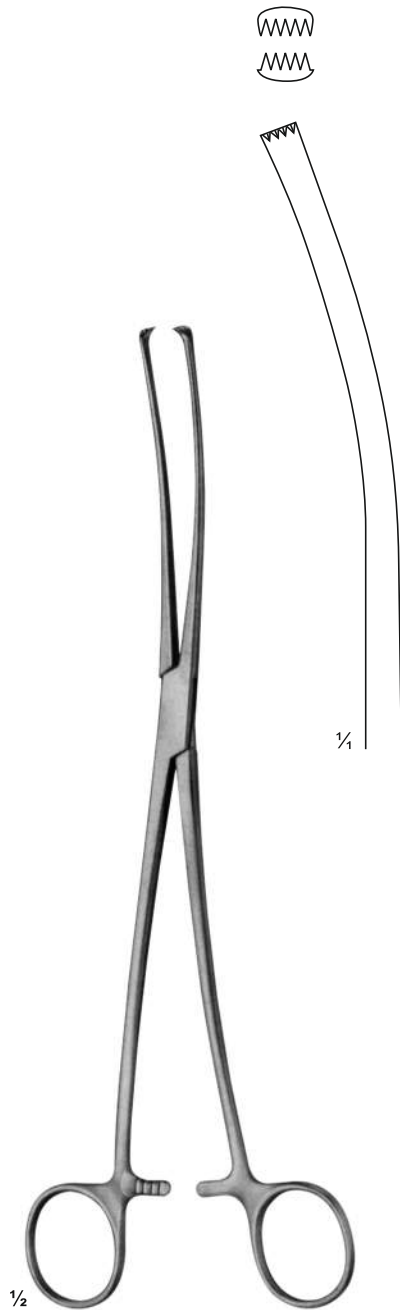

Lova
HP-381-160
26 cm

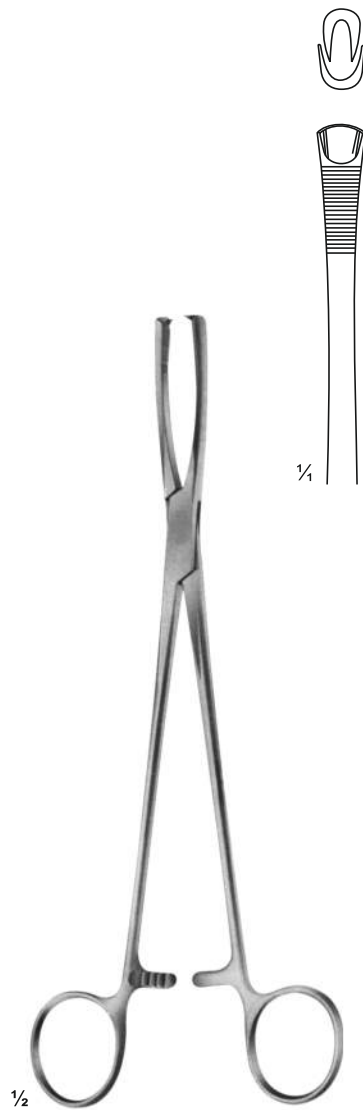

Jacobs
HP-381-161
21 cm



Museux
HP-381-162
20 cm



Uterine Tenaculum Forceps

Uterine Tenaculum Pinzette
Pinça de Tenaculum Uterina
Pinza tenaculum uterina



HP-382-163
6 mm

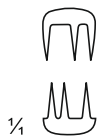

HP-382-166
9 mm



HP-382-169
6 mm



HP-382-164
8 mm



HP-382-167
11 mm



HP-382-170
8 mm



HP-382-165
10 mm



HP-382-168
13 mm



HP-382-171
10 mm

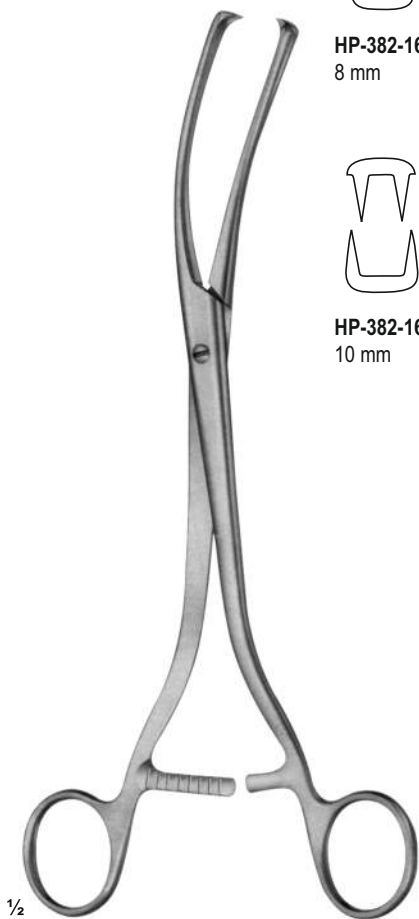

Museux
HP-382-163 - HP-382-165
24 cm
Curved sideways

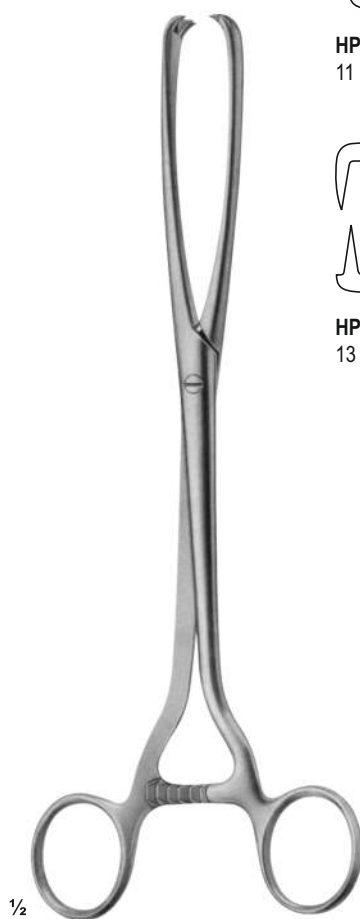

Museux
HP-382-166 - HP-382-168
24 cm
Curved sideways

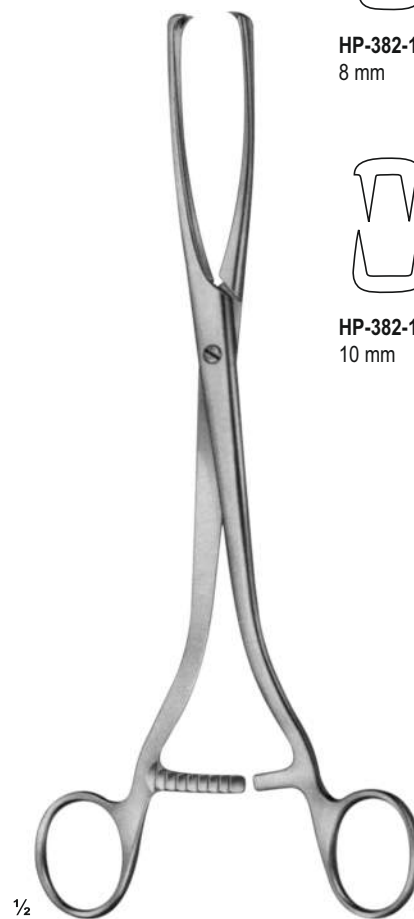

Museux
HP-382-169 - HP-382-171
24 cm



Uterine Tenaculum Forceps
Uterine Tenaculum Pinzette
Pinça de Tenaculum Uterina
Pinza tenaculum uterina

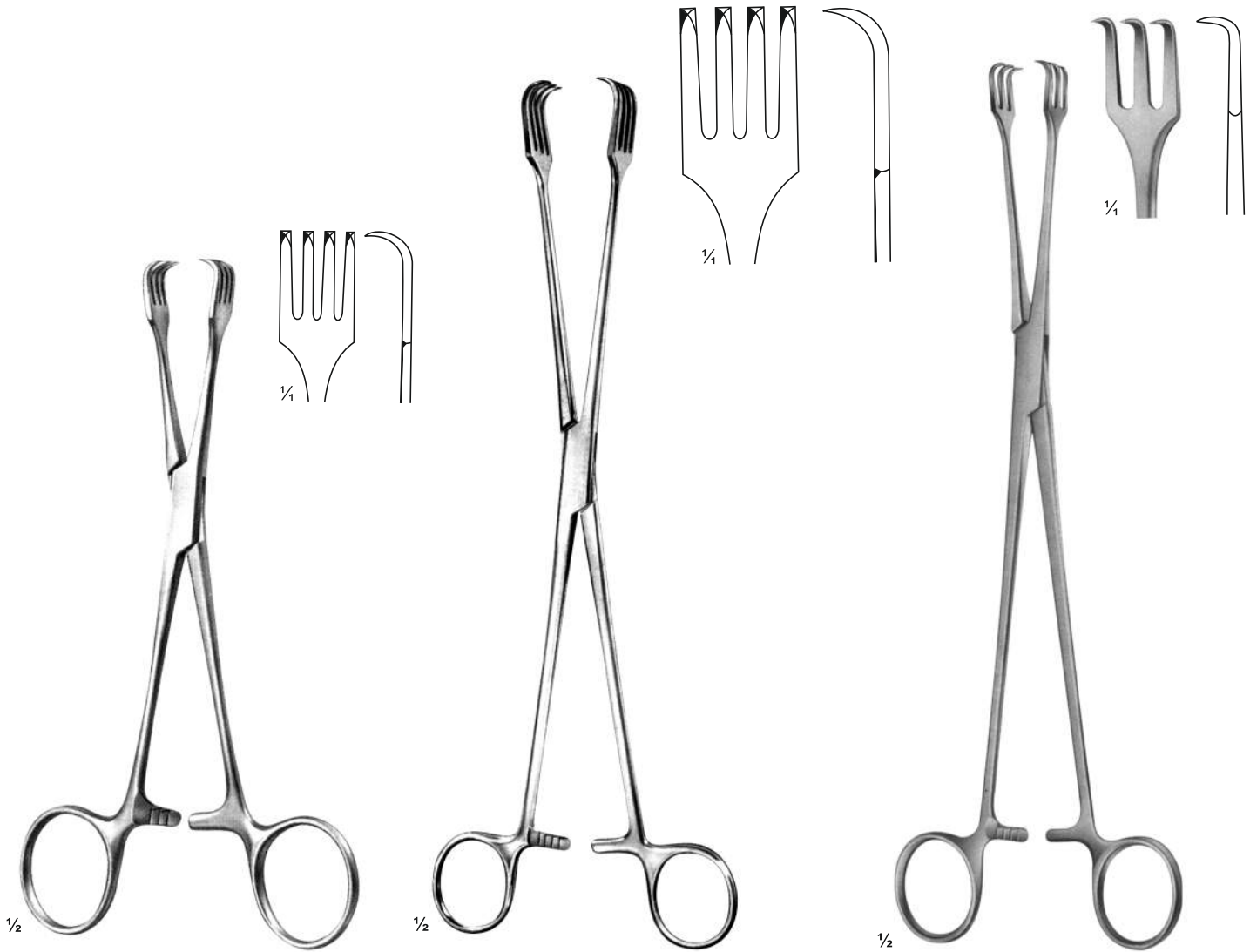

Barun
HP-383-172
21 cm



HP-383-173
26.5 cm



Schröder
HP-383-174
27 cm



Uterine Tenaculum Forceps
Uterine Tenaculum Pinzette
Pinça de Tenaculum Uterina
Pinza tenaculum uterina

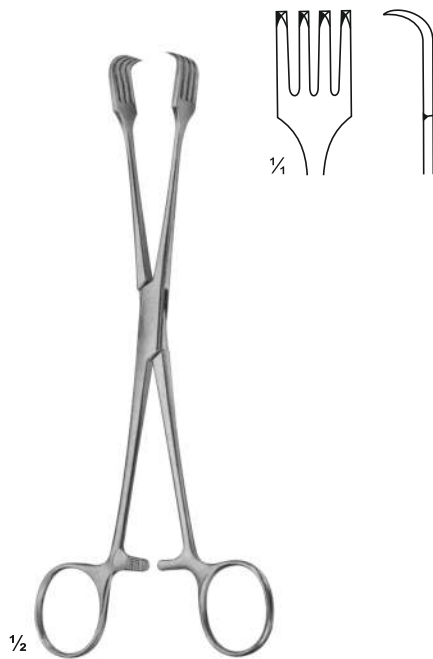

Czerny
HP-384-175
16 cm

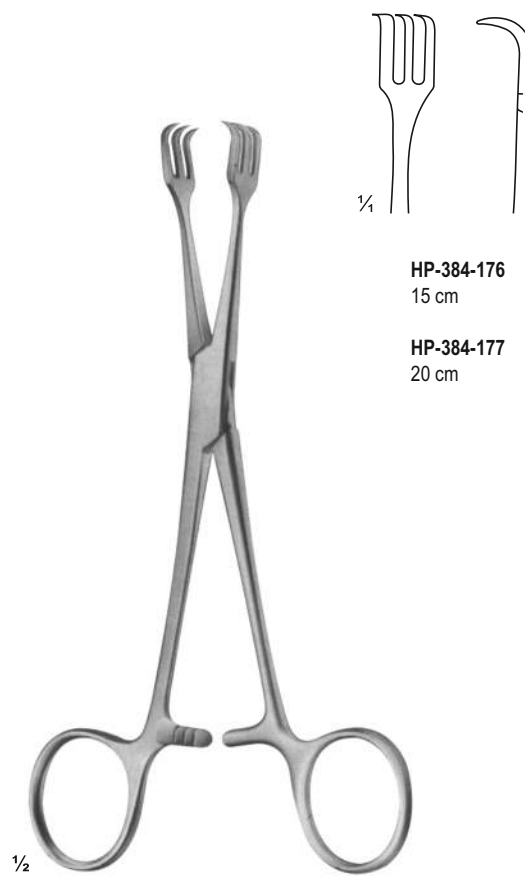

Lahey
HP-384-176 - HP-384-177
20 cm



Uterine Tenaculum Forceps
Uterine Tenaculum Pinzette
Pinça de Tenaculum Uterina
Pinza tenaculum uterina

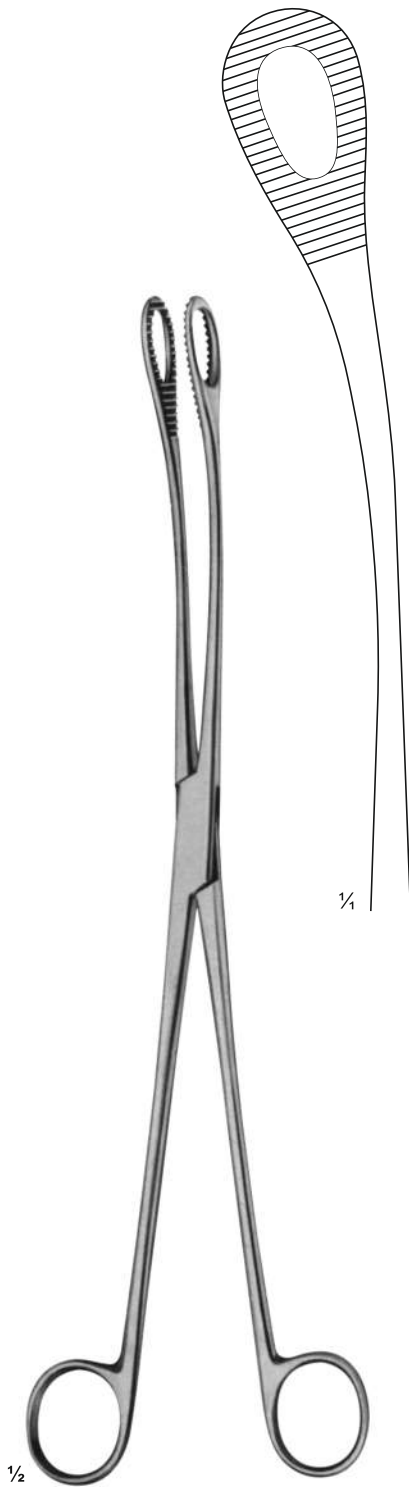

Kelly
HP-385-178
31.5 cm

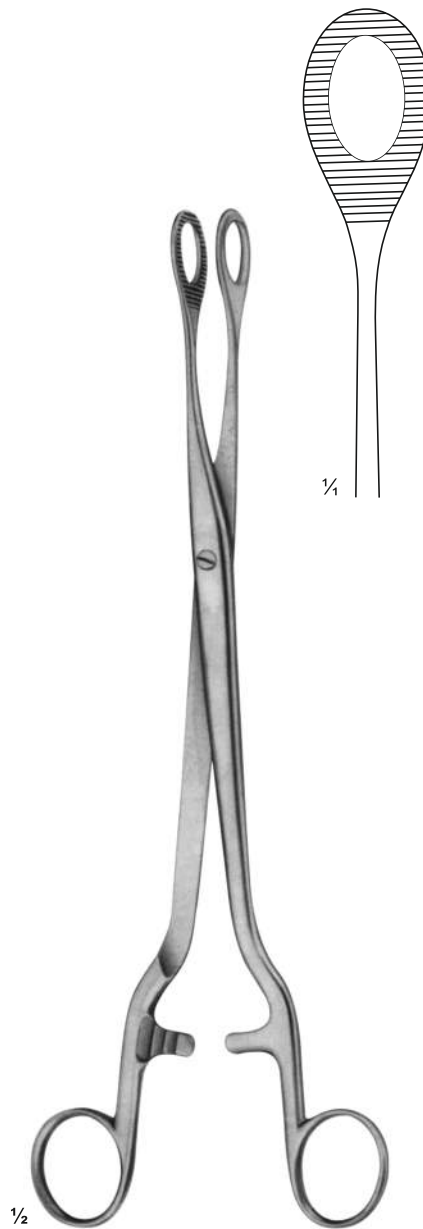

Noto
HP-385-179
27 cm

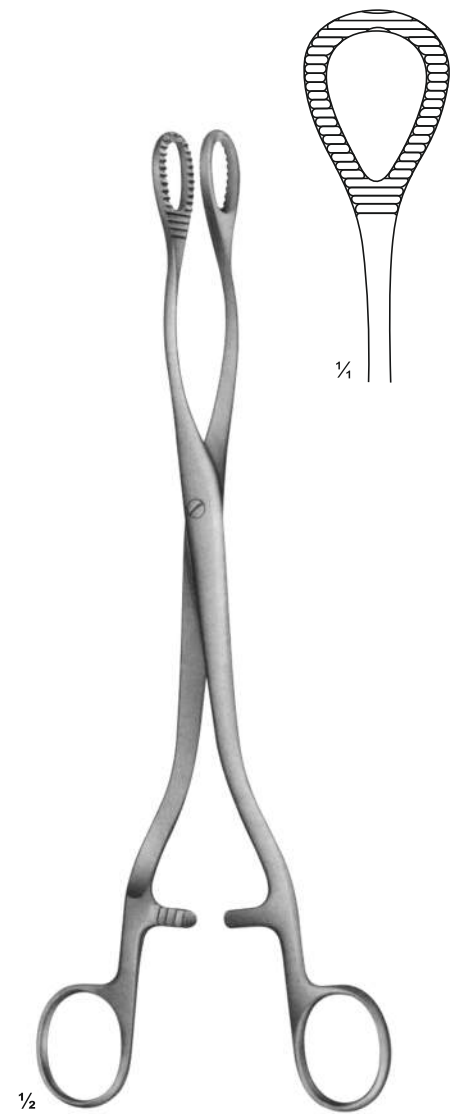

Heywood-Smith
HP-385-180
26 cm

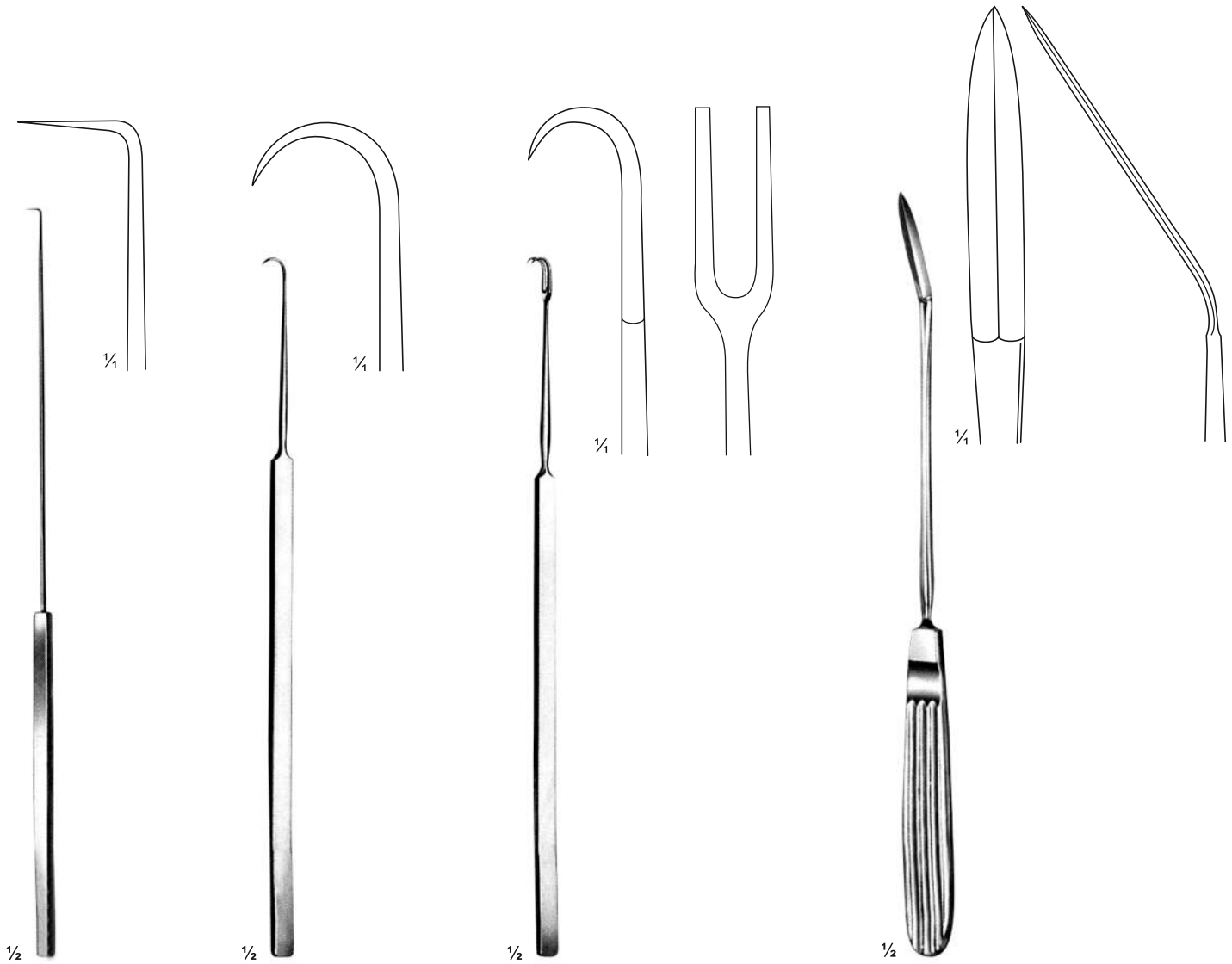

Fig. 3
 Emmett
HP-386-181
 23 cm

Simon
HP-386-182
 22 cm

Simon
HP-386-183
 22 cm

Ayre
HP-386-184
 23.5 cm
 Conization Knife
 cutting edge 6.3 mm wide

Uterine Scoops, Uterine Curettes

Uterine Scoops, Uterine Küretten
Colheres Uterinas, Curetas Uterinas
Uterine Scoops, Uterine Curettes



Fig. 1
HP-387-185
23 cm
10 x 7 mm



Fig. 1
HP-387-191
10 x 7 mm



Fig. 1
HP-387-197
10 x 7 mm



Fig. 2
HP-387-186
23.5 cm
12 x 8 mm



Fig. 2
HP-387-192
12 x 8 mm



Fig. 2
HP-387-198
12 x 8 mm

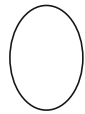

Fig. 3
HP-387-187
24 cm
13 x 10 mm



Fig. 3
HP-387-193
13 x 10 mm



Fig. 3
HP-387-199
13 x 10 mm

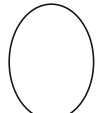

Fig. 4
HP-387-188
24 cm
16 x 12 mm

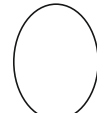

Fig. 4
HP-387-194
16 x 12 mm



Fig. 4
HP-387-200
16 x 12 mm

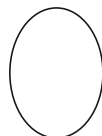

Fig. 5
HP-387-189
24 cm
18 x 13 mm



Fig. 5
HP-387-195
18 x 13 mm



Fig. 5
HP-387-201
18 x 13 mm

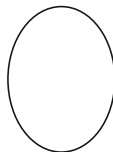
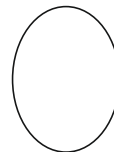

Fig. 6
HP-387-190
24 cm
20 x 15 mm



HP-387-196
20 x 15 mm



Fig. 6
HP-387-202
20 x 15 mm

1/2



1/2



1/2



1/2



1/4



Blunt
13 mm

Sharp
8 mm

Simon
HP-387-185 - HP-387-190
24 cm
Uterine scoop
sharp, rigid

Simon
HP-387-191 - HP-387-196
30 cm
Uterine scoop
sharp, rigid

Schröder
HP-387-197 - HP-387-202
Uterine scoop
sharp, rigid

Blake
HP-387-203
27.5 cm
Uterine curettes

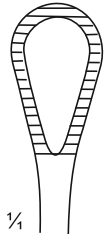

HP-388-204
 10 mm

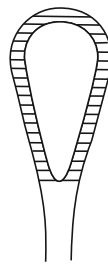

HP-388-205
 12 mm

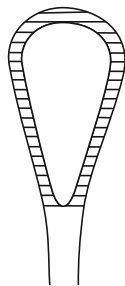

HP-388-206
 14 mm



1/2

Greene
 HP-388-204 - HP-388-206
 28 cm



1/2

Sims
 HP-388-207 - HP-388-213 (Sharp)
 HP-388-214 - HP-388-220 (Blunt)
 25.5 cm
 Flat handle



Fig. 1
 HP-388-207



Fig. 2
 HP-388-208



Fig. 3
 HP-388-209



Fig. 4
 HP-388-210

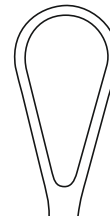

Fig. 5
 HP-388-211

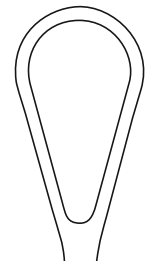

Fig. 6
 HP-388-212

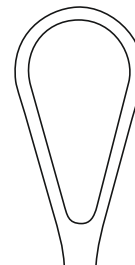

Fig. 7
 HP-388-213



Obstetrics

Geburtshilfe

Obstetrícia

Obstetricia

Page 390-394

Obstetrical Forceps
Geburtszange
Pinça Obstétrica
Pinzas obstétricas



HP-390-001
36.5 cm

HP-390-002
40.5 cm

Nögele
HP-390-001 - HP-390-002
36.5 cm



Wrigley
HP-390-003
28 cm



Simpson
HP-390-004
30.5 cm



Simpson
HP-390-005
36.5 cm

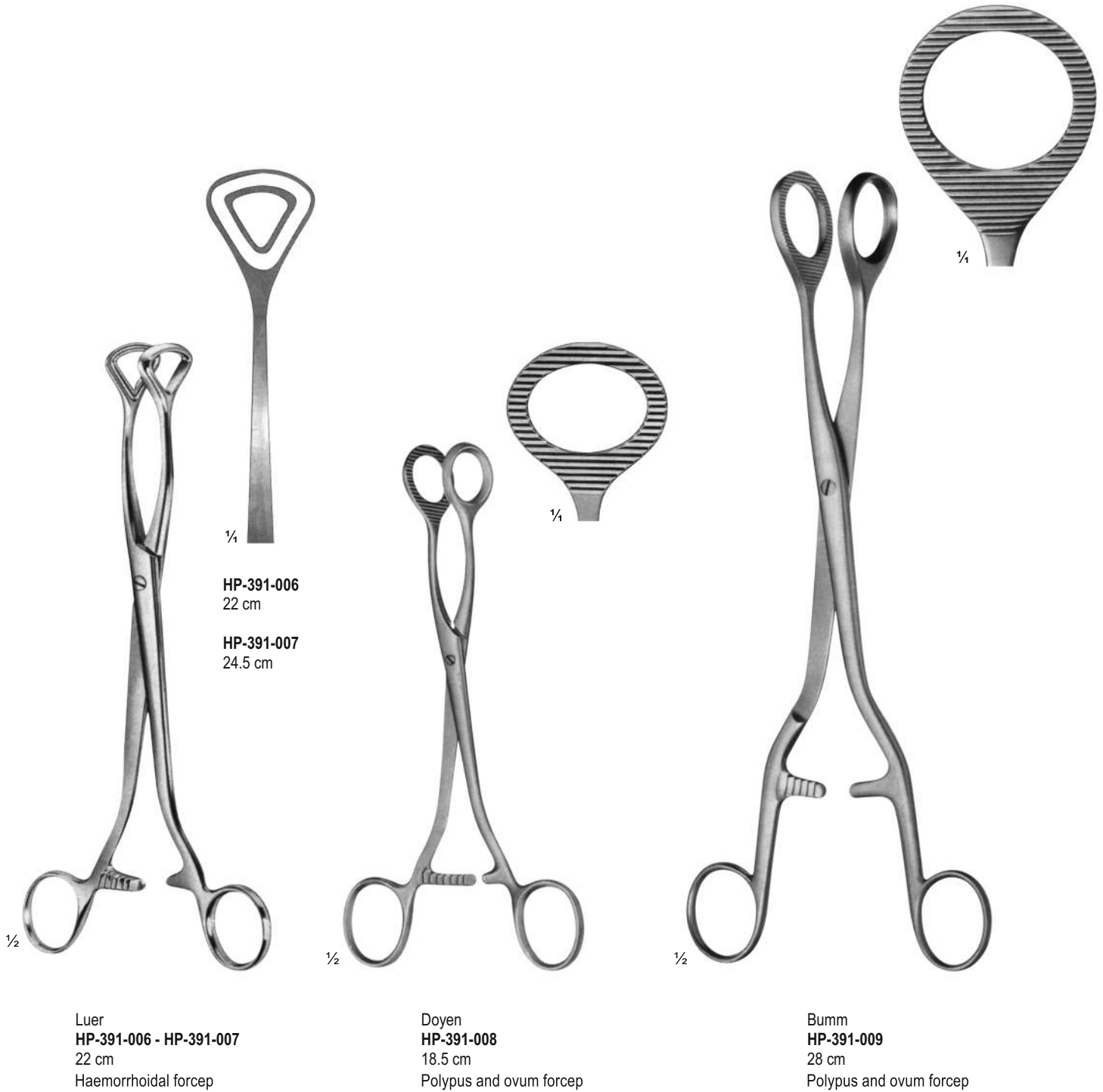

Placenta, Ovum Forceps

Plazenta, Ovum Pinzette
Placenta, Fórceps Ovum
Placenta, fórceps de óvulo

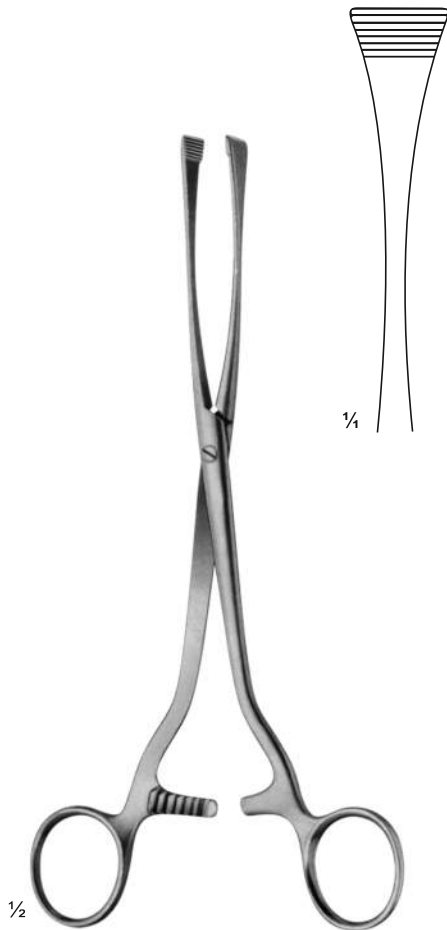

Green-Armytage
HP-392-010
21 cm
Uterine clamp

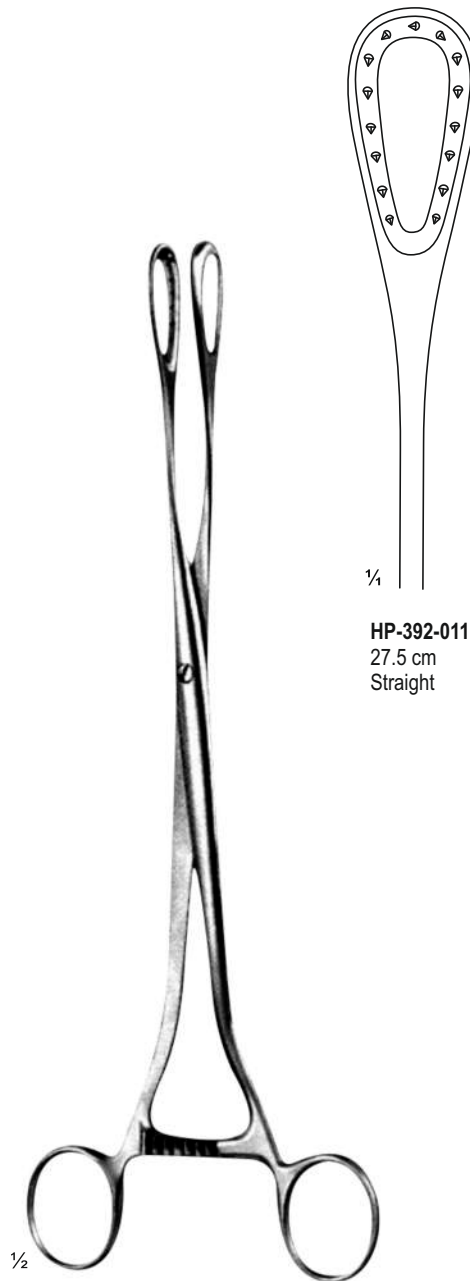

HP-392-011
27.5 cm
Straight

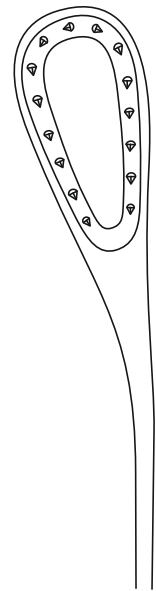

HP-392-012
27 cm
Curved



Willett
HP-393-013
18.5 cm
Scalp flap forceps

Gauss
HP-393-014
26 cm
Scalp flap forceps

Sellheim
HP-393-015
32 cm
Obstetrical lever



Calipers

Bremssättel

Pinças

Calibrador

Page 395-397

Trowel Knives, Calipers
Kelle Messer, Bremssättel
Facas de colher de pedreiro, pinças
Paleta cuchillos, pinzas

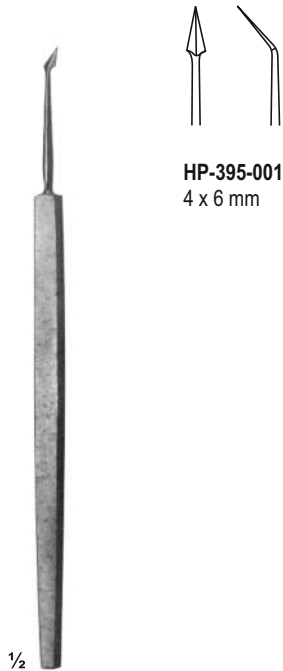

HP-395-001
4 x 6 mm

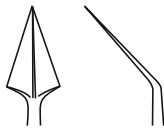

HP-395-002
7 x 11 mm

1/2

HP-395-001 - HP-395-002
16.5 cm
Trowel knife



1/2

Castroviejo
HP-395-003
8 cm
Effective range
0-15 mm



1/2

Castroviejo
HP-395-004
8 cm
Effective range
0-20 mm



1/2

Castroviejo
HP-395-005
8 cm
Effective range
0-20 mm



Castroviejo-Epker
HP-396-006
9 cm
Effective range
0-40 mm



Castroviejo-Epker
HP-396-007
18 cm
Effective range
0-40 mm



Otology

Otologie

Otologia

Otología

Page 398-412

Micro Ear Forceps
Mikro-Ohrzange
Fórceps Micro Orelha
Pinzas micro para el oído

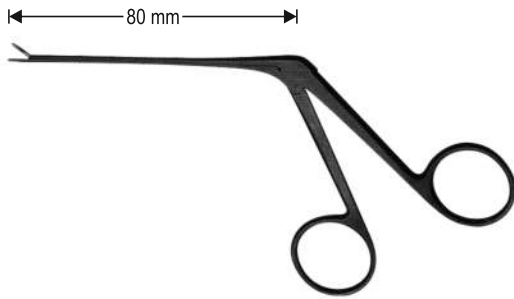

HP-398-001 - HP-398-005

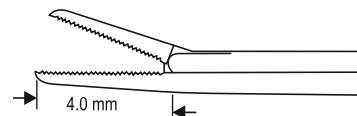
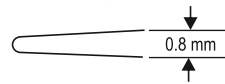
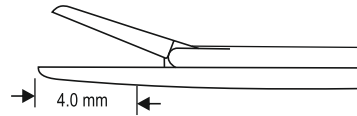

HP-398-001
4.0 x 0.8 mm
Smooth, straight



HP-398-002
4.0 x 0.8 mm
Serrated, straight



HP-398-003
4.0 x 0.8 mm
Sent upwards, serrated

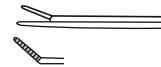

HP-398-004
4.0 x 0.8 mm
Right, serrated

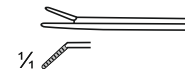

HP-398-005
4.0 x 0.8 mm
Left, serrated

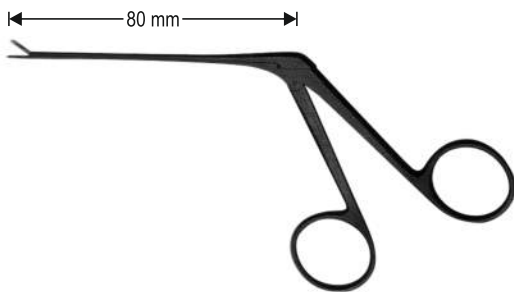

Mini-McGee
HP-398-006 - HP-398-007

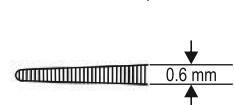
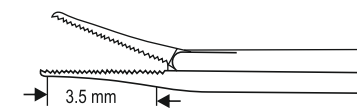
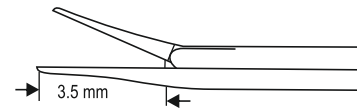

HP-398-006
3.5 x 0.6 mm
Smooth, straight

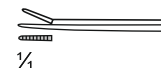

HP-398-007
3.5 x 0.6 mm
Serrated, straight

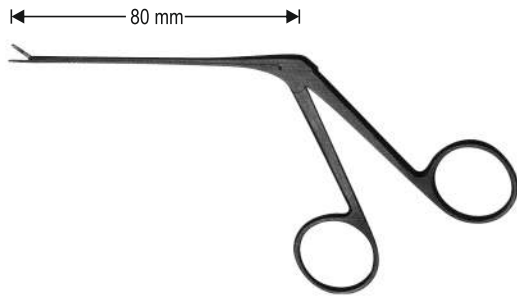

HP-399-008

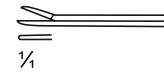
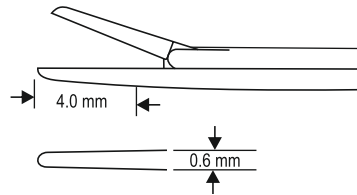

Smooth, straight

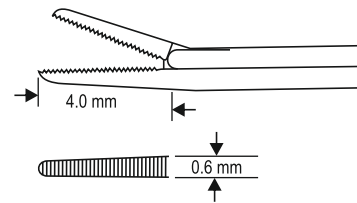

HP-399-009
 4.0 x 0.6 mm
 Serrated, straight

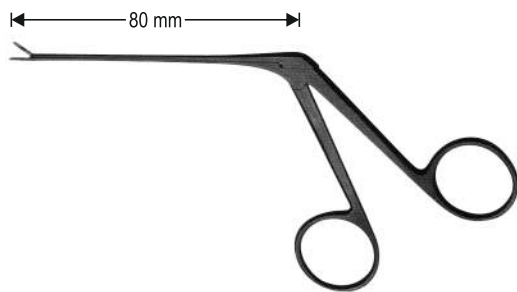

HP-399-009 - HP-399-012

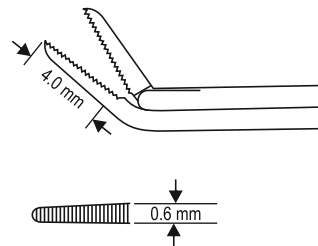

HP-399-010
 4.0 x 0.6 mm
 Bent upwards, serrated



HP-399-011
 4.0 x 0.6 mm
 Bight, serrated

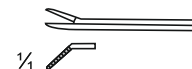

HP-399-012
 4.0 x 0.6 mm
 Left, serrated

Micro Ear Forceps
Mikro-Ohrzange
Fórceps Micro Orelha
Pinzas micro para el oído

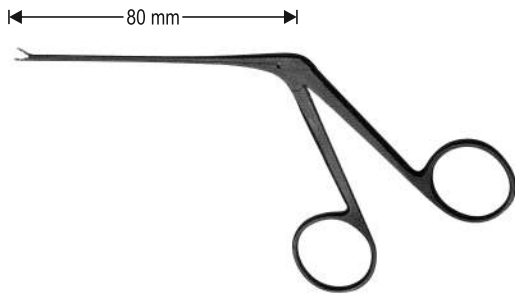

HP-400-013 - HP-400-016

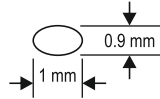
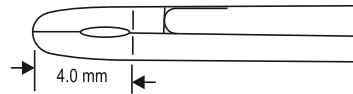

Cup 1 x 0.9 mm

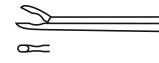

HP-400-013
4.0 mm
Straight

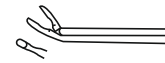

HP-400-014
4.0 mm
Bent upward

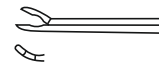

HP-400-015
4.0 mm
Right

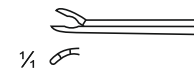

HP-400-016
4.0 mm
Left

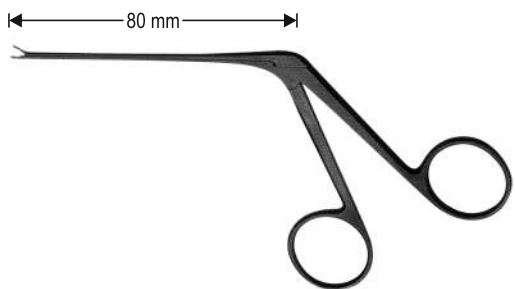

Mini-McGee
HP-400-017 - HP-400-020

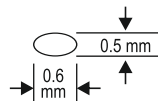
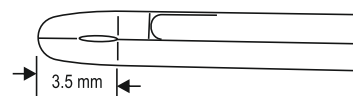

Cup 0.6 x 0.5 mm



HP-400-017
3.5 mm
Straight

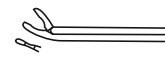

HP-400-018
3.5 mm
Bent Upward



HP-400-019
3.5 mm
Right

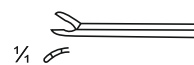

HP-400-020
3.5 mm
Left



¼



Fig. 1
HP-401-121
5.5 X 6.5 mm



Fig. 2
HP-401-122
6.5 X 7.5 mm



Fig. 3
HP-401-123
7.5 X 8.5 mm



Fig. 4
HP-401-124
8.5 X 9.5 mm



Fig. 5
HP-401-125
9.5 X 10.5 mm

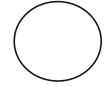

Fig. 6
HP-401-126
10.5 X 11.5 mm

Zöllner
HP-401-121 - HP-401-127
Oval, black

Fig. 1-6
HP-401-127
Ear specula set
for adults



¼



Fig. 1
HP-401-128
Ø 2 mm



Fig. 2
HP-401-129
Ø 3 mm



Fig. 3
HP-401-130
Ø 4 mm



Fig. 4
HP-401-131
Ø 5 mm

Poltitzer
HP-401-128 - HP-401-132

Fig. 1-4
HP-401-132
Set of 4
for adults



¼



Fig. 0
HP-401-133
Ø 3.0 mm



Fig. 1
HP-401-134
Ø 4.5 mm



Fig. 2
HP-401-135
Ø 5.5 mm

Boucheron
HP-401-133 - HP-401-136

Fig. 0-2
HP-401-136
Set of 3
for children



¼



Fig. 1
HP-401-137
Ø 4.5 mm



Fig. 2
HP-401-138
Ø 5.5 mm



Fig. 3
HP-401-139
Ø 6.5 mm



Fig. 4
HP-401-140
Ø 7.5 mm

Hartmann
HP-401-137 - HP-401-141

Fig. 1-4
HP-401-141
Set of 4
for adults

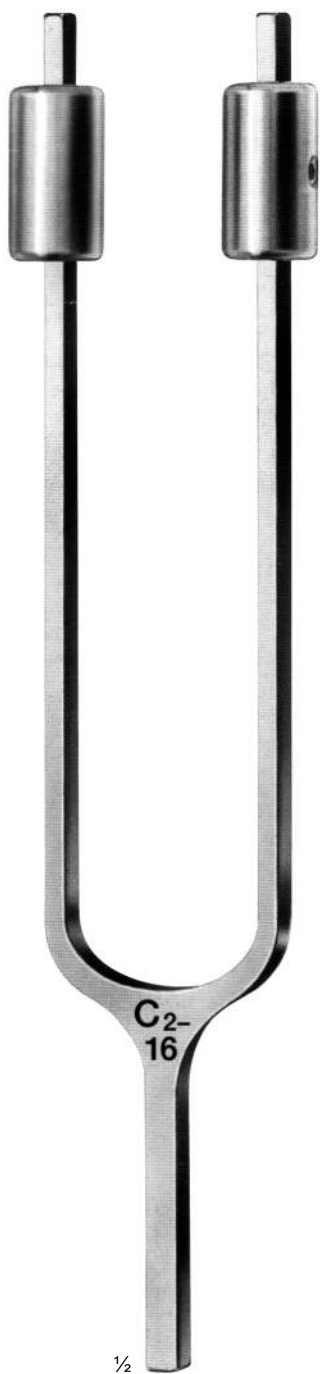

French
HP-402-142
C.16

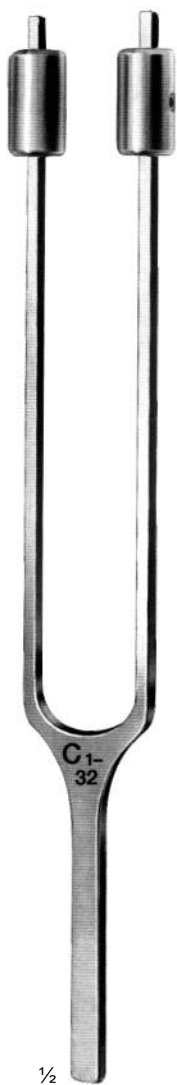

French
HP-402-143
C.32

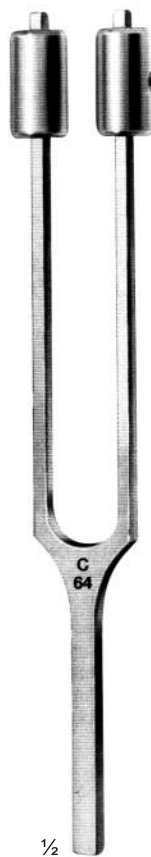

Hartmann
HP-402-144
C 64

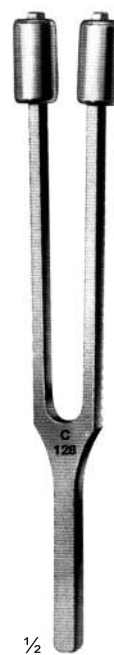

Hartmann
HP-402-145
C 128



Hartmann
HP-402-146
C¹ 256



Hartmann
HP-403-147
C 128



Hartmann
HP-403-148
C¹ 256



Hartmann
HP-403-149
C² 512



Hartmann
HP-403-150
C³ 1024



Hartmann
HP-403-151
C⁴ 2048



Hartmann
HP-403-152
C⁵ 4096



1/2

Lucae
HP-404-153
C 128

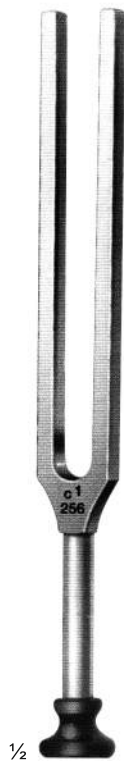

1/2

Lucae
HP-404-154
C¹ 256



1/2

Lucae
HP-404-155
C² 512



1/2

Lucae
HP-404-156
C³ 1024



1/2

Lucae
HP-404-157
C⁴ 2048



1/2

Lucae
HP-404-158
C⁵ 4096

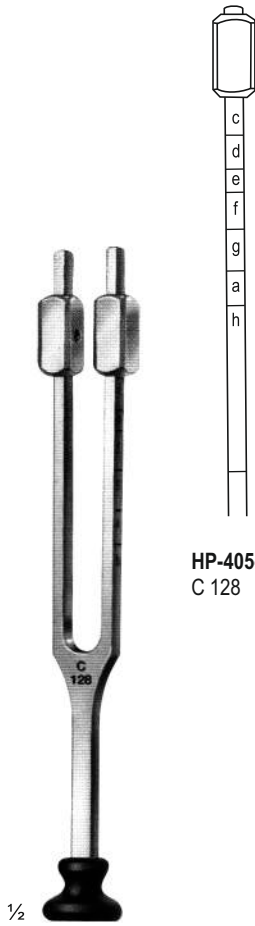

HP-405-159
C 128

HP-405-160
Socket, only

1/2

Lucae
HP-405-159 - HP-405-160
C 128
Moveable up to h

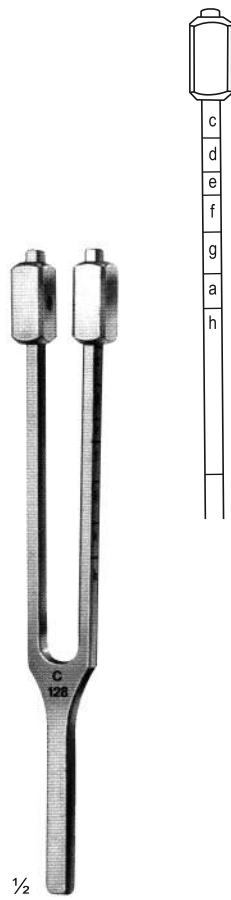

1/2

Hartmann
HP-405-161
C 128
Moveable up to h

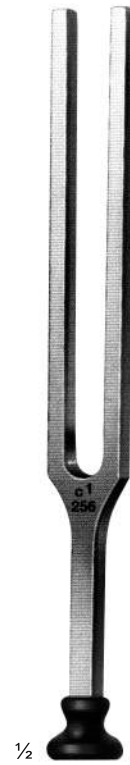

1/2

HP-405-163
Socket, only

Hartmann
HP-405-162
C' 256

HP-405-162 - HP-405-163

HP-406-165
Damper
white scale

HP-406-166
Damper
black scale



HP-406-164



HP-406-164

HP-406-167
knurled screw

HP-406-168
Weights, C 64



HP-406-164



HP-406-164



Rydel-Seiffert
HP-406-164 - HP-406-168
C 64 / C 128
Also for neurology



Neuro
HP-406-169
With hammer, pinwheel,
brush and needle

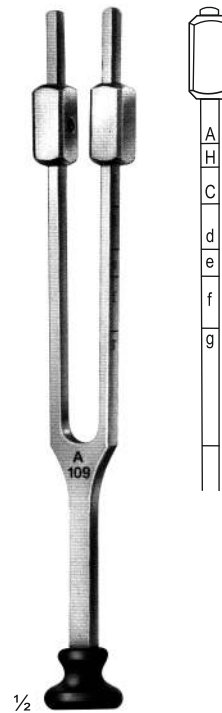

König
HP-406-170 - HP-406-172
A 109
Moveable up to h

HP-406-171
Bakelit base



HP-406-172

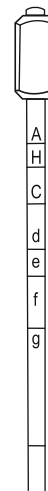

HP-406-172
a' 440



Fig. 1
 HP-407-173

Fig. 2
 HP-407-174

Fig. 3
 HP-407-175

Hartmann
 HP-407-173 - HP-407-175
 15 cm
 Ear catheters

1/2



Krause
 HP-407-176 - HP-407-177
 HP-407-176 18.5 cm
 HP-407-177 26 cm
 Open tip

1/2



HP-407-180
 Polypus snares

→ HP-407-178
 HP-407-179

Krause-Voss
 HP-407-178 - HP-407-180
 HP-407-178 18.5 cm
 HP-407-179 26 cm
 Closed tip

1/2



HP-407-181 - HP-407-182
 HP-407-181 Ø 0.3 cm
 HP-407-182 Ø 0.4 cm
 Snare wire, coil of 10 m

Ear Forceps, Ear Polypus Forceps

Ohrzange, Ohrpolypenzange
Fórceps de Ouvido, Fórceps de Ortopédico
Pinzas para oídos, pinzas para polypus

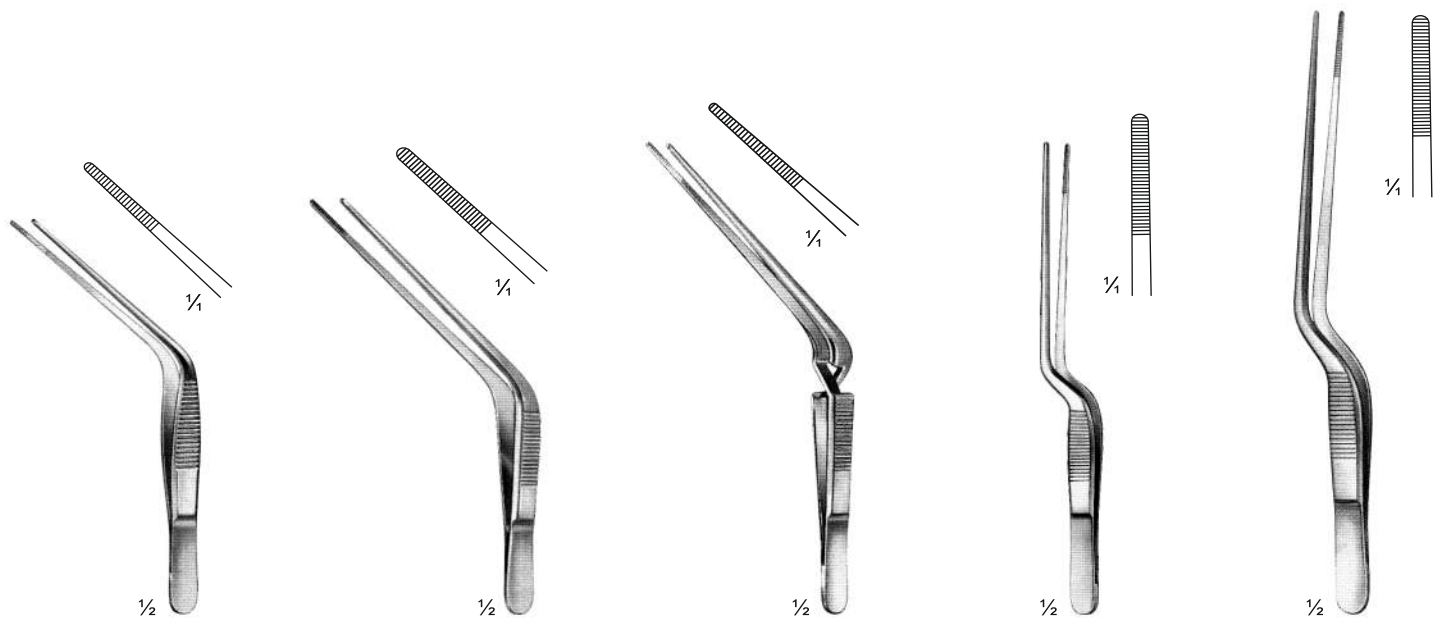

Tröltzsch (Wilde)
HP-408-183
10.5 cm

Tröltzsch (Wilde)
HP-408-184
11 cm

Tröltzsch (Wilde)
HP-408-185
12.5 cm

Grünwald
HP-408-186
12.5 cm

Jansen
HP-408-187 - HP-408-188
HP-408-187 16 cm
HP-408-188 21.5 cm

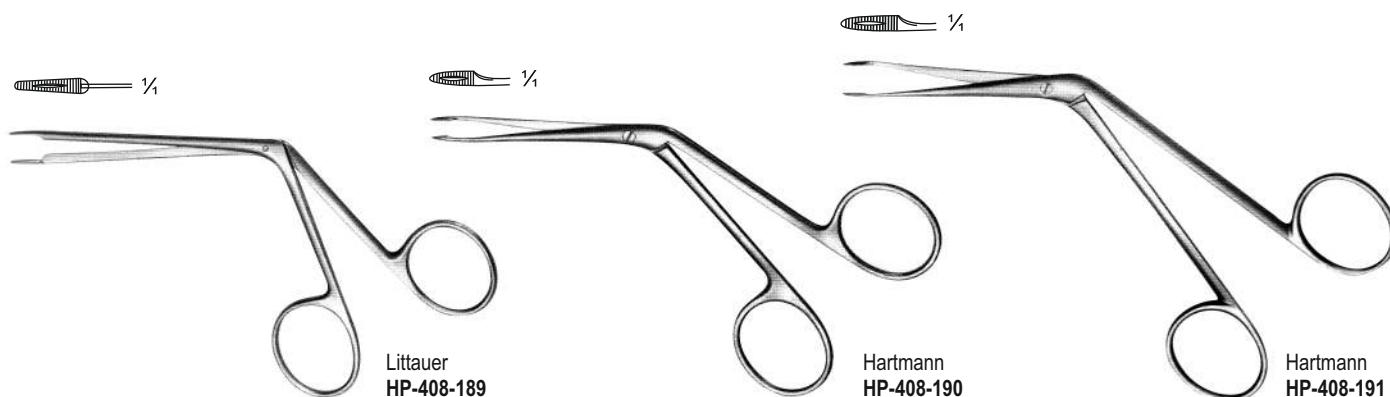

Littauer
HP-408-189
Ear polypus forceps
shaft length
75 mm

Hartmann
HP-408-190
Ear polypus forceps
delicate pattern
shaft length
65 mm

Hartmann
HP-408-191
Ear polypus forceps
regular model
shaft length
65 mm



Buck
HP-408-192
11.5 cm
Foreign body lever

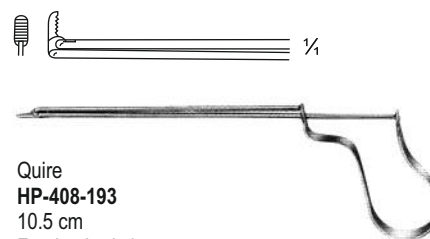

Quire
HP-408-193
10.5 cm
Foreign body lever



Hartmann-Wullstein
HP-409-194
Shaft length
85 mm

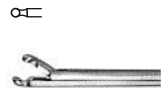

Hartmann-Wullstein
HP-409-195
Ø 1.0 mm
Shaft length
85 mm

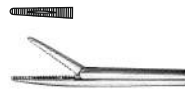

Hartmann
HP-409-196
Shaft length
85 mm

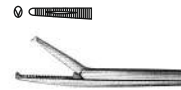

Hartmann
HP-409-198



Shaft length
85 mm



HP-409-194 - HP-409-204

HP-409-197
Shaft length
140

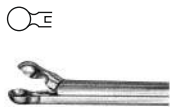

Hartmann-Herzfeil
HP-409-199
2.0 mm
Shaft length
85 mm

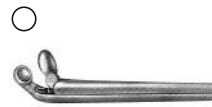

Hartmann
HP-409-202
3.0 mm
Shaft length
85 mm

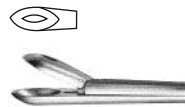

Strümpel
HP-409-203
Shaft length
85 mm

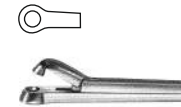

Hartmann-Hoffmar
HP-409-204
2.0 mm
Through-cutting
85 mm

○
HP-409-200
Ø 2.5 mm
Shaft length
85 mm

○
HP-409-201
Ø 3.0 mm
Shaft length
85 mm



McGee
HP-409-205
Wire bending forceps
3.5 mm
length 0.8 mm

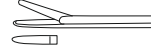

Fuller
HP-409-206
Introducing forceps
for teflon prosthesis
80 mm

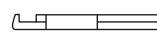

HP-409-207
Up - cutting

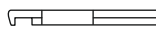

HP-409-208
Down - cutting

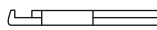

HP-409-209
Right - cutting

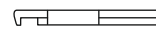

HP-409-210
Left - cutting

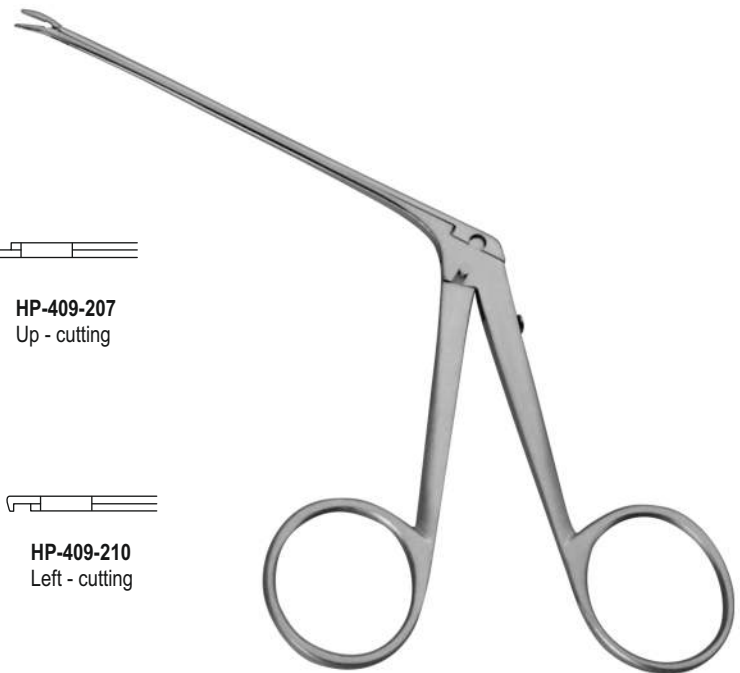

Dieter
HP-409-749-205 - HP-409-749-210
Malleus nipper
length 80 mm

Micro Ear Forceps, Micro Ear Scissors

Mikro-Ohrzange, Mikro-Ohrscherer
Micro Ear Forceps, Micro Ear Scissors
Micro Ear Forceps, Micro Ear Scissors



HP-410-211
Straight, oval
length 75 mm



HP-410-212
Curved upwards, oval
length 75 mm



HP-410-213
Curved to left, oval
length 75 mm



HP-410-214
Curved to right, oval
length 75 mm



HP-410-215
Curved downwards, oval
length 75 mm



HP-410-211 - HP-410-215



HP-410-216
Straight,
sharp/sharp
length 75 mm



HP-410-217
Curved upwards,
blunt/blunt
length 75 mm



HP-410-218
Curved to right,
sharp/sharp
length 75 mm



HP-410-219
Curved to left,
sharp/sharp
length 75 mm



HP-410-220
Straight,
sharp/blunt
length 75 mm

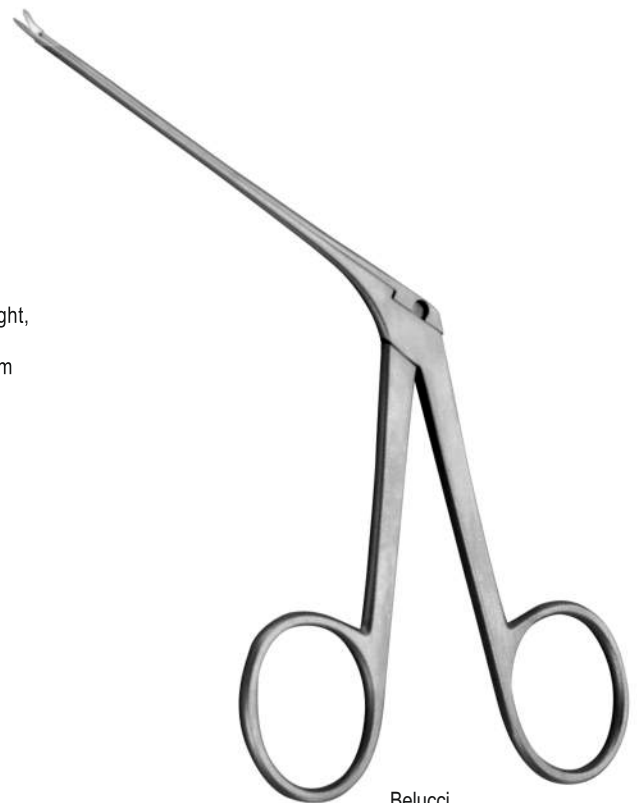

Belucci
HP-410-216 - HP-410-220

¼ C



Citelli
HP-411-221
2 mm
Shaft length
75 mm

¼ C



Citelli
HP-411-222
3 mm
Shaft length
75 mm

¼ C

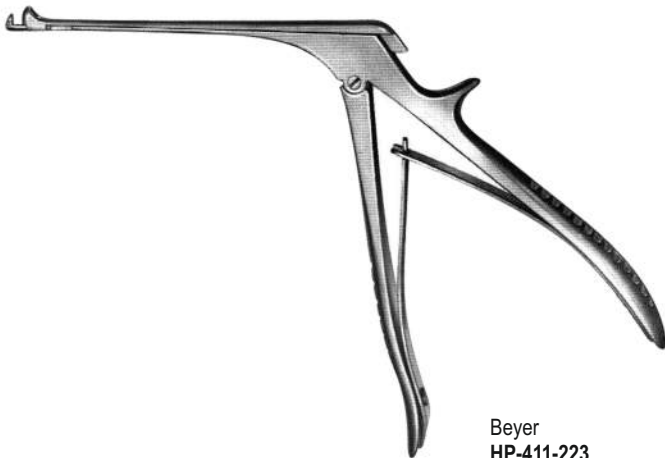

Beyer
HP-411-223
2 mm
Shaft length
95 mm

¼ C

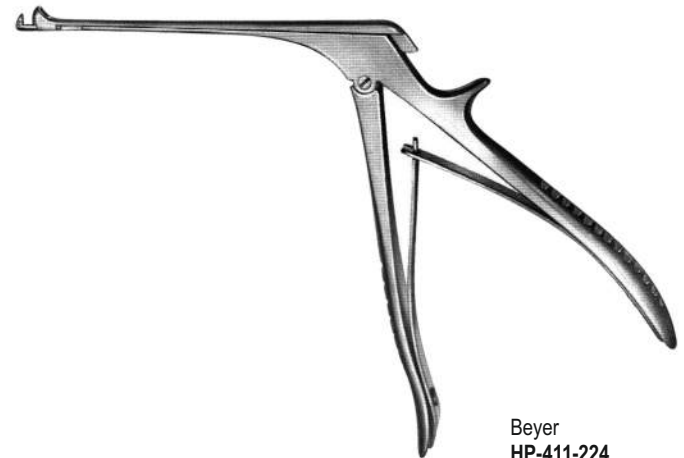

Beyer
HP-411-224
1 mm
Shaft length
95 mm

Ear Scoop, Ear Syringes
Ear Scoop, Ohrspritzen
Colher de ouvido, seringas de ouvido
Ear Scoop, Ear Syringes



Fig. 1
HP-412-225



HP-412-233
Irrigation adapter



Fig. 2
HP-412-226



HP-412-234
Irrigation adapter



Fig. 3
HP-412-227



HP-412-230
50 ml
Complete with protection disc and 2 tips

HP-412-232
Ear syringe



Fig. 4
HP-412-228



Fig. 5
HP-412-229



Lempert
HP-412-225 - HP-412-229
21.5 cm
Ear scoop sharp

HP-412-231
100 ml
Complete with protection disc and 2 tips

HP-412-230 - HP-412-233



Rhinology

Rhinologie

Rinologia

Rinología

Page 413-431

Nasal Tampon Forceps
Nasen-Tampon-Pinzette
Pinça de Tampon Nasal
Pinzas nasales para tampones



Trölsch
HP-413-001
14.5 cm

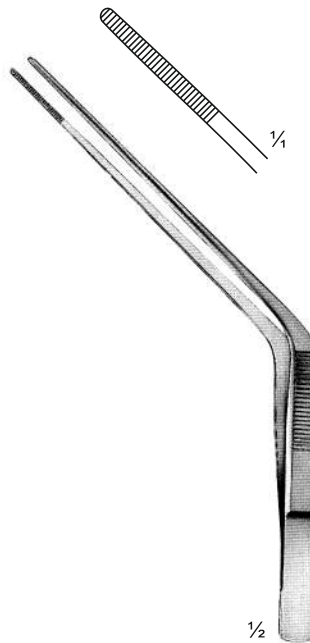

Trölsch
HP-413-002
15.5 cm

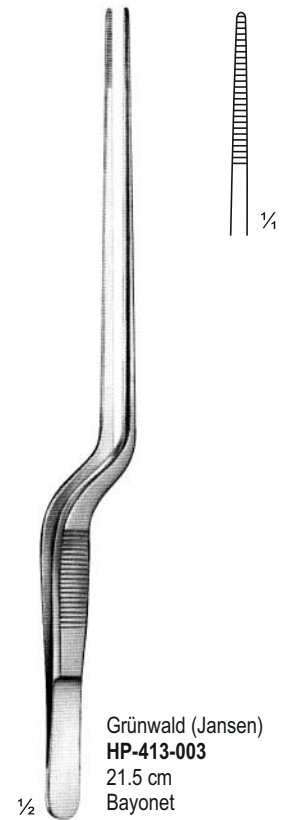

Grünwald (Jansen)
HP-413-003
21.5 cm
Bayonet



Westmacott
HP-413-004
20 cm



Lubet-Barbon
HP-413-005
18.5 cm



Hartmann
HP-413-006
18.5 cm
Nasal polypus forceps



Knight
HP-414-007
17 cm

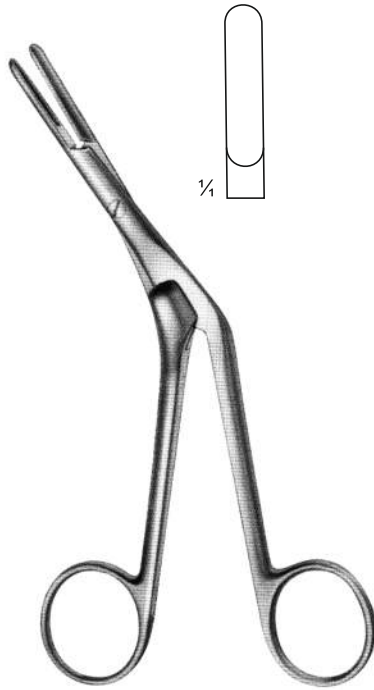

Graig
HP-414-008
17 cm



HP-414-009
Left curved



HP-414-010
Right curved

HP-414-009 - HP-414-010
15.5 cm



Fig. 1
HP-414-011

Fig. 2
HP-414-012

Luc
HP-414-011 - HP-414-012
20 cm
Ethmoid bone forceps



Fig. 1
HP-414-013



Fig. 2
HP-414-014



Fig. 3
HP-414-015



Fig. 4
HP-414-016

Brünings
HP-414-013 - HP-414-016
16.5 cm

Sphenoid Bone Punches
Sphenoid Knochen Stanzen
Socos de osso esfenoidal
Punzones de hueso esfenoides

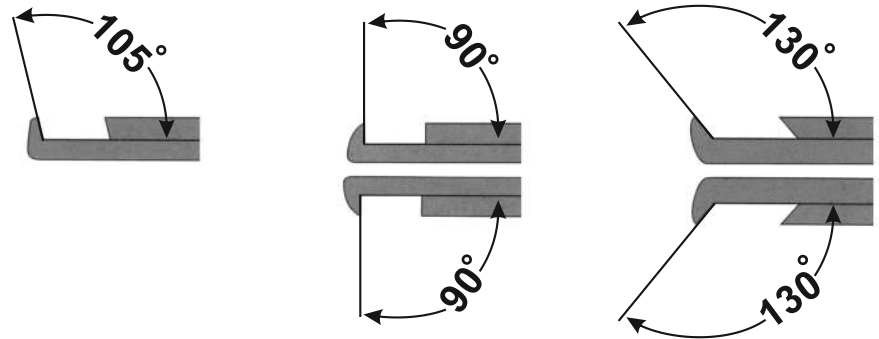

90° upwards cutting

65 mm

HP-415-017
2 mm

HP-415-018
3.5 mm



Citelli
HP-415-017 - HP-415-018

90° upwards cutting

95 mm



Citelli-Beyer
HP-415-019
1.8 mm



HP-416-020
 Up cutting
 4.0 x 4.0 mm
 Shaft length
 140 mm

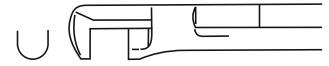

HP-416-021
 Down cutting
 4.0 x 4.0 mm
 Shaft length
 145 mm



HP-416-022
 Up cutting
 3.5 x 3.5 mm
 Shaft length
 140 mm



HP-416-023
 Down cutting
 3.5 x 3.5 mm
 Shaft length
 145 mm

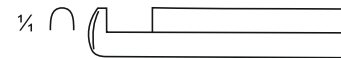
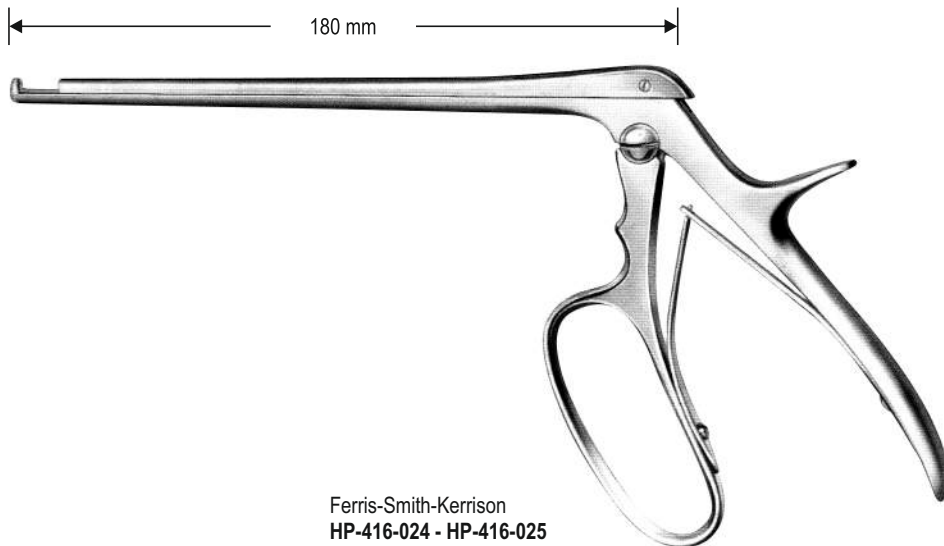

HP-416-024
 Up cutting
 3.0 x 3.0 mm

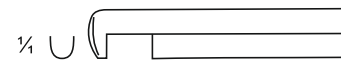

HP-416-025
 Down cutting
 3.0 x 3.0 mm

Sphenoid Bone Punches

Sphenoid Knochen Stanzen

Socos de osso esfenoidal

Punzones de hueso esfenoides

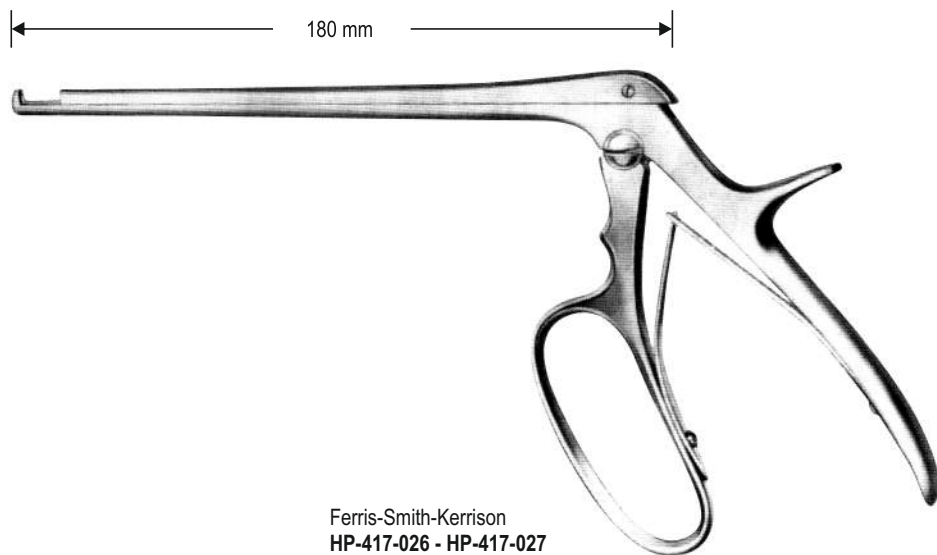

HP-417-026
Up cutting
5.0 x 5.0 mm

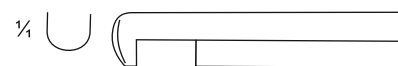

HP-417-027
Down cutting
5.0 x 5.0 mm

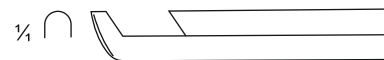
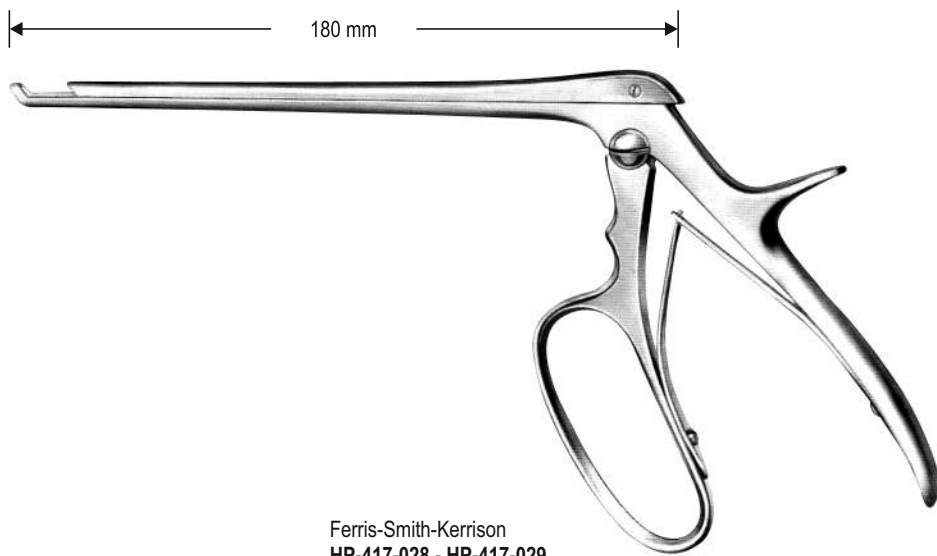

HP-417-028
Obliquely forward cutting
3 mm

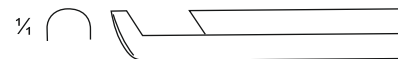

HP-417-029
Obliquely forward cutting
5 mm

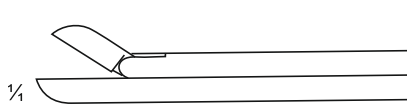
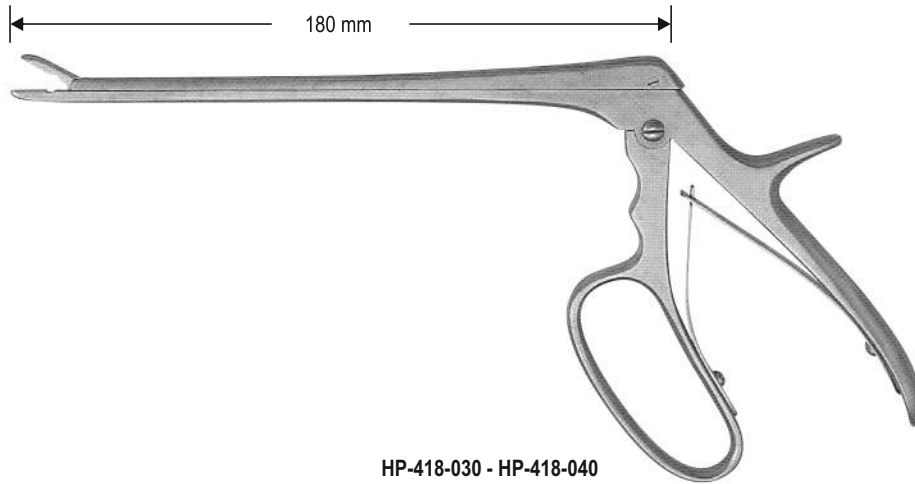

HP-418-030
10 x 2 mm



HP-418-031
10 x 3 mm



HP-418-032
10 x 4 mm



HP-418-033
10 x 5 mm



HP-418-034
10 x 6 mm

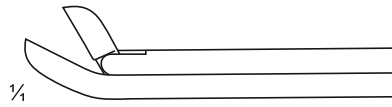

HP-418-035
10 x 2 mm



HP-418-036
10 x 3 mm



HP-418-037
10 x 4 mm

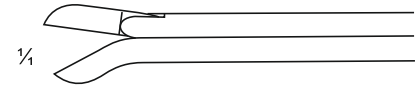

HP-418-038
10 x 2 mm



HP-418-039
10 x 3 mm



HP-418-040
10 x 4 mm

Antrum Punches

Antrum Schläge
Antrum Socos
Antrum Punches

90 mm



HP-419-041
3 x 3 mm



HP-419-042
4 x 4 mm



HP-419-043
5 x 5 mm



HP-419-044
6 x 6 mm

Kerrison
HP-419-041 - HP-419-044
20 cm
Shaft length
90 mm
Up cutting

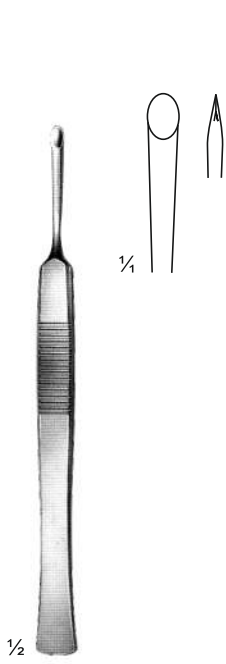

Cottle
HP-420-045
 14 cm
 Rhinoplastic knife

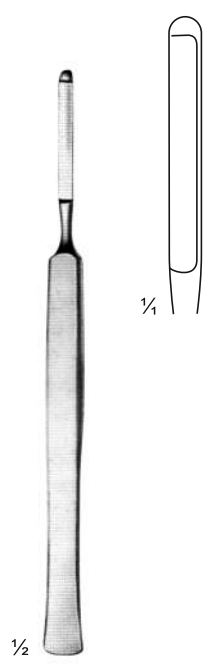

Joseph
HP-420-046
 15.5 cm
 Rhinoplastic knife

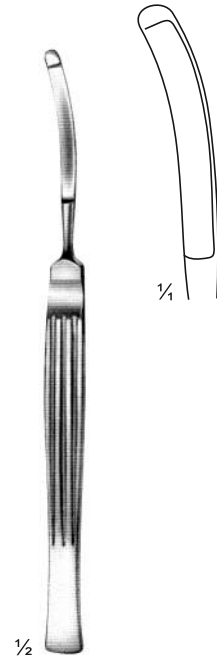

Converse
HP-420-047
 16 cm
 Rhinoplastic knife

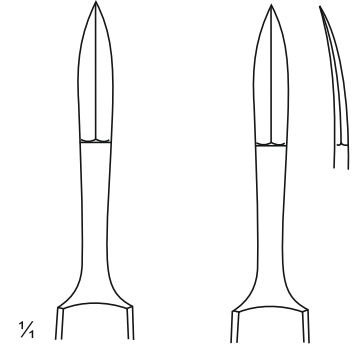
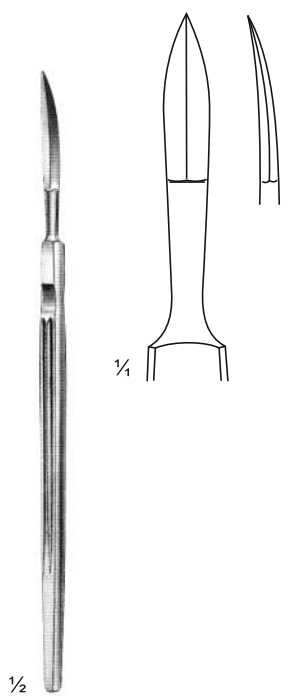

Fig. 1
HP-420-048

Fig. 2
HP-420-049



Joseph
HP-420-048 - HP-420-049
 15.5 cm
 Rhinoplastic knife



Fomon
HP-420-050
 16.5 cm
 Rhinoplastic knife

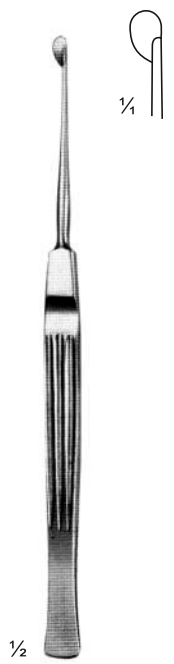

Freer
HP-420-051
 16.5 cm
 Mucosa knife
 Septum knife

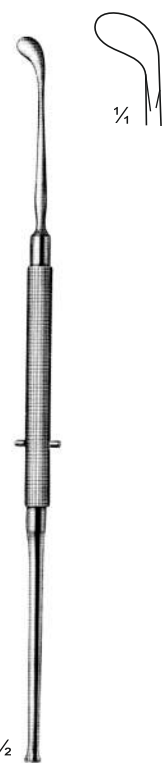

Freer
HP-420-052
 19 cm
 Septum knife

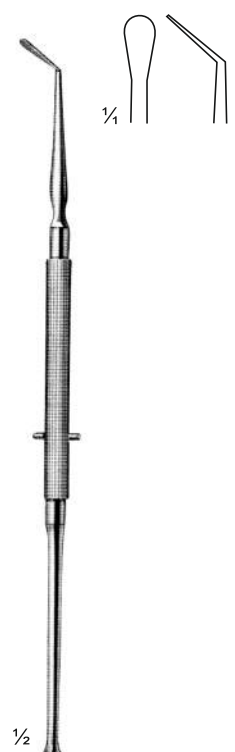

Freer
HP-420-053
 18.5 cm
 Septum knife

Nasal Saws, Cartilage Crusher
Nasensägen, Knorpel-Crusher
Serras Nasais, Triturador de Cartilagem
Sierras nasales, trituradora de cartilago

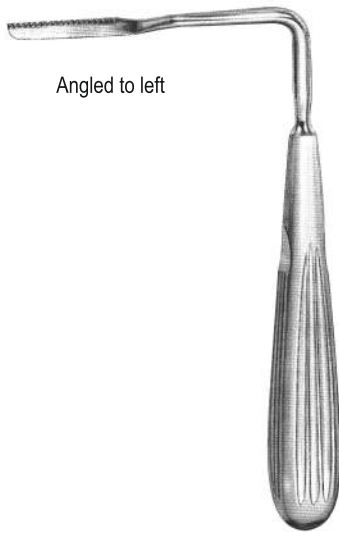

Angled to left

Joseph
HP-421-054
17 cm
Nasal saw

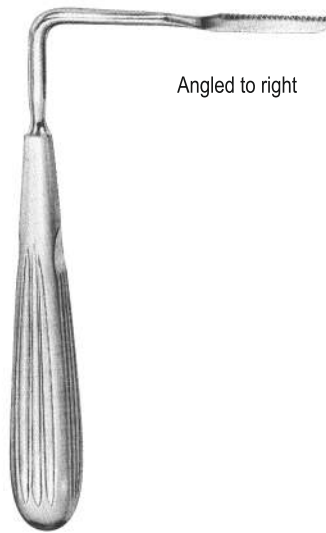

Angled to right

Joseph
HP-421-055
17 cm
Nasal saw



Joseph
HP-421-156 - HP-421-058
19 cm
Nasal saw



HP-421-056
Working length
40 mm

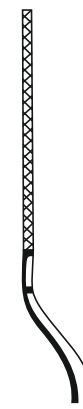

HP-421-057
Working length
40 mm

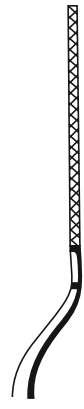

HP-421-058
Working length
40 mm



Cottle
HP-421-059
12 cm
Handle cartilage crusher



Cottle
HP-421-060
Guide support for osteotomes
7 mm wide
Cartilage crusher

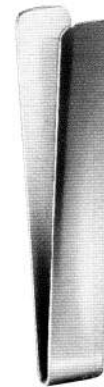

Cottle
HP-421-061
Cartilage crusher
65 x 30 x 30 mm

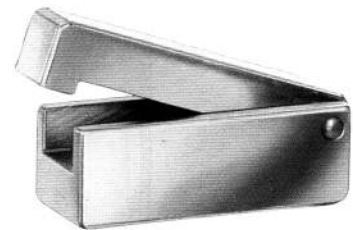

Nasal Rasps, Bone Files, Antrum Rasps
 Nasal Raspeln, Knochenfeilen, Antrum Raspeln
 Raspa Nasal, Arquivos Ósseos, Antrum Rasps
 Escofinas nasales, archivos de hueso, escofinas antro



1/2

Maltz
 HP-422-062 - HP-422-063
 17 cm
 Nasal saw

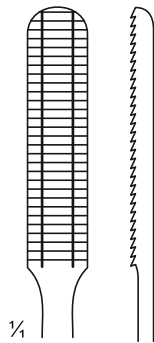

1/4

HP-422-062
 Drawing cut
 34 x 7 mm

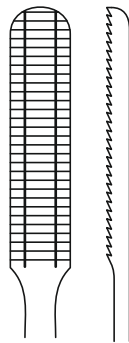

1/4

HP-422-063
 Pushing cut
 34 x 7 mm



1/2

Maltz
 HP-422-064 - HP-422-065
 16 cm
 Bone file



1/4

HP-422-064
 60 x 8 mm

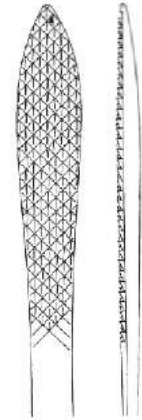

HP-422-065
 45 x 9 mm



1/2

Gallaher
 HP-422-066 - HP-422-1068
 17 cm
 Antrum rasp



1/4

HP-422-066
 45 x 6 mm



HP-422-067
 45 x 6 mm



HP-422-068
 45 x 6 mm

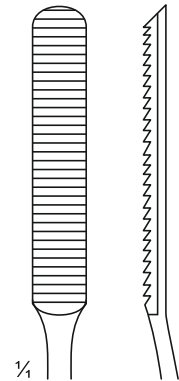

1/4

30 x 8 mm



1/2

Cottle
 HP-422-069
 21 cm
 Nasal rasp

Glabella Rasps, Nasal Rasps, Bone Files

Glabella Raspeln, Nasenraspeln, Knochenfeilen

Raspas de Glabella, Raspa Nasal, Archivos Ósseos

Glabella Rasps, raspados nasales, archivos de hueso



1/2

Aufricht
HP-423-070 - HP-423-071
21 cm
Glabella rasp

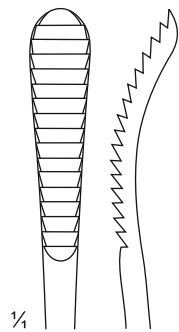

1/4

HP-423-070
Pushing cut
32 x 9 mm

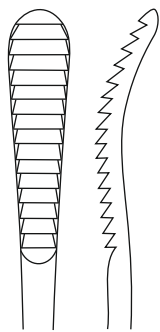

HP-423-071
Drawing cut
32 x 9 mm



1/2

Lweis
HP-423-072 - HP-423-073
19 cm
Nasal rasp

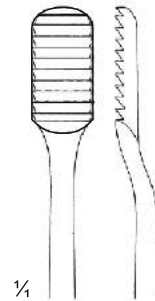

1/4

HP-423-072
Pushing cut
15 x 8 mm

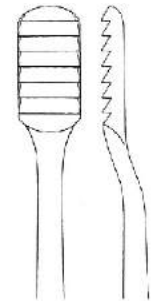

HP-423-073
Drawing cut
15 x 8 mm

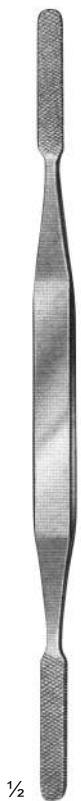

1/2

Fomon
HP-423-074
21 cm
Bone file
30 x 8 mm



1/4

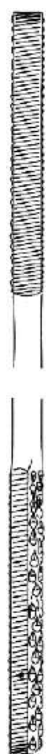

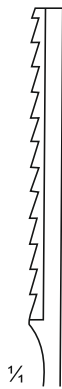

Fig. 1
HP-424-075



Fig. 2
HP-424-076



Fig. 3
HP-424-077



Fig. 4
HP-424-078



Fig. 5
HP-424-079



Fig. 6
HP-424-080



Fig. 7
HP-424-081



Fig. 8
HP-424-082



Fig. 9
HP-424-083



Fig. 10
HP-424-084

Maltz
HP-424-075 - HP-424-084
21 cm

Nasal Rasps
Nasenraspeln
Raspa Nasal
Escofinas nasales

T.C. GOLD

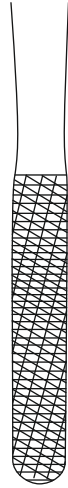
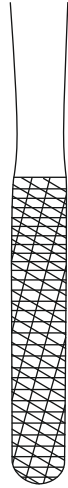
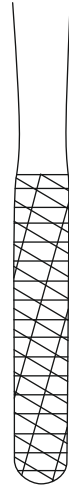
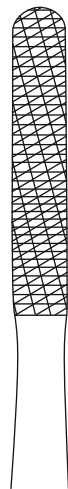
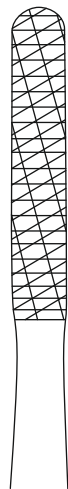
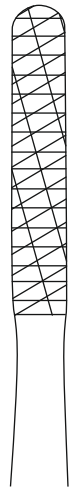
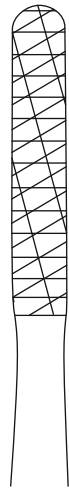
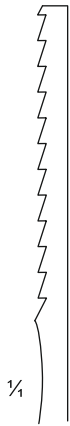

Fig. 1/2
HP-425-085
30 x 8 mm

Fig. 3/4
HP-425-086
40 x 7 mm

Fig. 5/6
HP-425-087
40 x 7 mm

Fig. 7/8
HP-425-088
40 x 7 mm

Fig. 9/10
HP-425-089
40 x 7 mm

Fig. 2/5
HP-425-090
40 x 7 mm

Fomon
HP-425-085 - HP-425-090
20.5 cm

Alar Hooklets, Mucosa Hooklet

Alar-Haken, Mucosa-Haken
Alar Hooklets, Mucosa Hooklet
Alar Hooklets, Mucosa Hooklet



1/2

Kilner
HP-426-091
8 cm
Sharp
Alar hooklet



1/2

Converse
HP-426-092
10.5 cm
Nasal retractor

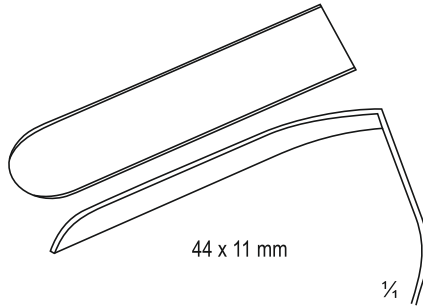

44 x 11 mm

1/4

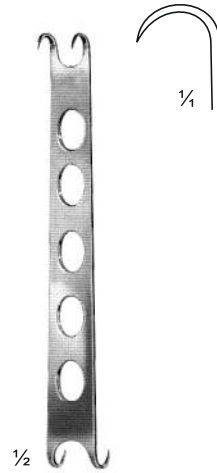

1/2

Converse
HP-426-093
11.5 cm
Sharp
Alar hooklet

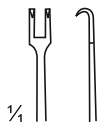

1/4

1/2

Freer
HP-426-094
15 cm
Sharp
Mucosa hooklet



1/2

Joseph
HP-426-095 - HP-426-098
16 cm
Musoca hooklet



1/4

HP-426-095
2 mm



HP-426-096
5 mm



HP-426-097
7 mm



HP-426-098
10 mm

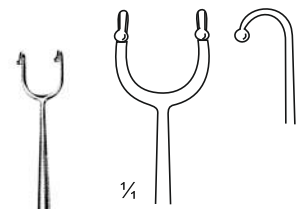

1/2

Fomon
HP-426-099
16 cm
Button ended
Alar hooklet

Alar Hooklets, Nasal Retractors

Alar Hooklets, nasale Retraktoren
Alar Hooklets, retractores nasais
Alar Hooklets, retractores nasales

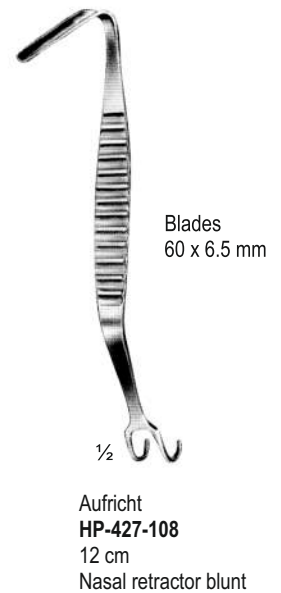
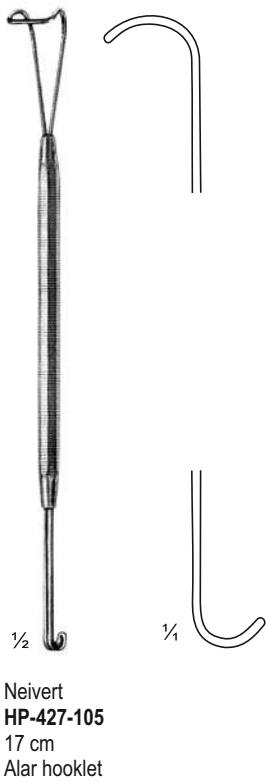
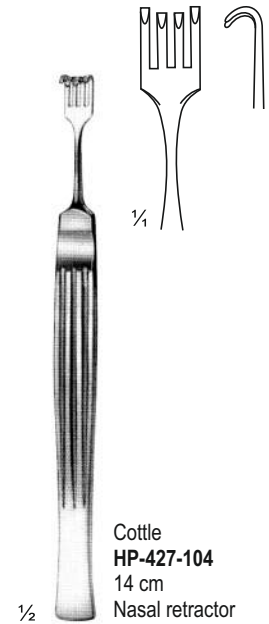
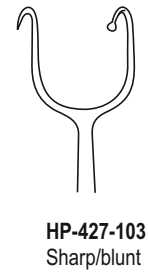
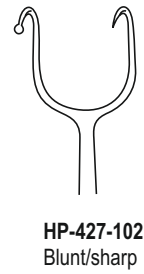
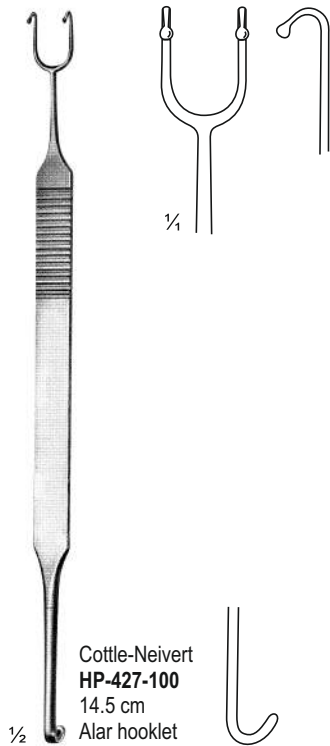

Septum Forceps, Septum Straightening Forceps
 Septumzange, Septum-Richtzange
 Pinça de Septo, Pinça de Endireitamento de Septo
 Pinzas de septo, pinzas de enderezar septos



1/2
 Cottle-Walsham
 HP-428-109 - HP-428-111
 22 cm
 Septum straightening forcep



1/2
 HP-428-109
 Straight

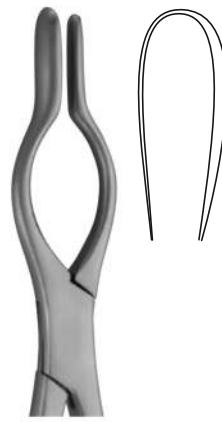

HP-428-110
 Left

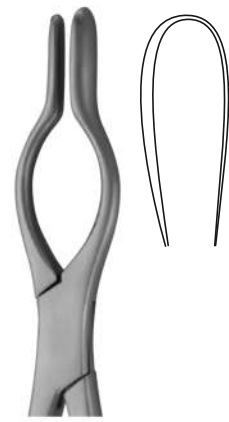

HP-428-111
 Right

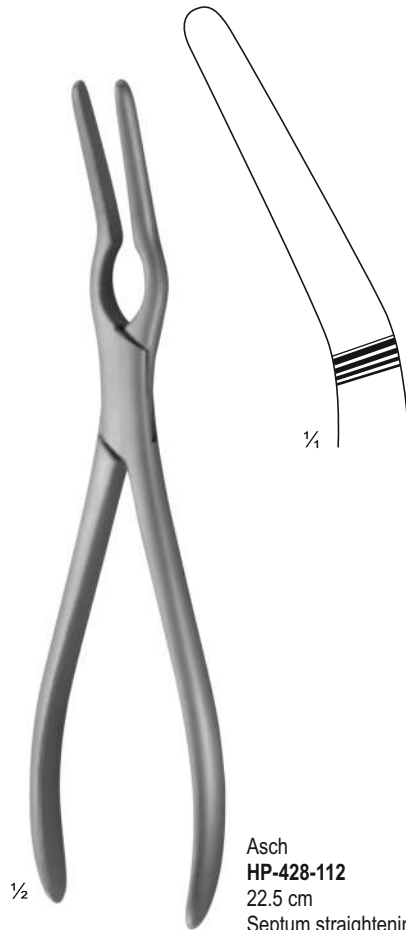

1/2
 Asch
 HP-428-112
 22.5 cm
 Septum straightening forceps



1/2
 Kressner
 HP-428-113
 22 cm
 Septum forcep

Skin Grasping Forceps, Antrum Curettes

Hautgreifpinzetten, Antrum Küretten
Pinça para Agarre a Pele, Curetas Antrum
Fórceps de agarre de piel, curaciones de antrum



Aiach
HP-429-114
15.5 cm
Columella suturing forcep

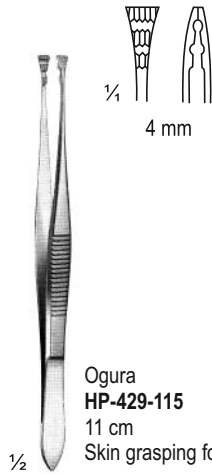

Ogura
HP-429-115
11 cm
Skin grasping forcep

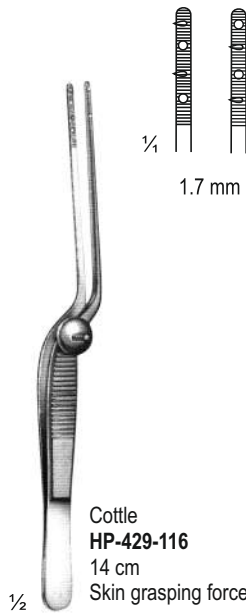

Cottle
HP-429-116
14 cm
Skin grasping forcep

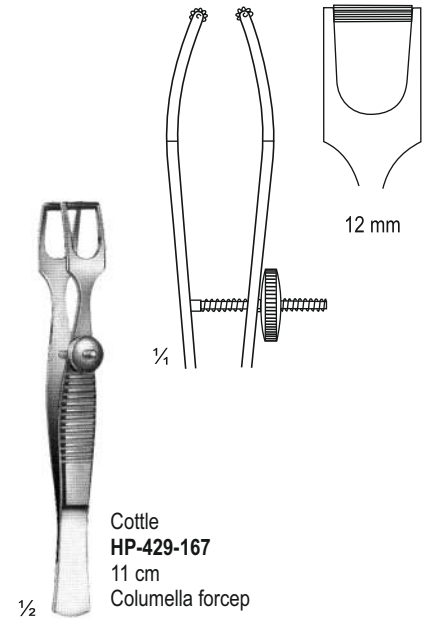

Cottle
HP-429-167
11 cm
Columella forcep

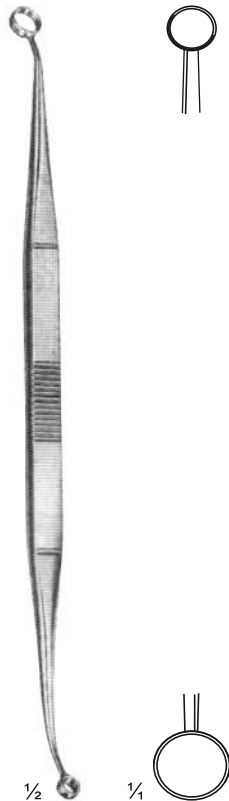

Faulkner
HP-429-118
21 cm
Antrum curette



Coakley
HP-429-119 - HP-429-124
17 cm
Antrum curette



Fig. 1
HP-429-119



Fig. 2
HP-429-120



Fig. 3
HP-429-121



Fig. 4
HP-429-122



Fig. 5
HP-429-123



Fig. 6
HP-429-124

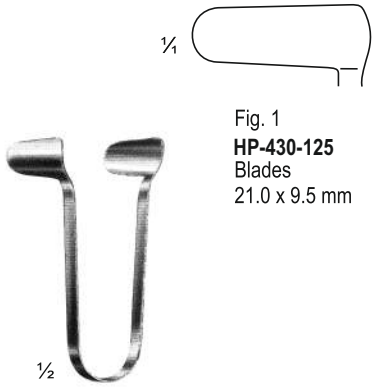

Fig. 1
HP-430-125
Blades
21.0 x 9.5 mm



Fig. 2
HP-430-126
Blades
21.0 x 10.5 mm



Fig. 3
HP-430-127
Blades
21.0 x 11.5 mm

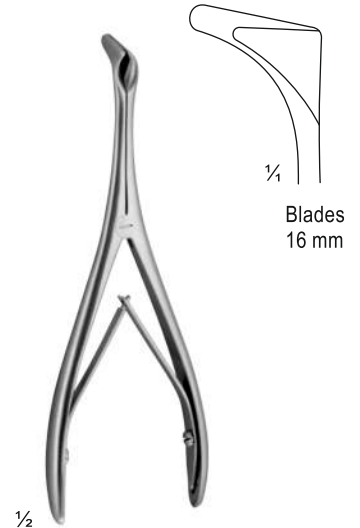

Tieck - Halle
HP-430-128
13 cm

Goldsmith (Thudichum)
HP-430-125 - HP-430-127
6.5 cm



Hartmann-Halle
HP-430-129 - HP-430-131
16 cm

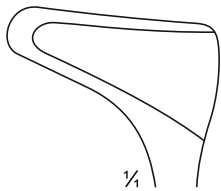

Fig. 1
HP-430-129
blades
27 mm

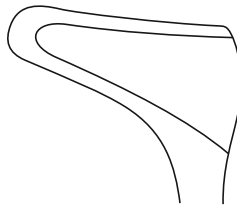

Fig. 2
HP-430-130
blades
31 mm

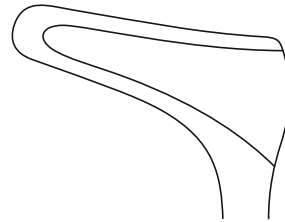

Fig. 3
HP-430-131
blades
35 mm



Beckmann
HP-430-132
15 cm

Nasal Specula

Nasenspecula
Espéculo Nasal
Espéculo nasal



1/2

Mod. Wien
HP-431-133 - HP-431-135
13.5 cm

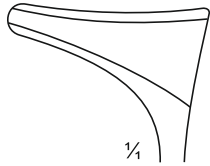

1/4

Fig. 1
HP-431-133
blades
27 mm

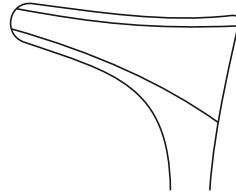

Fig. 2
HP-431-134
blades
31 mm

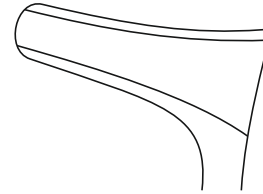
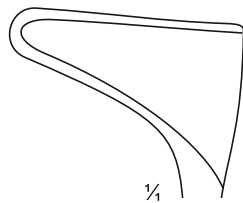

Fig. 3
HP-431-135
blades
35 mm



1/2

Killian
HP-431-139 - HP-431-140



1/4

Fig. 1
HP-431-136
14 cm
Blades
35 mm

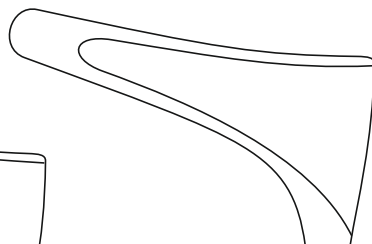

Fig. 2
HP-431-137
14.5 cm
Blades
50 mm

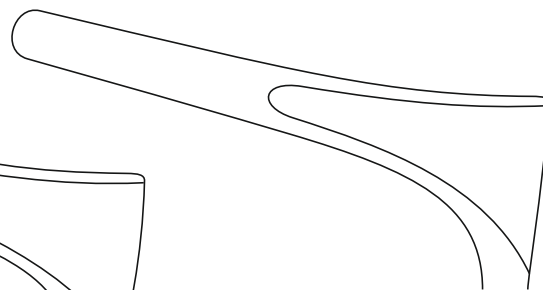

Fig. 3
HP-431-138
16 cm
Blades
75 mm

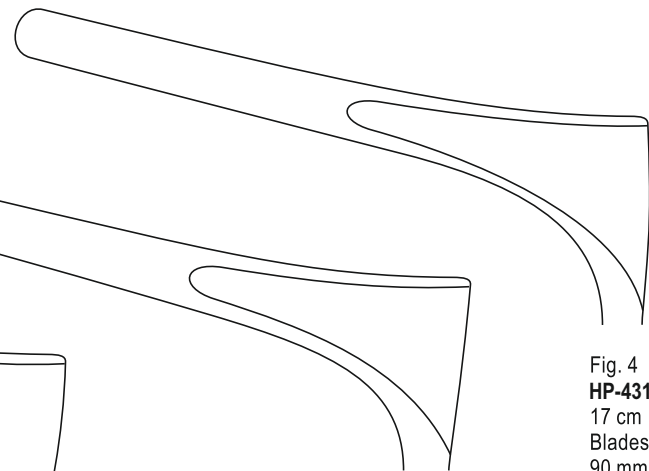

Fig. 4
HP-431-139
17 cm
Blades
90 mm



Oral Maxillo-Facial Surgery

Mund-Kiefer-Gesichtschirurgie

Cirurgia Maxilofacial Oral

Cirugía maxilofacial oral

Page 432-444

Mouth Gags
Mundknebel
Mordaças da boca
Mordazas



½
Molt
HP-432-001
For children
11 cm



½
Molt
HP-432-002
For adults
13 cm



½
Dentart
HP-432-003
13 cm
Jaws
16 mm



½
Fergusson-Ackland
HP-432-004
14.5 cm



½
Roser-König
HP-432-005 - HP-432-006

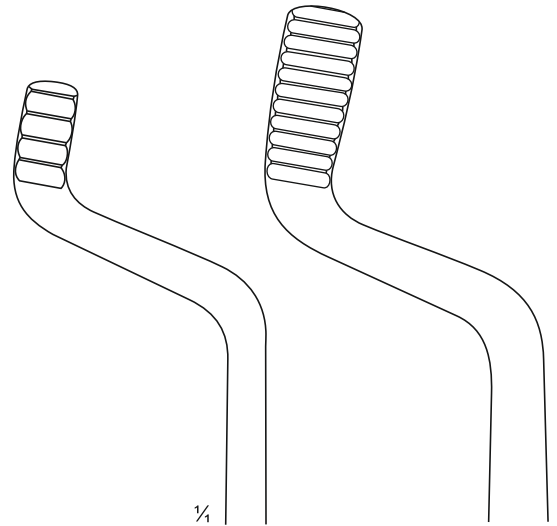

¼
HP-432-005
16 cm

HP-432-006
19 cm



1/2

HP-433-009
14.5 cm
Frame for mouth gag with joint

Davis-Boyle
HP-433-007
Complete, consisting of frame
and 5 tongue depressors no. 1-5

HP-433-008
Frame for mouth gag

HP-433-010
14.5 cm
Silicone inlay



HP-433-011 - HP-433-015
With fixed suction tube

1/2

Fig. 1
HP-433-011
110 X 28 mm



Fig. 2
HP-433-012
95 X 27 mm



Fig. 3
HP-433-013
80 X 27 mm



Fig. 4
HP-433-014
65 X 26 mm



Fig. 5
HP-433-015
30 X 20 mm
Without suction tube

Mouth Gags, Lip and Cheek Retractors

Mundknebel, Lippen- und Wangenspreizer

Gags boca, Lip e bochecha retratores

Mordazas de boca, labios y retractores de mejillas



1/2

Jennings

HP-434-016 - HP-434-019

HP-434-016 10.5 cm

HP-434-017 12.5 cm

HP-434-018 14.5 cm

HP-434-019 16.5 cm

Mouth gag

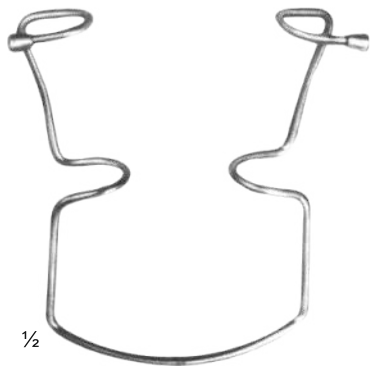

1/2

Oringer

HP-434-020

9.5 cm

Lip and cheek retractor
self retaining, for children

HP-434-020 - HP-434-024

HP-434-021

Set with Fig. 1-3

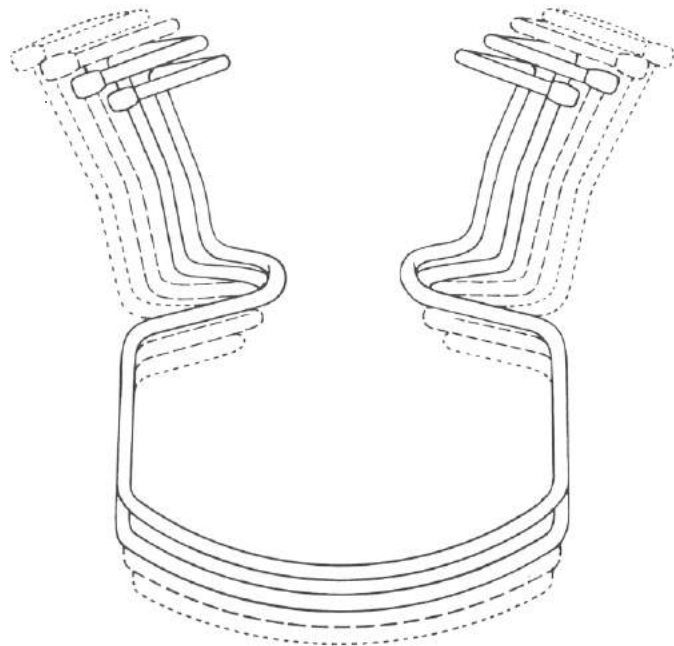

Fig. 1

HP-434-022

10 cm

Fig. 2

HP-434-023

10.5 cm

Fig. 3

HP-434-024

11 cm



1/2

Martin-Simplex
 HP-435-025
 10.5 cm



1/2

HP-435-026
 14 cm
 Vestibulum retractor

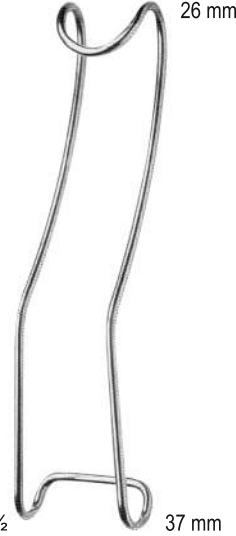

1/2

Sternberg
 HP-435-027
 14 cm



1/2

Obwegeser
 HP-435-028
 12 cm



1/2

Bishop
 HP-435-029
 13.5 cm



1/2

Cawood-Minnesota
 HP-435-030
 15.5 cm



1/2

Cawood-Minnesota
 HP-435-031
 14.5 cm



1/2

Tongue Depressors
Zungenspatel
Depresores de l ngua
Depresores de lengua



1/2

Hartmann
HP-436-032
15 cm

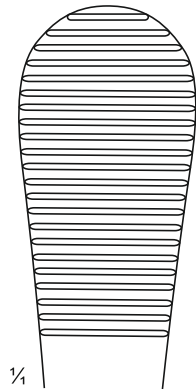

1/4

72 x 24 mm



1/2

Tobold
HP-436-033
15 cm

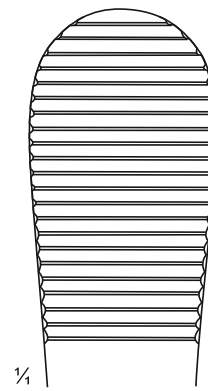

1/4

83 x 25 mm



1/2

Tobold
HP-436-034
16 cm

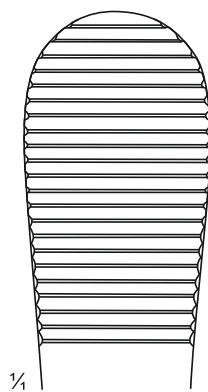

1/4

80 x 25 mm



1/2

Wieder
HP-436-035 - HP-436-036

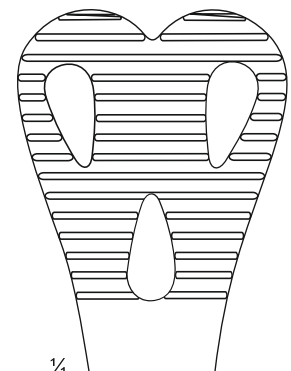

1/4

HP-436-035
14 cm
36 mm

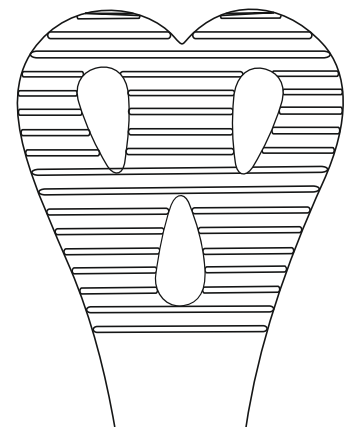

HP-436-036
15 cm
43 mm



1/2

Collin
HP-437-037
 17 cm
 Tongue holding forceps



1/2

Young
HP-437-038
 15 cm
 Tongue holding forceps

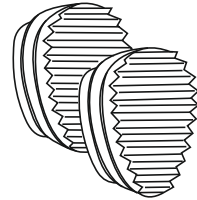

Young
HP-437-039
 Rubber inserts
 pair



HP-437-038

9.5/16 mm



1/2

HP-437-040
 22 cm
 Extra oral retractors
 Concave, fully bent tip



1/2

Eckelt
HP-437-041
 21 cm
 Extra oral retracots

1/4

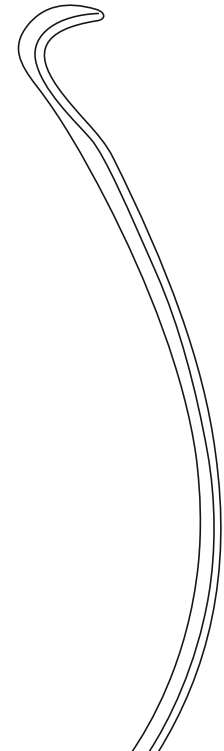
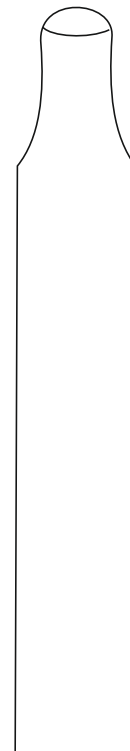

Extra Oral Retractors

Extra Oral Retraktoren
Retratores orais extra
Retradores orales extra

9.5/16 mm



HP-438-042
25 cm
Concave, full bent tip



Eckelt
HP-438-043
25 cm
Concave, full bent tip

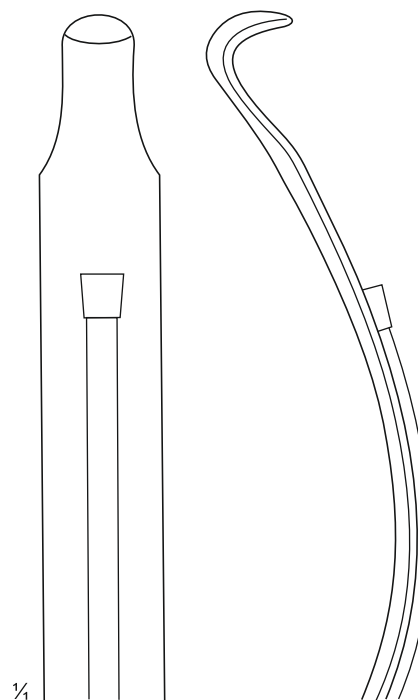



HP-439-044
23 cm
for leFort osteotomies
25.5 mm



HP-439-045
26 cm
For leFort osteotomies
25.5 mm

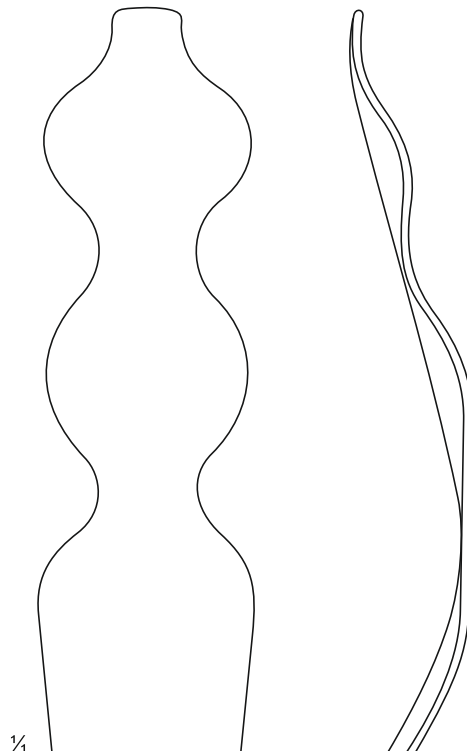

Soft Tissue Retractors

Weichteil-Retraktoren

Retradores de tecidos moles

Retradores de tecidos moles



1/2

Obwegeser
HP-440-046 - HP-440-048

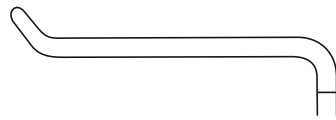

HP-440-046
22.5 cm
43 X 11 mm

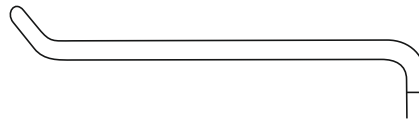

HP-440-047
23 cm
57 X 11 mm

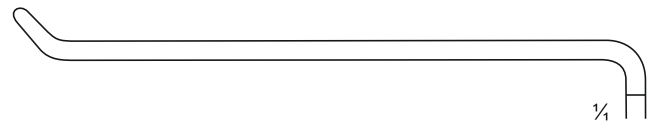

1/4

HP-440-048
23 cm
80 X 16 mm



1/2

Obwegeser
HP-440-049
22 cm
Nasal spine retractor

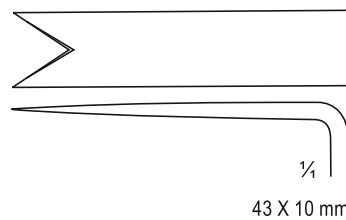

1/4

43 X 10 mm

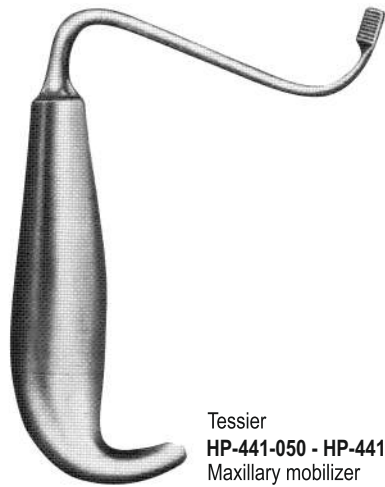

Tessier
HP-441-050 - HP-441-051
 Maxillary mobilizer
 zygoma elevator



1/4

HP-441-050
 Left



1/4

HP-441-051
 Right

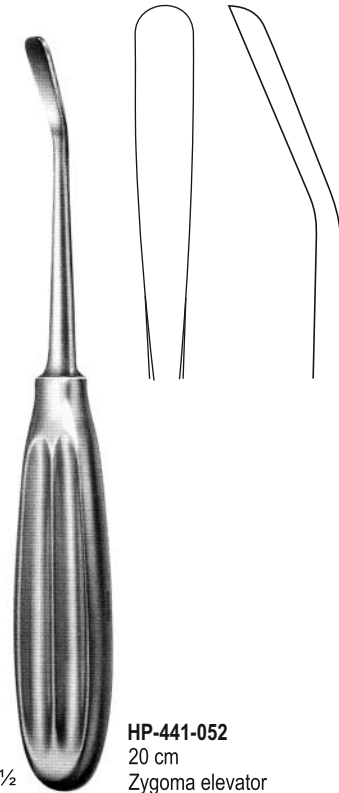

1/2

HP-441-052
 20 cm
 Zygoma elevator



1/2

Dingmann
HP-441-053
 21.5 cm
 Zygoma
 elevator

Tip
 Ø 5.0 mm



1/2

Dingmann-Wilk
HP-441-054
 20 cm
 Retractor



1/2

Eckelt
HP-441-055
 20 cm
 Plate-pulling instrument

Bone Holding Forceps

Knochenhaltezange
Osso, segurando, fórceps
Fórceps de sujeción de hueso

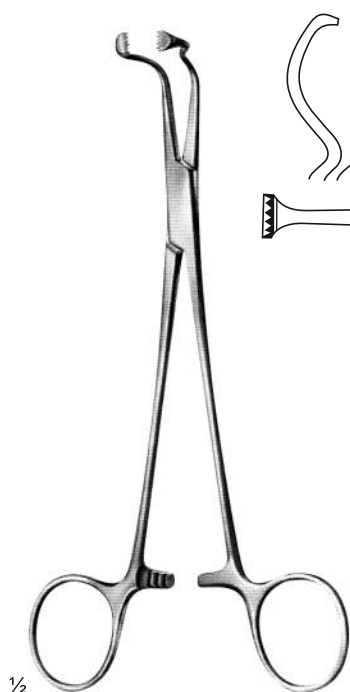

1/2
Keen
HP-442-056 - HP-442-057
17.5 cm

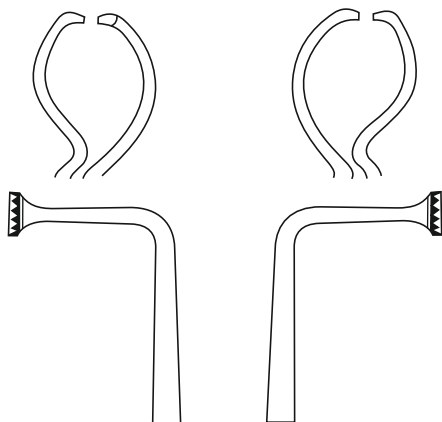

HP-442-056
Left
HP-442-057
Right



1/2
Steinhäuser
HP-442-058
13.5 cm



1/2
Steinhäuser
HP-442-059
12.5 cm

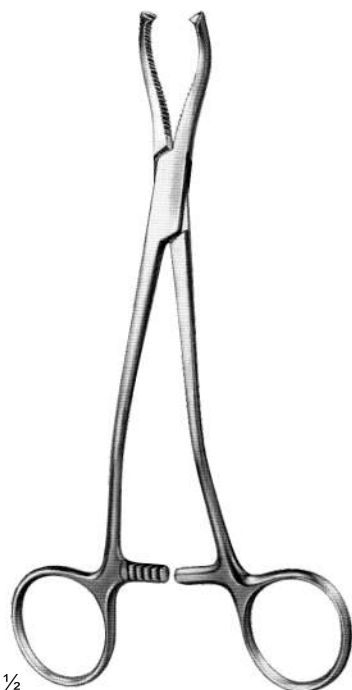

1/2
Jeter-Van Sickels
HP-442-060 - HP-442-061
17.5 cm

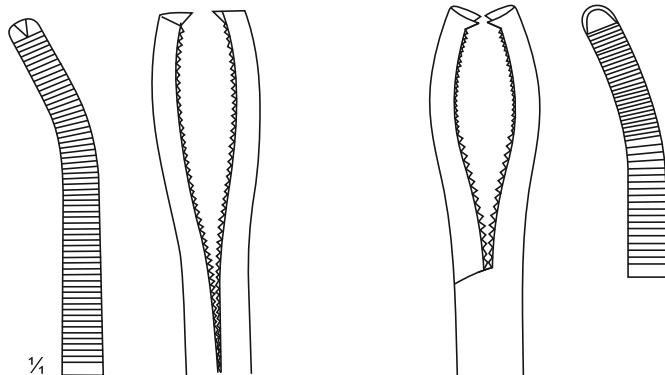

HP-442-060
19.5 cm
Light pattern, for
sagittal split procedure



1:2

HP-442-061
18 cm
Heavy pattern, for
sagittal split procedure



2:2

Raspatories, Osteotomes

Raspatorien, Osteotome
 Raspatórios, Osteótomos
 Raspatories, Osteotomes

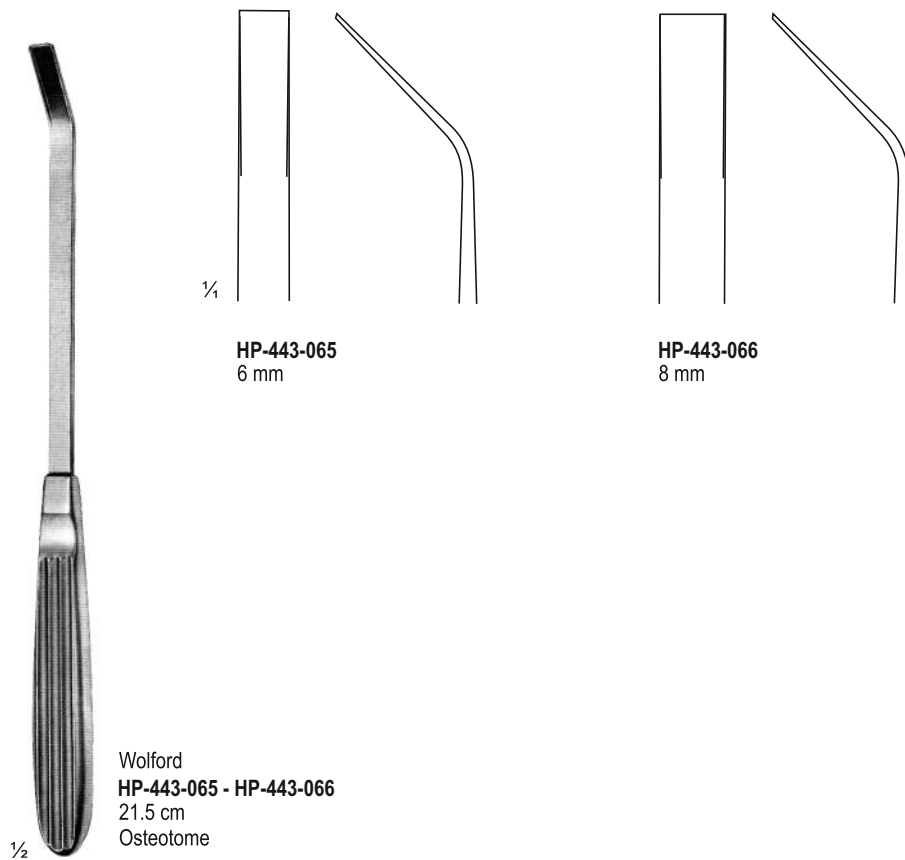
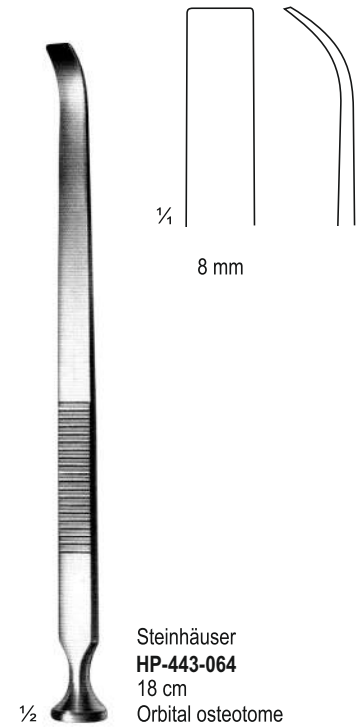
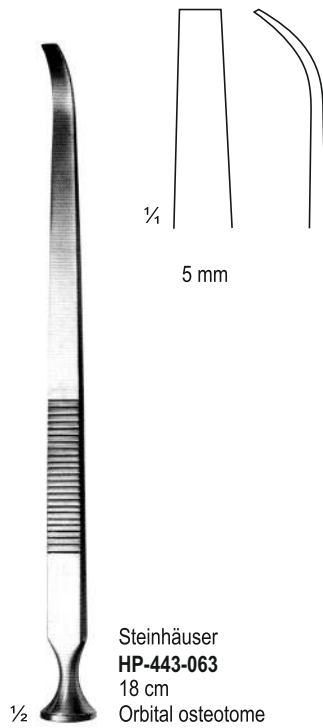
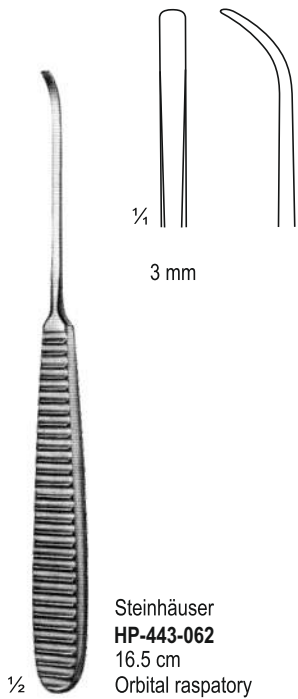



Tonsillectomy, Laryngo-Bronchoscopy

Tonsillektomie, Laryngo-Bronchoskopie

Amigdalectomia Laryngo-broncoscopia

Amigdalectomía, laringoscocoscopia

Page 445-449

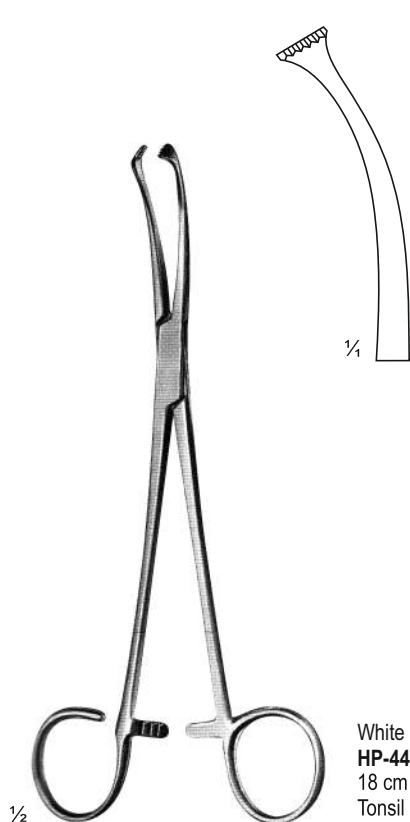

White
HP-445-001
18 cm
Tonsil grasping forceps

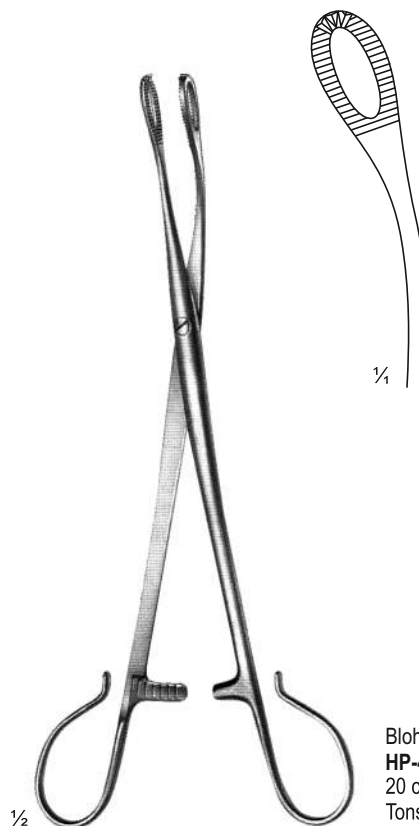

Blohmke
HP-445-002
20 cm
Tonsil grasping forceps

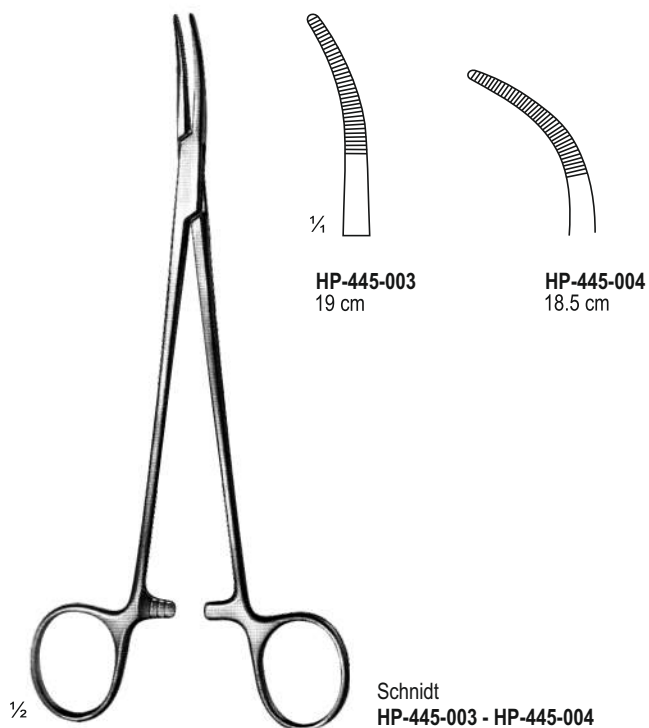

HP-445-003
19 cm

HP-445-004
18.5 cm

Schnidt
HP-445-003 - HP-445-004

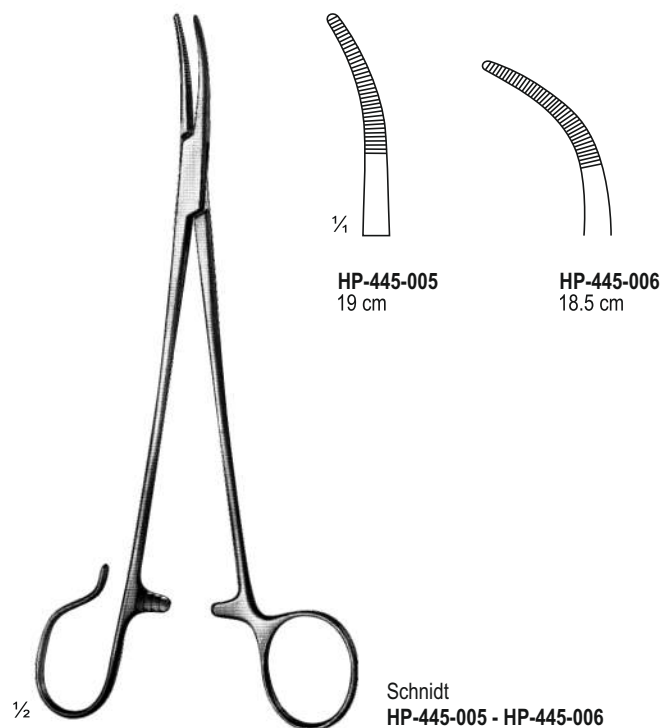

HP-445-005
19 cm

HP-445-006
18.5 cm

Schnidt
HP-445-005 - HP-445-006

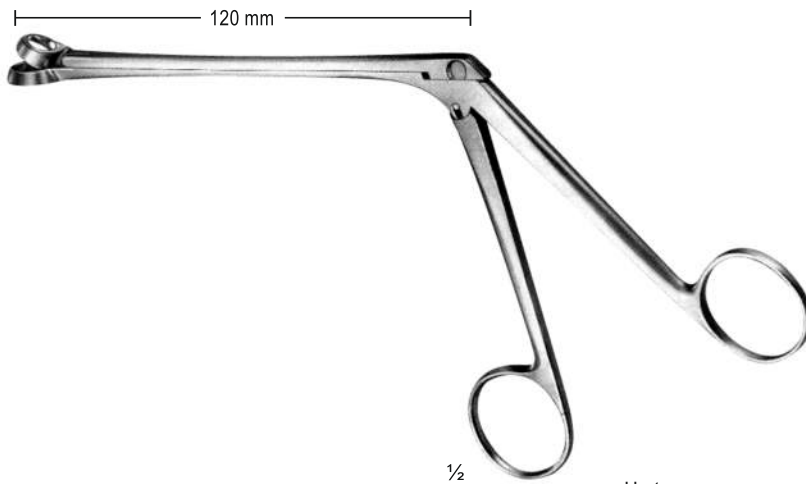

Hartmann
HP-446-007 - HP-446-008
 Tonsil punch through-cutting

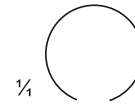

HP-446-007
 Cut
 13 mm Ø

Shaft length
 120 mm Ø

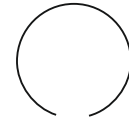

HP-446-008
 Cut
 15 mm Ø

Shaft length
 120 mm Ø



Brünings
HP-446-010 - HP-446-011
 Interchangeable tube
 for handle **HP-446-029**

HP-446-012 22 cm
HP-446-013 32 cm
HP-446-014 41 cm



Huber
HP-446-009
 Universal handle
 for interchangeable tube
HP-446-009 - HP-446-010

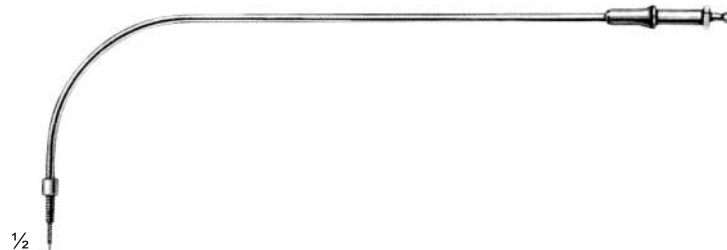

Brünings
HP-446-010
 18 cm
 laryngeal tube, curved
 for handle **HP-446-009**



Fraenkel
HP-447-015
For interchangeable tubes

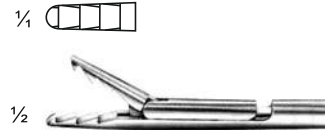

Seiffert
HP-447-016
For interchangeable tubes

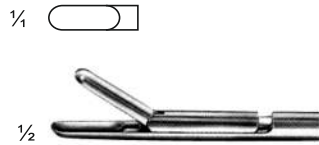

Fraenkel
HP-447-017
For interchangeable tubes

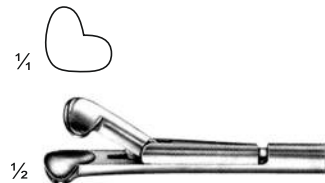

Scheinmann
HP-447-018
For interchangeable tubes

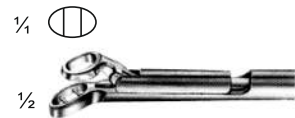

Scheinmann
HP-447-019
For interchangeable tubes



Brünings
HP-447-020 - HP-447-021
For interchangeable tubes

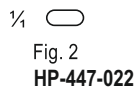
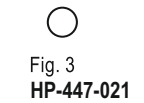
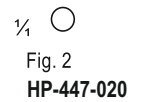

Fig. 2
HP-447-022

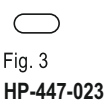

Fig. 3
HP-447-023



Brünings
HP-447-022 - HP-447-023
for interchangeable tubes



Lange
HP-447-024
for interchangeable tubes

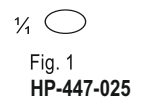

Fig. 1
HP-447-025



Krause
HP-448-026 - HP-448-027
For interchangeable tubes



Fig. 1
HP-448-026



Fig. 2
HP-448-027



Krause
HP-448-035
For interchangeable tubes



Cordes
HP-448-028 - HP-448-031
For interchangeable tubes



Fig. 1
HP-448-028



Fig. 2
HP-448-029



Fig. 3
HP-448-030



Fig. 4
HP-448-031



Schumacher
HP-448-036
For interchangeable tubes



Cordes
HP-448-032 - HP-448-033
For interchangeable tubes



Fig. 1
HP-448-032



Fig. 2
HP-448-033



Cordes
HP-448-037
For interchangeable tubes



Rosenberg
HP-448-034
For interchangeable tubes



Cranio-Maxillo-Facial Surgery

Cranio-Maxillo-Gesichtschirurgie

Cirurgia Cranio-Maxilo-Facial

Cirugía cráneo-maxilar-facial

Page 450-464

Soft Tissue Retractors
Weichteil-Retraktoren
Retradores de tejidos moles
Retradores de tejidos blandos



Obwegeser
HP-450-001 - HP-450-007
Bent upwards

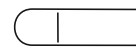

HP-450-001
21.5 cm
16 x 5 mm



HP-450-002
21 cm
25 x 7 mm



HP-450-003
23 cm
35 x 10 mm



HP-450-004
23 cm
42 x 10 mm



HP-450-005
23.5 cm
55 x 13 mm

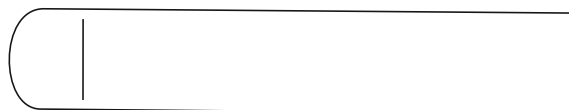

HP-450-006
23.5 cm
67 x 15 mm



HP-450-007
24 cm
80 x 17 mm



Obwegeser
HP-451-008 - HP-451-014
Bent upwards



HP-451-008
21 cm
16 x 5 mm



HP-451-009
21 cm
25 x 7 mm



HP-451-010
23 cm
35 x 10 mm



HP-451-011
23 cm
42 x 10 mm



HP-451-012
23.5 cm
55 x 12 mm



HP-451-013
23.5 cm
66 x 15 mm



HP-451-014
23.5 cm
80 x 16 mm

Ramus Clamps, Channel Retractors
Ramus-Klammern, Kanal-Retraktoren
Grampos Ramus, Retradores de Canal
Ramus Clamps, Channel Retractors



Obwegeser
HP-452-015
16.5 cm
Small pattern, right
Ramus clamp



Obwegeser
HP-452-016
17 cm
Large pattern, right
Ramus clamp



Obwegeser
HP-452-017
16.5 cm
Small pattern, Left
Ramus clamp

Obwegeser
HP-452-018
17 cm
Large pattern, Left
Ramus clamp

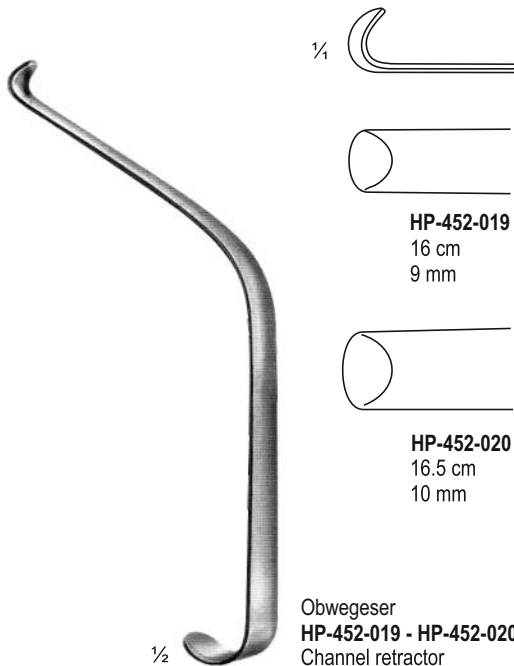

HP-452-019
16 cm
9 mm

HP-452-020
16.5 cm
10 mm

Obwegeser
HP-452-019 - HP-452-020
Channel retractor

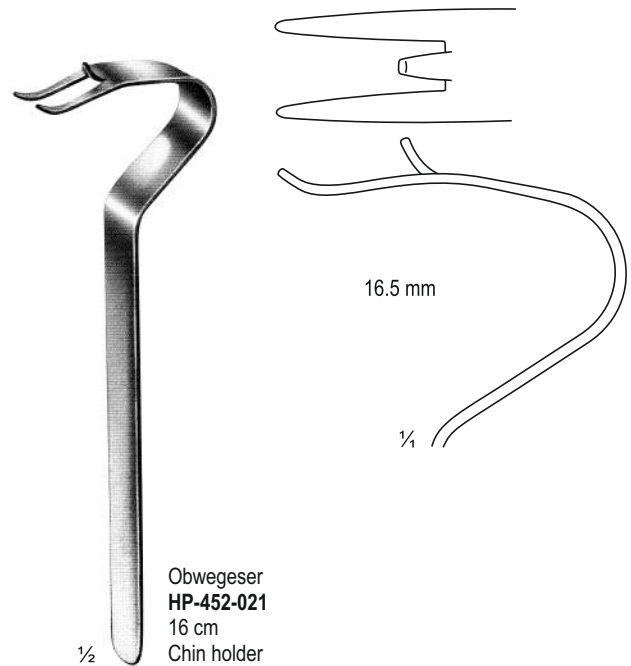

Obwegeser
HP-452-021
16 cm
Chin holder

Mandibular Inferior Border Raspatories, Swallowtail Raspatories
 Unterkiefer Raspatories, Schwalbenschwanz Raspatories
 Raspatórios Inferior Mandibulares da Borda, Raspatórios Swallowtail
 Raspator de borde inferior mandibular, raspadores de cola de golondrina



Obwegeser
HP-453-022
 21 cm
 Elevator



Obwegeser
HP-453-023
 21 cm
 Periosteal Elevator

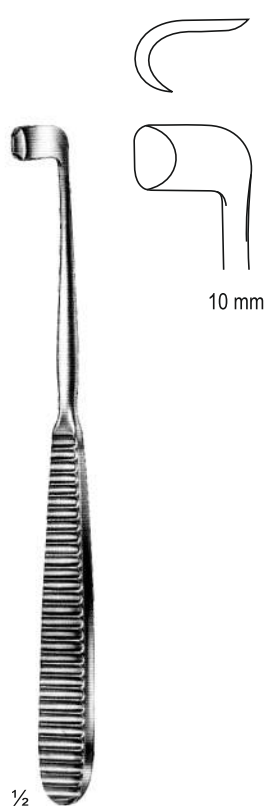

Obwegeser
HP-453-024
 18 cm
 Angled to left

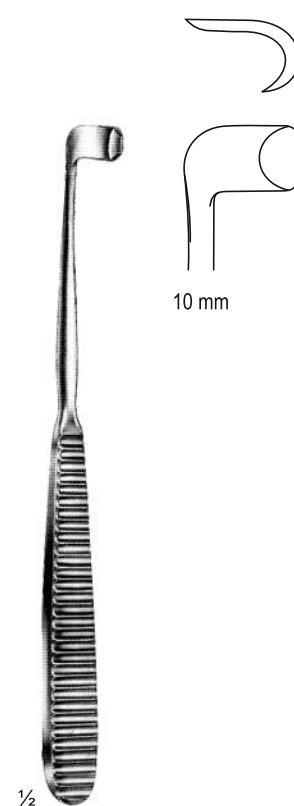

Obwegeser
HP-453-025
 18 cm
 Right to left

Mandibular inferior border raspatories

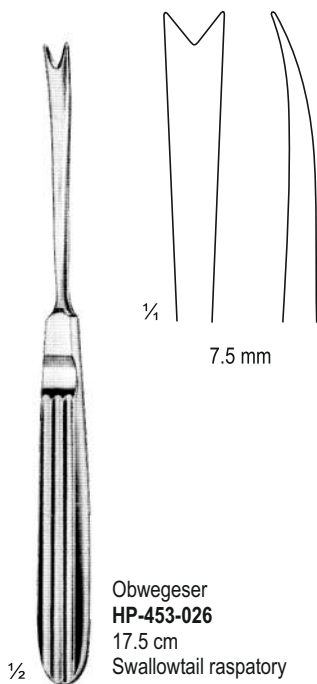

Obwegeser
HP-453-026
 17.5 cm
 Swallowtail raspatory

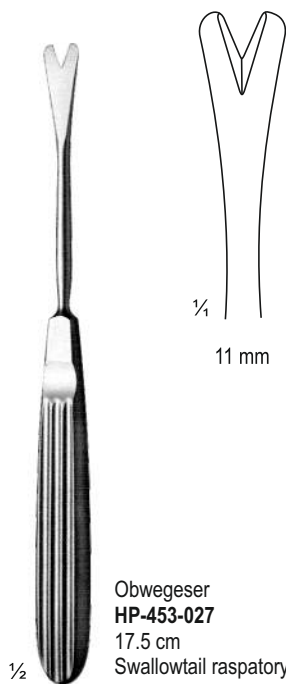

Obwegeser
HP-453-027
 17.5 cm
 Swallowtail raspatory

Wedge Osteotomes, Blade Osteotomes

Keil Osteotome, Blade Osteotome
Osteótomos de Cunha, Osteótomos de Lâmina
Osteótomos de cuña, osteótomos de cuchilla



1/2

Obwegeser
HP-454-028 - HP-454-031
22.5 cm
Wedge osteotome



1/4

HP-454-028
8 mm

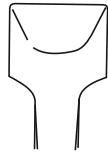

HP-454-029
12 mm

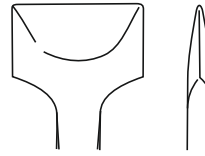

HP-454-031
16 mm

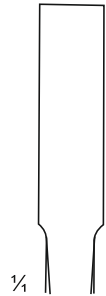

1/4

HP-454-032
8 mm

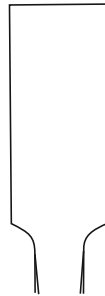

HP-454-033
12 mm

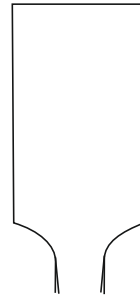

HP-454-034
16 mm

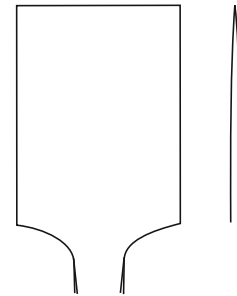

HP-454-035
20 mm



1/2

Obwegeser
HP-454-032 - HP-454-035
22.5 cm
Blade osteotome

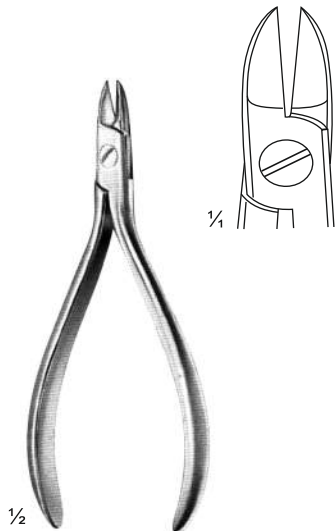

Obwegeser
HP-455-036
 12 cm
 Wire cutter



Obwegeser
HP-455-037 - HP-455-039
 Wire twisting forceps

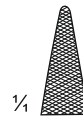

HP-455-037
 12.5 cm

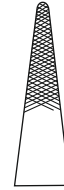

HP-455-038
 13 cm

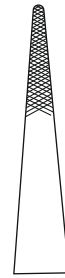

HP-455-039
 15 cm

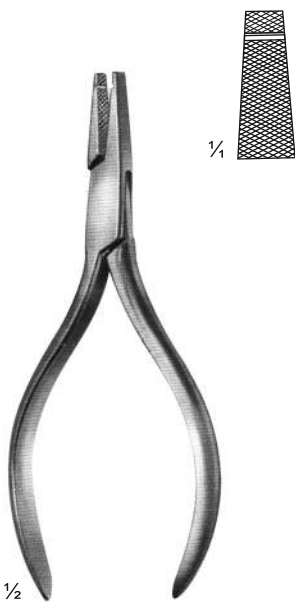

Obwegeser
HP-455-040
 13 cm
 Flat nose pliers

TC GOLD



Obwegeser
HP-455-041 - HP-455-042
 13 cm
 Wire twisting forceps



HP-455-041



HP-455-042
 wide jaw

Bone Contouring Forceps, Skin Hooklet, Scalp Clamp

Bone Contouring Pinzetten, Skin Hooklet, Kopfhautklammer

Pinça de contorno ósseo, gancho de pele, grampo do couro cabeludo

Pinzas para modelar huesos, gancho para la piel, pinza para el cuero cabelludo

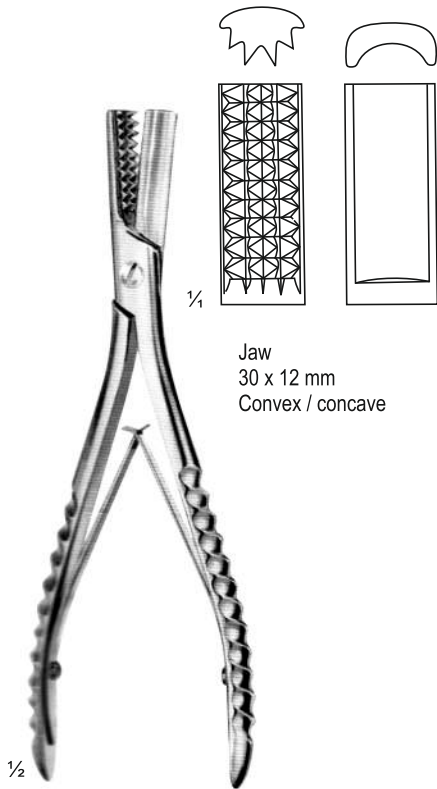

Jaw
30 x 12 mm
Convex / concave

Obwegeser
HP-456-043
18 cm
Bone contouring forceps

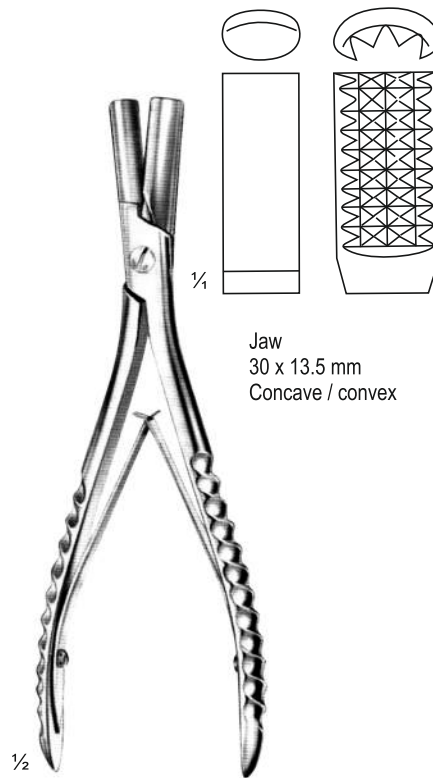

Jaw
30 x 13.5 mm
Concave / convex

Obwegeser
HP-456-044
18 cm
Bone contouring forceps

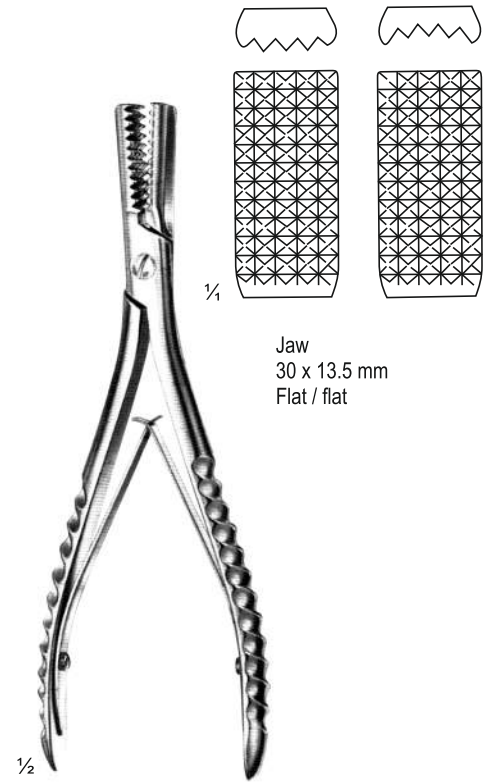

Jaw
30 x 13.5 mm
Flat / flat

Obwegeser
HP-456-045
18 cm
Bone contouring forceps



Tessier
HP-456-046
19 cm
Sharp
Skin hooklet

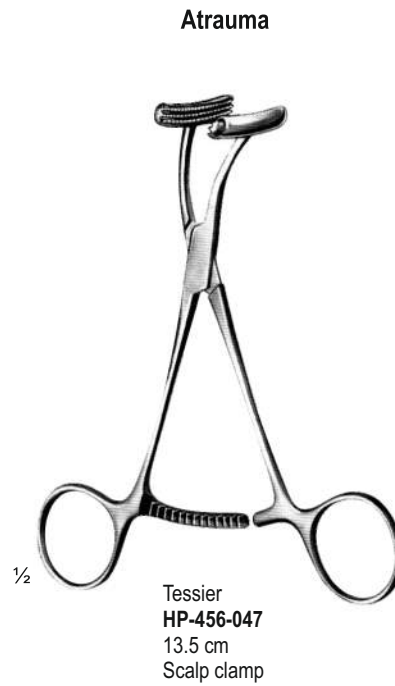

Atrauma
Tessier
HP-456-047
13.5 cm
Scalp clamp

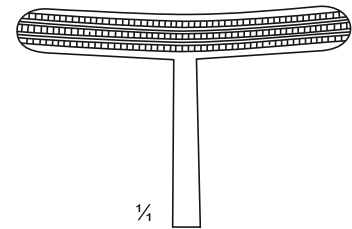

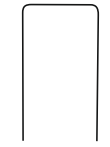
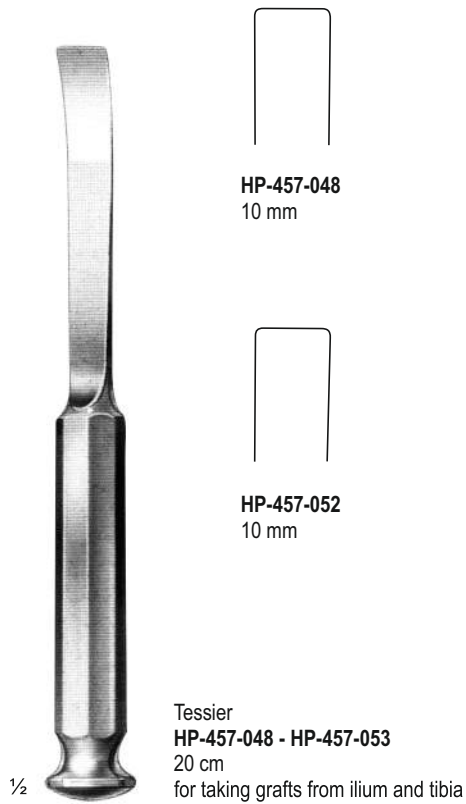

HP-457-048
10 mm

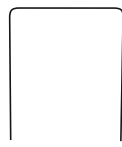

HP-457-049
15 mm

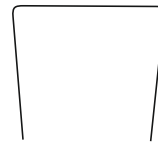

HP-457-050
20 mm

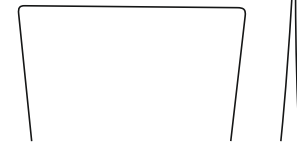

HP-457-051
30 mm

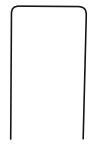

HP-457-052
10 mm

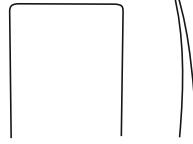

HP-457-053
15 mm

Tesser
HP-457-048 - HP-457-053
20 cm
for taking grafts from ilium and tibia

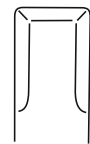
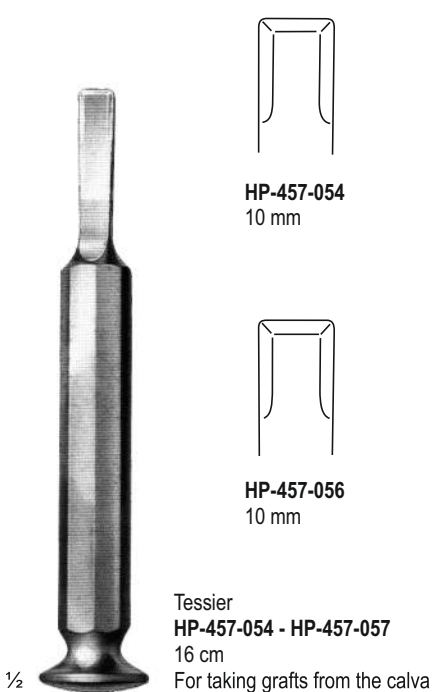

HP-457-054
10 mm

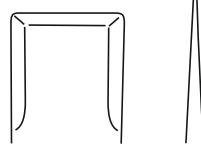

HP-457-055
15 mm



HP-457-056
10 mm

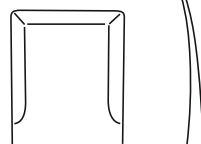

HP-457-057
15 mm

Tesser
HP-457-054 - HP-457-057
16 cm
For taking grafts from the calva

Bone Holding Forceps, Bone Cutting Forceps

Knochenhaltezange, Knochenschneidezange

Fórceps de soporte ósseo, Fórceps de corte ósseo

Fórceps de sujeción de hueso, fórceps de corte de hueso

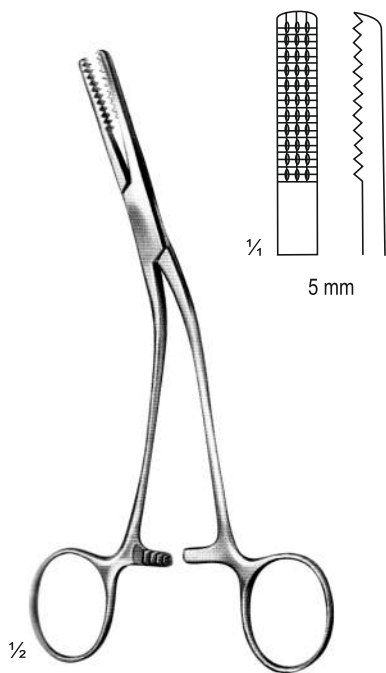

Tessier
HP-458-058
16.5 cm
Bone holding forcep

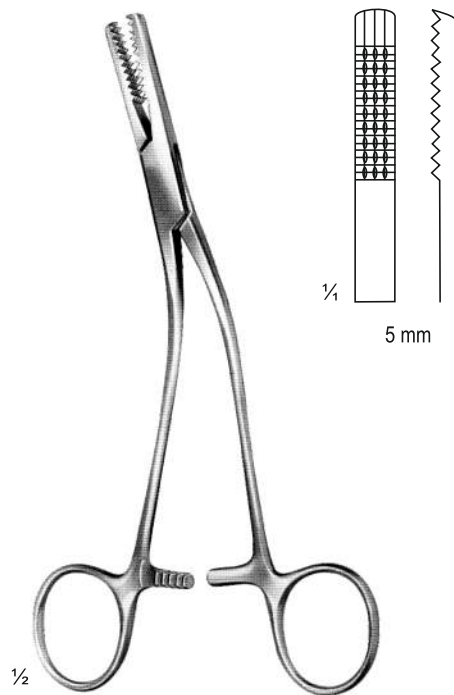

Tessier
HP-458-059
18 cm
Bone holding forcep

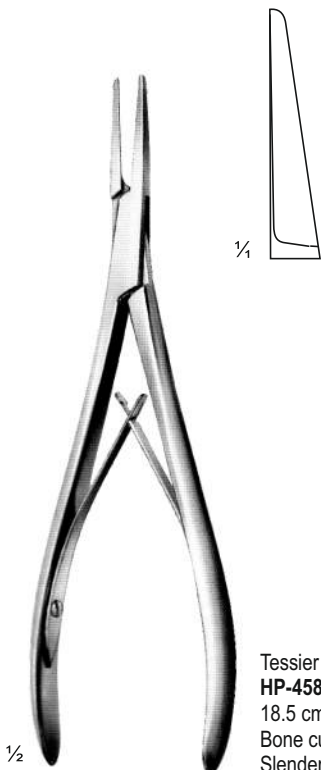

Tessier
HP-458-060
18.5 cm
Bone cutting forcep
Slender pattern

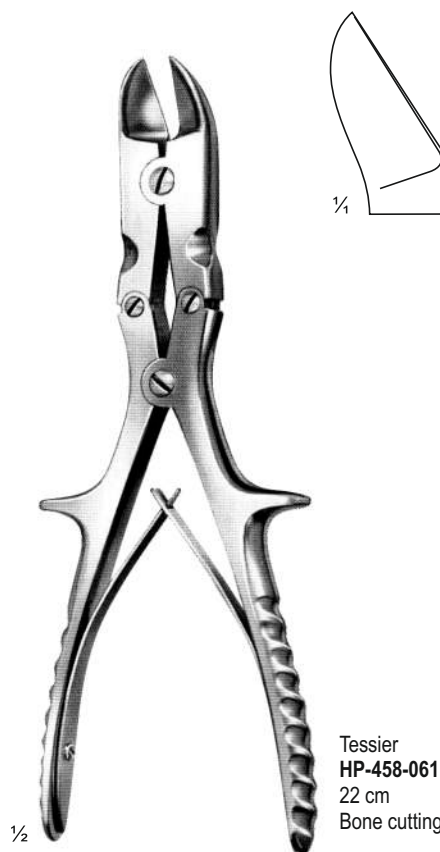

Tessier
HP-458-061
22 cm
Bone cutting forcep

Bone Contouring Forceps, Periosteal Elevators, Awls

Bone Contouring Forceps, Periosteale Elevatoren, Ahlen
 Pinça de Contorno dos Ossos, Elevadores Periosteais, Lâminas
 Pinzas para contornear óseas, elevadores periósticos, punzones

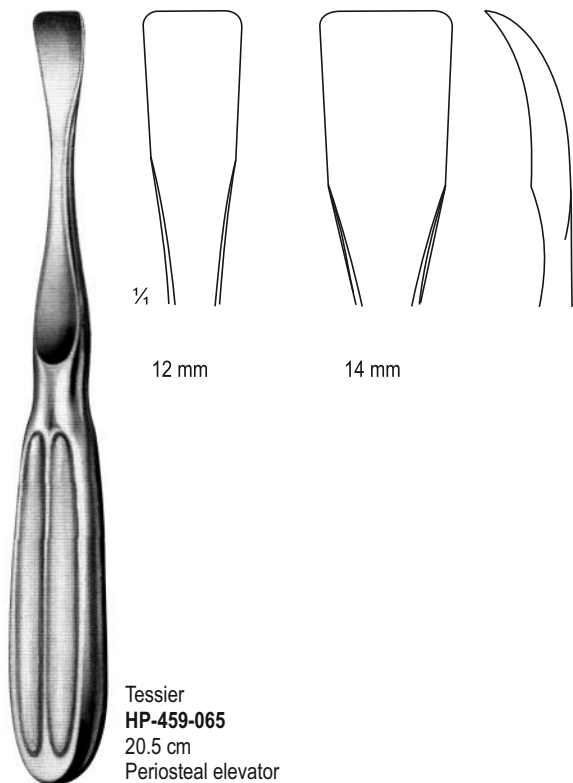
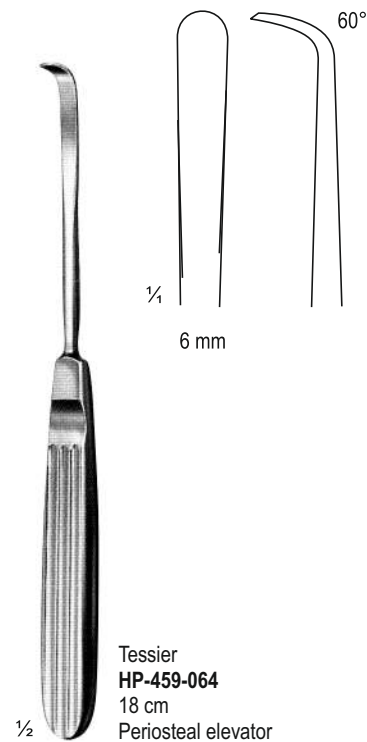
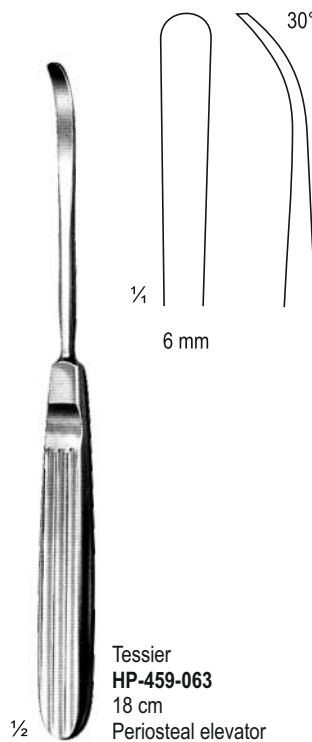
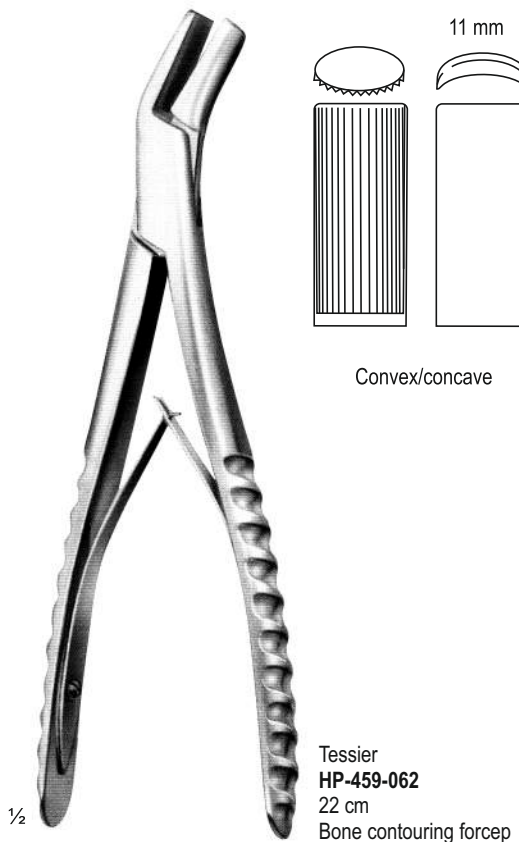

Soft Tissue Retractors

Weichteil-Retraktoren
Retratores de tecidos moles
Retradores de tejidos blandos

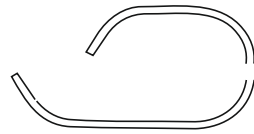

HP-460-070
15 cm
20 x 13 / 30 x 15 mm

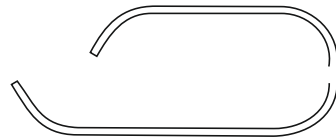

HP-460-071
15.5 cm
28 x 13 / 36 x 15 mm

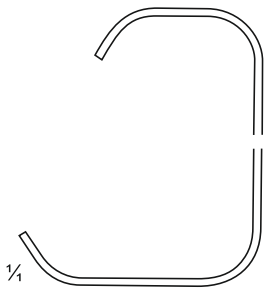

19 x 7 / 29 x 10 mm

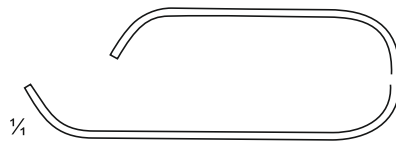

HP-460-072
15.5 cm
33 x 12 / 43 x 15 mm

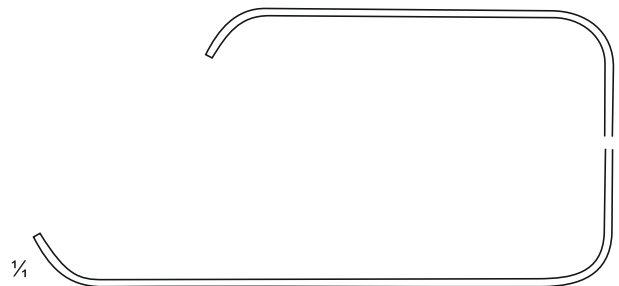

50 x 12 / 68 x 16 mm



Tessier
HP-460-069
15 cm
Black chromium-plated



Tessier
HP-460-070 - HP-460-072
Black chromium-plated



Tessier
HP-460-073
16 cm
Black chromium-plated

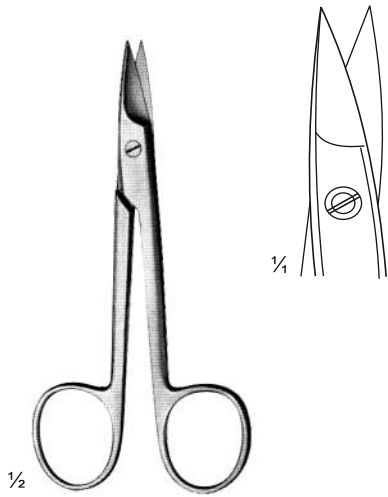

Tessier
HP-461-074
 12 cm
 Wire cutting scissors

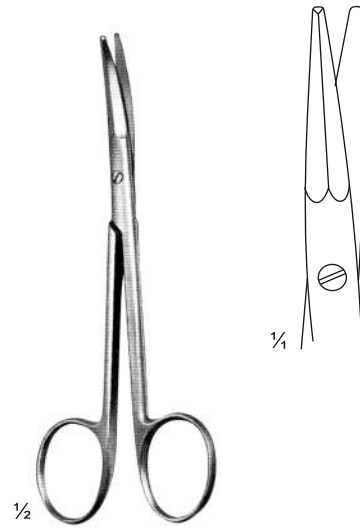

Tessier
HP-461-075
 13 cm
 Undermining scissors

TC GOLD

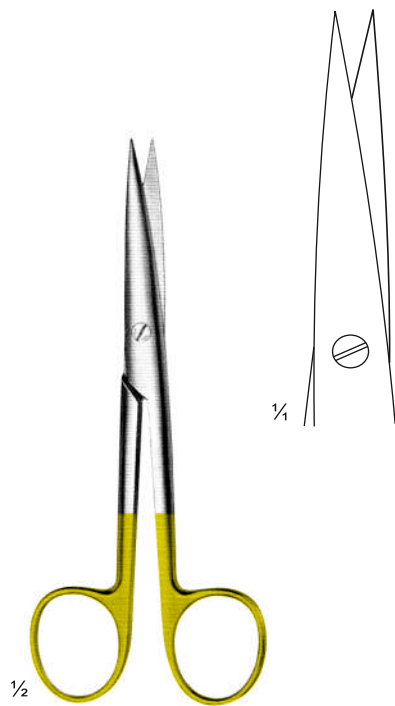

Tessier
HP-461-076
 15 cm
 Dissecting scissors

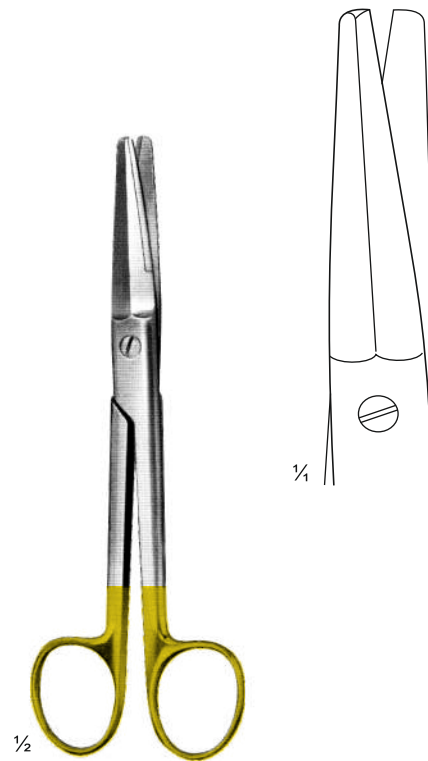

Tessier
HP-461-077
 16.5 cm
 Dissecting scissors

Mobilizing Retractors, Periosteal Elevators

Retraktoren mobilisieren, Periostale Aufzüge
Retratores de Mobilização, Elevadores Periosteais
Retradores movilizadores, elevadores periósticos

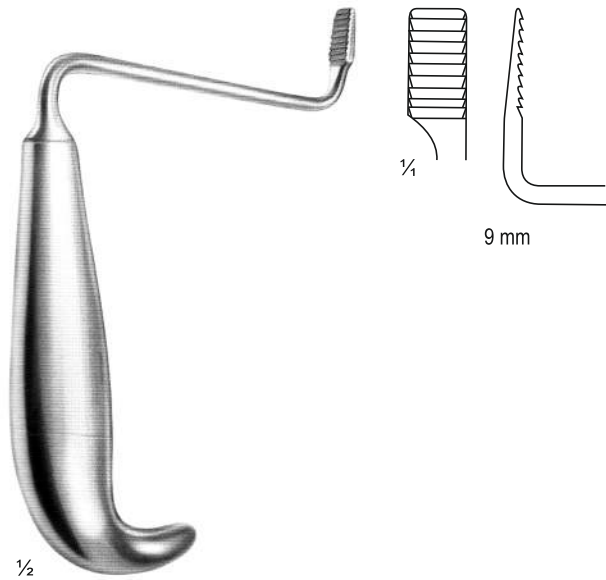

1/2

Tessier
HP-462-078
15 cm
Right
Mobilizing retractor

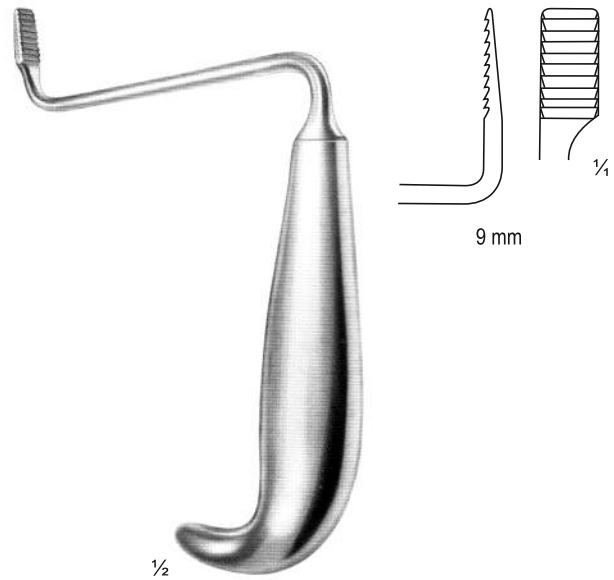

1/2

Tessier
HP-462-079
15 cm
Left
Mobilizing retractor

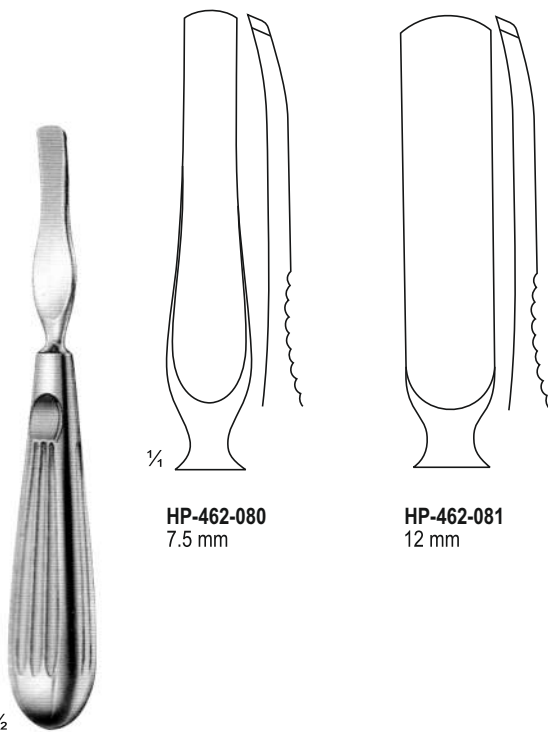

1/2

Marchac
HP-462-080 - HP-462-081
16 cm
Periosteal elevator

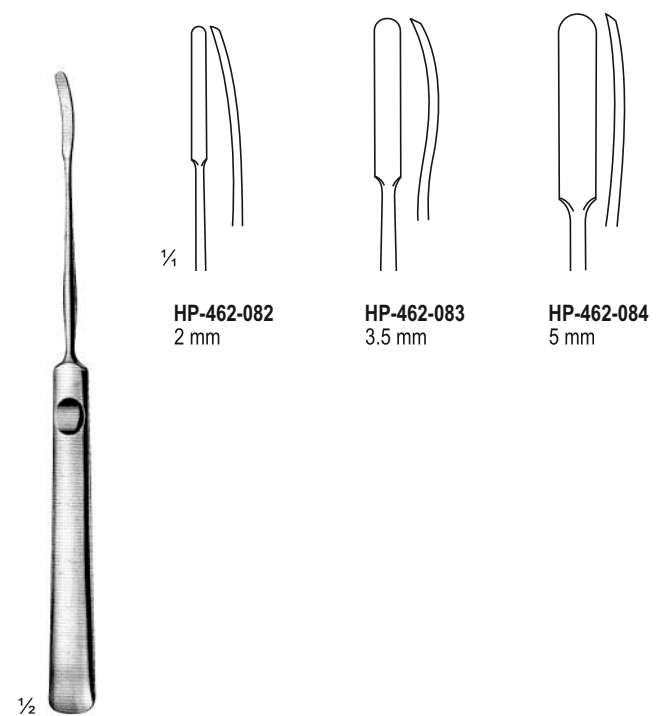

1/2

Marchac
HP-462-082 - HP-462-084
17 cm
Periosteal elevator



Marchac
HP-463-085
 19 cm
 Suction Dissector

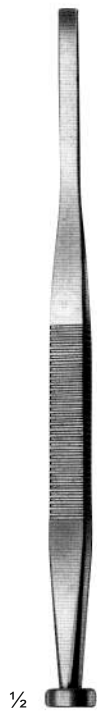

Marchac
HP-463-086 - HP-463-088
 18.5 cm
 Osteotome



HP-463-086
 4 mm



HP-463-087
 6 mm



HP-463-088
 8 mm

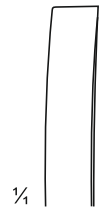

HP-463-089
 8 mm



Marchac
HP-463-090
 20 cm
 Bone hook

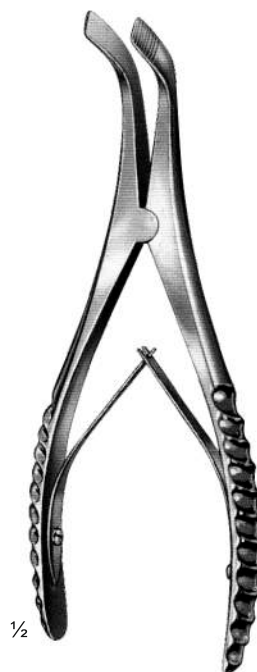

Marchac
HP-463-091
 17.5 cm
 Bone expander

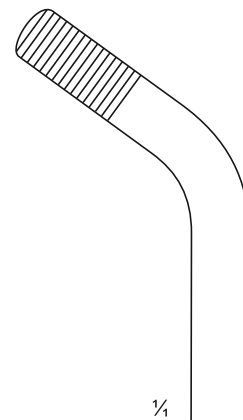



Holloware

Holloware
Holloware
Holloware

Page 465-477

Instruments Trays, Accessories for Burs

Instrumente Trays, Zubehör für Burs
Bandejas de instrumentos, acessórios para brocas
Bandejas de Instrumentos, Accesorios para Burs

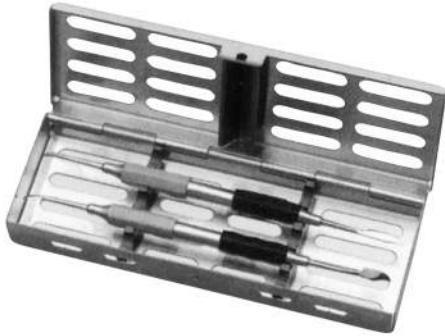

Chico
Stainless Steel for 5 instruments
HP-465-001 180 x 60 x 22 mm



Medio
Stainless Steel for 10 instruments
HP-465-002 180 x 125 x 22 mm



Maxi
Stainless Steel for 20 instruments
HP-465-003 280 x 180 x 25 mm



Maxi Set 1
Stainless Steel rack for 15 instruments
HP-465-004 288 x 187 x 40 mm



Maxi Set 2
Stainless Steel for 15 instruments
HP-465-005 288 x 187 x 40 mm



Maxi Set 3
Stainless Steel for 15 instruments
HP-465-006 288 x 187 x 40 mm

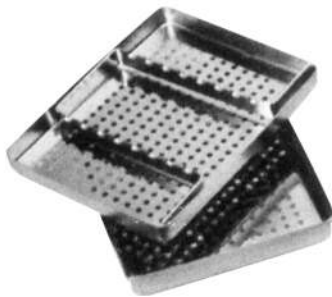

Medio
Stainless Steel Perforated Tray with cover
HP-465-007 187 x 145 x 25 mm

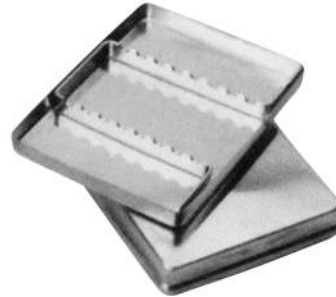

Medio
Stainless Steel Solid Tray with cover
HP-465-008 187 x 145 x 25 mm



Burs Disinfecting Box Stainless Steel
HP-465-009 90 mm x 40 mm



Mesh Burs Holder
HP-465-010 35 mm x 150 mm

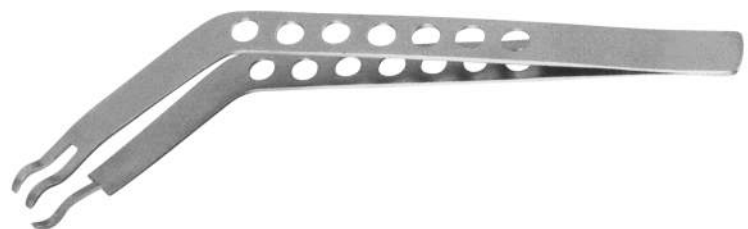

HP-465-011 Bur Holding Tweezer 16.5 cm

Perforated Box, Kidney Trays, Endodontic Trays, Lester Pumice Cup
 Perforierte Box, Nierenschalen, Endodontische Schalen, Lester Bimsstein Cup
 Caixa Perfurada, Bandejas Renais, Bandejas Endodónticas, Lester Pumice Cup
 Caja perforada, bandejas de riñón, bandejas de endodoncia, taza de pómez Lester



Perforated Instruments Boxes	
HP-466-012	170 x 070 x 35 mm
HP-466-013	180 x 080 x 40 mm
HP-466-014	200 x 100 x 40 mm
HP-466-015	200 x 100 x 50 mm
HP-466-016	200 x 100 x 60 mm
HP-466-017	220 x 120 x 60 mm
HP-466-018	250 x 120 x 60 mm
HP-466-019	300 x 150 x 60 mm
HP-466-020	300 x 200 x 80 mm
HP-466-021	400 x 160 x 80 mm
HP-466-022	400 x 200 x 100 mm
HP-466-023	500 x 200 x 120 mm

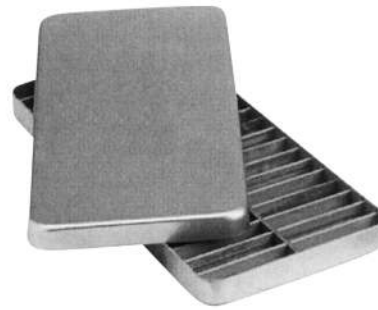

Stainless Steel endodontic tray with cover	
HP-466-024	250 x 115 x 15 mm

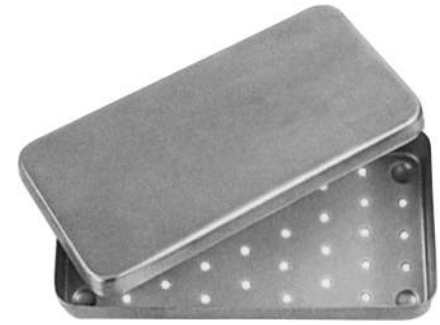

Instrument Box perforated	
HP-466-025	180 x 90 x 30 mm

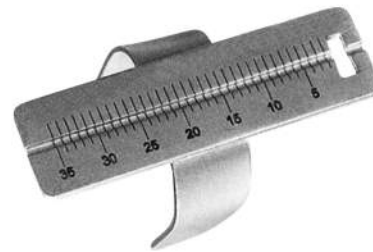

HP-466-026	Endometer Laser etched
------------	------------------------



Lester Pumice Cup	
HP-466-027	30 mm



Kidney Trays With LID	
	dia.
HP-466-028	150 mm
HP-466-029	200 mm
HP-466-030	250 mm
HP-466-031	300 mm



Kidney Trays	
	dia.
HP-466-032	130 mm
HP-466-033	150 mm
HP-466-034	180 mm
HP-466-035	200 mm
HP-466-036	230 mm
HP-466-037	250 mm
HP-466-038	280 mm
HP-466-039	300 mm
HP-466-040	350 mm



Kidney Trays Shallow	
	dia.
HP-466-041	150 mm
HP-466-042	200 mm
HP-466-043	250 mm
HP-466-044	300 mm
HP-466-045	350 mm

Endodontic Boxes, Instruments

Endodontie-Boxen, Instrumente
Caixas Endodônticas, Instrumentos
Cajas de endodoncia, instrumentos

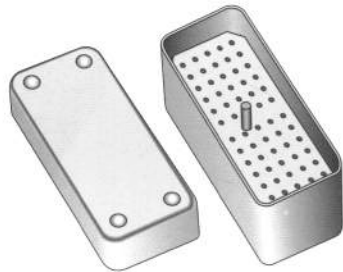

Dimensions
HP-467-046 104 x 44 x 54 mm



Lid-Dimensions
HP-467-047 204 x 105 x 54 mm



Lid-Dimensions
HP-467-048 204 x 105 x 54 mm

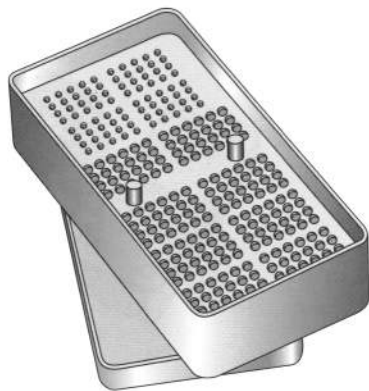

Lid-Dimensions
HP-467-049 204 x 105 x 54 mm



Lid-Dimensions
HP-467-050 125 x 105 x 54 mm

Cotton Dispensers Stainless Steel



HP-467-051
Round Aluminium Endodontic Boxes, Complete With Lid
Dimensions = 94 mm
Height = 70 mm



HP-467-052



HP-467-053

Spirit Lamps, Forceps Jars, Dressing Jars
 Spiritus Lampen, Pinzetten Gläser, Dressing Gläser
 Lâmpadas De Espíritos, Frascos De Fôrceps, Jarros De Vestir
 Lámparas de alcohol, frascos de fôrceps, frascos de apósito



HP-468-054 Spirit Lamp 120 cc



HP-468-055 Spirit Lamp 120 cc



HP-468-056 Spirit Lamp 120 cc

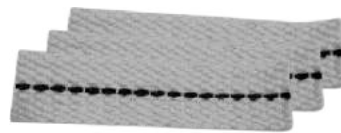

HP-468-057 Spare wicks Flat 13 cm (pack of 5)

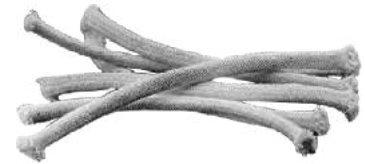

HP-468-058 Spare wicks Round 13c m (pack of 5)



Forceps Jars

	dia.	height
HP-468-059	30	90 mm
HP-468-060	50	100 mm
HP-468-061	50	130 mm
HP-468-062	50	175 mm
HP-468-063	75	100 mm
HP-468-064	75	130 mm
HP-468-065	75	175 mm
HP-468-066	100	175 mm
HP-468-067	100	200 mm



Dressing Jars With Lid & Knob

	dia.	height
HP-468-068	75 mm	60 mm
HP-468-069	75 mm	75 mm
HP-468-070	100 mm	60 mm
HP-468-071	100 mm	100 mm
HP-468-072	125 mm	80 mm
HP-468-073	125 mm	125 mm
HP-468-074	150 mm	150 mm



Dressing Jars / Cotton Containers

	80 x 60 mm
HP-468-075	80 x 80 mm
HP-468-076	100 x 60 mm
HP-468-077	100 x 80 mm
HP-468-078	100 x 100 mm
HP-468-079	120 x 80 mm
HP-468-080	120 x 100 mm
HP-468-081	120 x 120 mm
HP-468-082	150 x 100 mm
HP-468-083	150 x 150 mm
HP-468-084	180 x 150 mm
HP-468-085	180 x 180 mm
HP-468-086	200 x 200 mm
HP-468-087	240 x 240 mm

Bowls, Gallipots, Wash Basins, Medicine Cups

Schüsseln, Gallipots, Waschbecken, Medizinbecher
Tigelas, Gallipots, lavatórios, copos de medicina
Cuencos, Gallipots, lavabos, tazas de medicinas



Gallipot		
	oz.	ml.
HP-469-088	2 oz	60 ml
HP-469-089	3 oz	90 ml
HP-469-090	4 oz	120 ml
HP-469-091	6 oz	180 ml
HP-469-092	8 oz	240 ml
HP-469-093	10 oz	300 ml
HP-469-094	12 oz	360 ml
HP-469-095	16 oz	480 ml
HP-469-096	18 oz	540 ml
HP-469-097	22 oz	660 ml
HP-469-098	28 oz	840 ml
HP-469-099	36 oz	1080 ml



Stainless Steel Round Bowls / Lotion Bowls			
	dia.	height	vol.
HP-469-100	Ø 40 mm	x 19 mm	0.05L
HP-469-101	Ø 60 mm	x 30 mm	0.07L
HP-469-102	Ø 80 mm	x 40 mm	0.14L
HP-469-103	Ø 100 mm	x 50 mm	0.35L
HP-469-104	Ø 120 mm	x 60 mm	0.45L
HP-469-105	Ø 150 mm	x 70 mm	0.70L
HP-469-106	Ø 180 mm	x 90 mm	1.10L
HP-469-107	Ø 200 mm	x 100 mm	1.60L



Stainless Steel Bowls			
	dia.	height	vol.
HP-469-108	Ø 40 mm	x 19 mm	0.05L
HP-469-109	Ø 60 mm	x 30 mm	0.07L
HP-469-110	Ø 80 mm	x 40 mm	0.14L
HP-469-111	Ø 100 mm	x 50 mm	0.35L
HP-469-112	Ø 120 mm	x 60 mm	0.45L
HP-469-113	Ø 150 mm	x 70 mm	0.70L
HP-469-114	Ø 180 mm	x 90 mm	1.10L
HP-469-115	Ø 200 mm	x 100 mm	1.60L



Wash Basins	
	dia.
HP-469-116	300 mm
HP-469-117	320 mm
HP-469-118	350 mm
HP-469-119	400 mm
HP-469-120	450 mm



Medicine Cup		
	dia.	height
HP-469-121	80 x	35 mm
HP-469-122	125 x	60 mm
HP-469-123	160 x	60 mm
HP-469-124	180 x	70 mm
HP-469-125	200 x	70 mm
HP-469-126	300 x	120 mm



Medicine Cup (Graduated)	
Size (mm)	Cap.(ml)
HP-469-127	2 Oz. 60 ml



Scalers Trays	
HP-470-128	190 x 100 x 17 mm
HP-470-129	200 x 100 x 25 mm

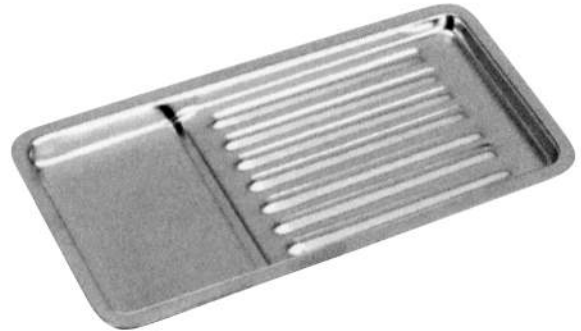

Scalers Trays	
HP-470-130	185 x 80 x 15 mm



Instruments Trays With LID	
HP-470-131	150 x 100 x 50 mm
HP-470-132	200 x 100 x 50 mm
HP-470-133	220 x 120 x 50 mm
HP-470-134	240 x 140 x 50 mm
HP-470-135	200 x 150 x 50 mm
HP-470-136	250 x 200 x 50 mm
HP-470-137	300 x 250 x 50 mm
HP-470-138	300 x 200 x 50 mm
HP-470-139	350 x 250 x 50 mm
HP-470-140	400 x 300 x 50 mm
HP-470-141	450 x 300 x 50 mm
HP-470-142	450 x 350 x 50 mm



Instruments Trays Without LID	
HP-470-143	150 x 100 x 50 mm
HP-470-144	200 x 100 x 50 mm
HP-470-145	220 x 120 x 50 mm
HP-470-146	240 x 140 x 50 mm
HP-470-147	200 x 150 x 50 mm
HP-470-148	250 x 200 x 50 mm
HP-470-149	300 x 250 x 50 mm
HP-470-150	300 x 200 x 50 mm
HP-470-151	350 x 250 x 50 mm
HP-470-152	400 x 300 x 50 mm
HP-470-153	450 x 300 x 50 mm
HP-470-154	450 x 350 x 50 mm

Instruments Trays, Accessories for Burs

Instrumente Trays, Zubehör für Burs
Bandejas de instrumentos, acessórios para brocas
Bandejas de Instrumentos, Accesorios para Burs



Flat Instruments Trays / Mayo Trays	
HP-471-155	210 x 160 x 10 mm
HP-471-156	240 x 180 x 10 mm
HP-471-157	310 x 150 x 10 mm
HP-471-158	310 x 210 x 10 mm
HP-471-159	350 x 240 x 10 mm
HP-471-160	400 x 300 x 10 mm
HP-471-161	450 x 300 x 10 mm

Mayo Trays Perforated	
HP-471-162	210 x 160 x 10 mm
HP-471-163	240 x 180 x 10 mm
HP-471-164	310 x 150 x 10 mm
HP-471-165	310 x 210 x 10 mm
HP-471-166	350 x 240 x 10 mm
HP-471-167	400 x 300 x 10 mm
HP-471-168	450 x 300 x 10 mm



DIN Baskets perforated sides	
HP-471-169	240 x 240 x 50 mm
HP-471-170	240 x 240 x 100 mm
HP-471-171	480 x 260 x 50 mm
HP-471-172	520 x 260 x 80 mm
HP-471-173	520 x 260 x 100 mm

Wiremesh Baskets perforated	
HP-471-174	240 x 240 x 50 mm
HP-471-175	260 x 240 x 100 mm
HP-471-176	480 x 260 x 50 mm
HP-471-177	520 x 260 x 80 mm
HP-471-178	520 x 260 x 100 mm

Instruments Boxes, Electric / Non-Electric Sterilizers

Instrumentenboxen, elektrische / nichtelektrische Sterilisatoren
 Caixas de instrumentos, esterilizadores elétricos / não elétricos
 Cajas de instrumentos, esterilizadores eléctricos / no eléctricos



Instrument Boxes With Side Handle	
HP-472-179	150 x 100 x 50 mm
HP-472-180	200 x 100 x 50 mm
HP-472-181	220 x 120 x 50 mm
HP-472-182	240 x 140 x 50 mm
HP-472-183	200 x 150 x 50 mm
HP-472-184	250 x 200 x 50 mm
HP-472-185	300 x 200 x 50 mm
HP-472-186	300 x 250 x 50 mm
HP-472-187	400 x 300 x 50 mm
HP-472-188	450 x 300 x 50 mm
HP-472-189	450 x 350 x 50 mm

Instrument Boxes With LID	
HP-472-190	150 x 100 x 50 mm
HP-472-191	200 x 100 x 50 mm
HP-472-192	220 x 120 x 50 mm
HP-472-193	240 x 140 x 50 mm
HP-472-194	200 x 150 x 50 mm
HP-472-195	250 x 200 x 50 mm
HP-472-196	300 x 200 x 50 mm
HP-472-197	300 x 250 x 50 mm
HP-472-198	400 x 300 x 50 mm
HP-472-199	450 x 350 x 50 mm
HP-472-200	500 x 200 x 70 mm



Non-Electric Sterilizer	
HP-472-201	170 x 070 x 35 mm
HP-472-202	180 x 080 x 40 mm
HP-472-203	200 x 100 x 40 mm
HP-472-204	200 x 100 x 50 mm
HP-472-205	200 x 100 x 60 mm
HP-472-206	220 x 120 x 60 mm
HP-472-207	250 x 120 x 60 mm
HP-472-208	300 x 150 x 60 mm
HP-472-209	300 x 200 x 80 mm
HP-472-210	400 x 160 x 80 mm
HP-472-211	400 x 200 x 100 mm
HP-472-212	500 x 200 x 120 mm

Electric Sterilizer	
HP-472-213	170 x 070 x 35 mm
HP-472-214	180 x 080 x 40 mm
HP-472-215	200 x 100 x 40 mm
HP-472-216	200 x 100 x 50 mm
HP-472-217	200 x 100 x 60 mm
HP-472-218	220 x 120 x 60 mm
HP-472-219	250 x 120 x 60 mm
HP-472-220	300 x 150 x 60 mm
HP-472-221	300 x 200 x 80 mm
HP-472-222	400 x 160 x 80 mm
HP-472-223	400 x 200 x 100 mm
HP-472-224	500 x 200 x 120 mm

Instruments Boxes, Catheter Trays, Thermometer Jars, Sterilizing Forceps
 Instrumentenboxen, Katheterschalen, Thermometergläser, Sterilisationszangen
 Caixas de instrumentos, bandejas de cateter, frascos de termômetro, fórceps de esterilização
 Cajas de Instrumentos, Bandejas de Catéter, Frascos de Termómetro, Pinzas de Esterilización



Instruments Boxes Perforated	
HP-473-225	180 x 80 x 30 mm
HP-473-226	180 x 80 x 40 mm
HP-473-227	180 x 80 x 50 mm
HP-473-228	200 x 100 x 30 mm
HP-473-229	200 x 100 x 40 mm
HP-473-230	200 x 100 x 50 mm
HP-473-231	250 x 120 x 40 mm
HP-473-232	250 x 120 x 50 mm
HP-473-233	250 x 120 x 60 mm



Catheter trays with cover	
HP-473-234	200 x 60 x 40 mm
HP-473-235	200 x 90 x 40 mm
HP-473-236	320 x 95 x 50 mm
HP-473-237	365 x 90 x 50 mm
HP-473-238	440 x 115 x 50 mm



Instruments Boxes With Filters	
HP-473-239	170 x 070 x 35 mm
HP-473-240	180 x 080 x 40 mm
HP-473-241	200 x 100 x 40 mm
HP-473-242	200 x 100 x 50 mm
HP-473-243	200 x 100 x 60 mm
HP-473-244	220 x 120 x 60 mm
HP-473-245	250 x 120 x 60 mm
HP-473-246	300 x 150 x 60 mm
HP-473-247	300 x 200 x 80 mm
HP-473-248	400 x 160 x 80 mm
HP-473-249	400 x 200 x 100 mm
HP-473-250	500 x 200 x 120 mm



Thermometer Jar	
	dia. height
HP-473-251	Ø 25 x 100 mm

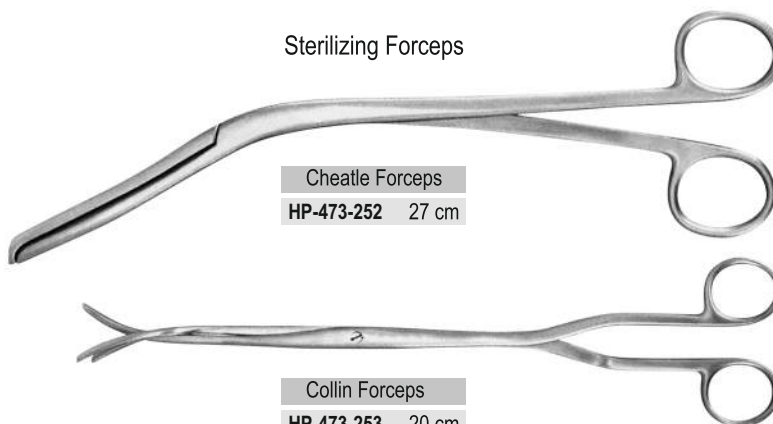

Sterilizing Forceps

Cheatle Forceps
HP-473-252 27 cm

Collin Forceps
HP-473-253 20 cm



Needle Case	
HP-474-254	210 x 125 x 17 mm



Needle Case Sauerbruch	
HP-474-255	210 x 125 x 17 mm



Needle Case	
HP-474-256	150 x 90 x 10 mm



Needle Cases Perforated	
HP-474-257	50 x 25 x 4.5 mm
HP-474-258	65 x 42 x 8 mm
HP-474-259	75 x 25 x 4.5 mm



Needle Cases Plain	
HP-474-260	50 x 25 x 4.5 mm
HP-474-261	65 x 42 x 8 mm
HP-474-262	75 x 25 x 4.5 mm



HP-474-263	Needle Case Complete
------------	----------------------



Funnels	
	dia.
HP-474-264	100 mm
HP-474-265	120 mm
HP-474-266	150 mm
HP-474-267	200 mm
HP-474-268	240 mm



Petri Dishes	
	Dia. x Height
HP-474-269	60 x 20 mm
HP-474-270	90 x 15 mm
HP-474-271	100 x 20 mm
HP-474-272	120 x 20 mm

Urinals, Bedpans
Urinale, Bettpfannen
Urinóis, Lençóis
Orinales, cuñas



Urinal Jugs

HP-475-273	Horizontal	115 x 230 mm
HP-475-274	Vertical Junior	95 x 205 mm
HP-475-275	Vertical Adult	100 x 225 mm



HP-475-276

Male Urinal



HP-475-277

Urinal Female

1200 ml



Bedpan

	dia.
HP-475-278	235 mm
HP-475-279	320 mm



Bedpan

	dia.
HP-475-280	235 mm
HP-475-281	320 mm



Bedpan

HP-475-282	300 x 235 x 72 mm
HP-475-283	400 x 255 x 90 mm



HP-475-284

Bedpan Simple



Compartmental Tray
HP-476-285 390 x 290 x 20 mm



Sterilizing Drums	
	Dia. x Height
HP-476-290	Ø 80 x 80 mm
HP-476-291	Ø 105 x 120 mm
HP-476-292	Ø 140 x 140 mm
HP-476-293	Ø 160 x 120 mm
HP-476-294	Ø 160 x 150 mm
HP-476-295	Ø 190 x 150 mm
HP-476-296	Ø 190 x 190 mm
HP-476-297	Ø 240 x 160 mm
HP-476-298	Ø 240 x 240 mm
HP-476-299	Ø 290 x 160 mm
HP-476-300	Ø 290 x 240 mm
HP-476-301	Ø 340 x 160 mm
HP-476-302	Ø 340 x 340 mm
HP-476-303	Ø 390 x 190 mm
HP-476-304	Ø 380 x 290 mm



American Pattern Bed Pan Adult
HP-476-286 355 x 290 x 110 x 55 mm
HP-476-287 308 x 80 x 80 x 45 mm

American Pattern Bed Pan Adult With Lid
HP-476-288 355 x 290 x 110 x 55 mm
HP-476-289 308 x 80 x 80 x 45 mm



Dissecting Kits

Kits zerlegen

Kits de Dissecação

Kits de disección

Page 478-480

Dissecting Kits

Kits zerlegen
Kits de Dissecação
Kits de disección



Dissecting Kit - Set of 9 Pcs
HP-478-001

- Probe 14 cm
- Scalpel Handle 15 cm
- Scalpel Handle 15 cm
- Butterfly probe
- Dressing Forcep 13 cm
- Kocher Forcep 13 cm
- Dressing Scissor S/B Str 13 cm
- Dressing Scissor S/B Cvd 13 cm
- Needle Holder Forcep 13 cm

Dissecting Kit - Set of 9 Pcs
HP-478-002

- Butterfly probe
- Probe 14 cm
- Needle Holder Forcep 14 cm
- Scalpel Handle # 3
- Scalpel Handle # 4
- Dressing Scissor S/B Str 14 cm
- Dressing Scissor S/B Cvd 14 cm
- Dressing Forcep 14 cm
- Kocher Forcep 1x2 Teeth 14 cm



Dissecting Kit - Set of 13 Pcs
HP-478-003

- Frazier Hook 15 cm
- Scalpel Handle 15 cm
- Scalpel Handle 15 cm
- Scalpel Handle # 3 (Scalling Engraved)
- Dressing Forcep 13 cm
- Butterfly Probe
- Probe Scissor Str 14 cm
- Probe 14 cm
- Scalpel Blade # 10 (5 Pcs)





Dissecting Kit - Set of 13 Pcs
HP-479-004

- Chain Hook 3
- Needle Holder Forcep 14 cm
- Kelly Forcep Str 14 cm
- Kelly Forcep Cvd 14 cm
- Scalpel Handle # 3
- Farabeuf Retractor
- Dressing Scissor S/B Str 14 cm
- Dressing Scissor S/B Cvd 14 cm
- Mosquito Forcep 14 cm
- Kocher Forcep 14 cm
- Dressing Forcep 14 cm
- Eye Probe
- Butterfly probe

Dissecting Kit - Set of 19 Pcs
HP-479-005

- Operating Scissor S/B Str 14 cm
- Operating Scissor S/B Cvd 14 cm
- Mosquito Forcep Str 13 cm
- Kelly Forcep Str 14 cm
- Kelly Forcep Cvd 14 cm
- Mayo Hegar Needle Holder 14 cm
- Butterfly probe
- Kocher Forcep 14 cm
- Dressing Forcep 14 cm
- Scalpel Handle # 3
- Scalpel Handle # 4
- Needle Straight (Plastic Handle)
- Needle Curved (Plastic Handle)
- Farabeuf Retractor
- Probe With Hole 14 cm
- Needle With Thread
- Surgical Sterile Blade # 3
- Surgical Sterile Blade # 4
- Chain Hook



Dissecting Kit - Set of 20 Pcs
HP-479-006

- Scalpel Handle # 3
- Simken Forcep Str 12 cm
- Simken Forcep Cvd 12 cm
- Simken Kocher Forcep Str 10 cm
- Mosquito Forcep Cvd 12 cm
- Plastic Handle Probe Str 13 cm
- Plastic Handle Probe Cvd 13 cm
- Dressing Scissor S/B Str 14 cm
- Iris Scissor Str 12 cm
- Frazier Hook 15 cm
- Surgical Sterile Blade # 10 (10 Pcs)

Dissecting Kits

Kits zerlegen
Kits de Dissecação
Kits de disección



Dissecting Kit - Set of 35 Pcs
HP-480-007

- Probe
- Butterfly Probe
- Dressing Forcep 14 cm
- Kocher Forcep 1x2 Teeth 14 cm
- Micro Forcep 12.5 cm
- Surgical Sterile Blade # 3
- Surgical Sterile Blade # 4
- Scalpel Knife 15 cm
- Dissecting Spatula
- Mosquito Forcep Cvd 12.5 cm
- Iris Scissor Str 11.5 cm
- Magnifying Glass (Plastic Handle)
- Operating Scissor S/B Str 14 cm
- Needle Curved Point 14.5 cm
- Needle Straight Point 14.5 cm
- Surgical Sterile Blade # 22 (10 Pcs)
- Surgical Sterile Blade # 10 (10 Pcs)

- Iris Scissor Str 11.5 cm
- Operating Scissor S/S Str 14 cm
- Operating Scissor S/B Str 14 cm
- Operating Scissor B/B Str 14 cm
- Surgical Sterile Blade # 3
- Surgical Sterile Blade # 4
- Needle Straight Point 14 cm
- Needle Curved Point 14 cm
- Probe
- Probe With Hole 14 cm
- Butterfly Probe
- Frazier Hook 17 cm
- Dressing Forcep 14 cm
- Kocher Forcep 14 cm
- Micro Forcep 12.5 cm
- Simken Forceps 10 cm
- Simken Forceps 10 cm Cvd Serrated
- Simken Forceps 10 cm Cvd Serrated
- Kelly Forcep Str 14 cm
- Kelly Forcep Cvd 14 cm
- Mosquito Forcep Str 12.5 cm
- Mosquito Forcep Cvd 12.5 cm
- Surgical Sterile Blade # 22 (10 Pcs)
- Surgical Sterile Blade # 10 (10 Pcs)



Dissecting Kit - Set of 42 Pcs
HP-480-008

Dissecting Kit - Set of 53 Pcs
HP-480-009

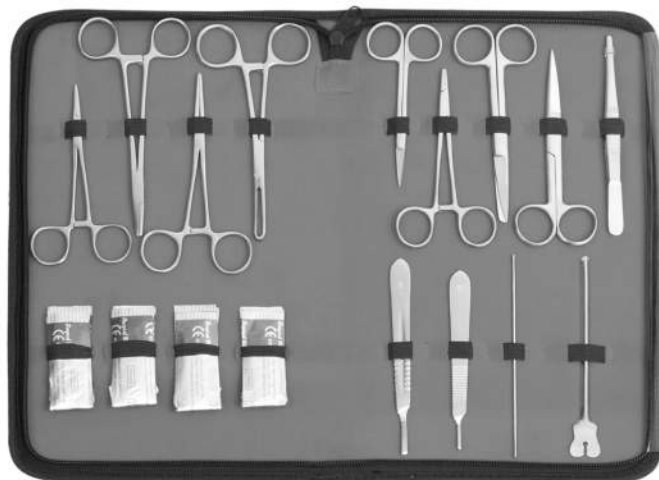

- Operating Scissor S/B Str 14 cm
- Mayo Scissor Str 14 cm
- Kelly Forcep Str 14 cm
- Allis Tissue Forcep 1x2 Teeth 14 cm
- Dressing Forcep 14 cm
- Mosquito Forcep Str 12.5 cm
- Webster Needle Holder 12.5 cm
- Mayo Hegar Needle Holder 15 cm
- Iris Scissor Str 11.5 cm
- Surgical Sterile Blade # 3
- Surgical Sterile Blade # 4
- Double Ended Probe 14 cm
- Butterfly Probe
- Surgical Sterile Blade # 22 (10 Pcs)
- Surgical Sterile Blade # 10 (10 Pcs)
- Surgical Sterile Blade # 11 (10 Pcs)
- Surgical Sterile Blade # 15 (10 Pcs)



SURGICAL Instruments Catalogue



 MuradPur New Abadi, Near Police Station, Sialkot - 51310 Pakistan

 +92 (326) 877 8787

 info@healproinstruments.com | healprohealthproduct@gmail.com

 www.healproinstruments.com

