



Orthopedic Instruments Catalogue

- Basic Orthopedic Instruments
- Spinal Instruments
- Trauma Instruments



INDEX

<u>PARTICULARS</u>	<u>PAGE</u>
1) ORTHOPEDIC DRESSING – PLASTER INSTRUMENTS	03-05
2) AMPUTATION SAW – GIGLI SAW	06-07
3) REAMERS – AWLS – BONE HOOKS	08-09
4) ORTHOPEDIC HAND BONE DRILLS & ACCESSORIES	10-03
5) BONE HOLDING CLAMPS – TRACTION BARS	14-15
6) VISE GRIPS – NOSE PLIERS – SLAP HAMMERS	16-17
7) NOSE PLIERS – PULLING FORCEPS – WIRE CUTTERS	18-20
8) PLIERS – BENDERS – ROD INSTRUMENTS	21-22
9) WIRE INSTRUMENTS – EXTENSION BOWS	23-25
10) RING CUTTERS – LEAD HANDS – BIPOSY TOOLS	26-27
11) BONE TEMPERS – IMPACTORS - PACKERS	28
12) BONE RASPS – FILES	29-32
13) BONE LEVERS – RETRACTORS	33-39
14) CHISELS – OSTEOTOMES – GOUGES	40-45
15) BONE CURETTES	46-51
16) PERIOSTEAL ELEVATORS – DISSECTORS	52-56
17) ORTHOPEDIC MALLETS & ELEVATORS SPINAL S/S & SPINAL	58-60
18) TENDON INSTRUMENTS	61-64
19) PELVIC REDUCTION FORCEPS	65-66
20) BONE HOLDING FORCEPS	67-74
21) REPOSITION – CARTILAGE FORCEPS	75
22) BONE CUTTING FORCEPS	76-79
23) BONE RONGEURS – NIBBLERS	80-90
24) RIB SHEARS	91-92
25) LAMINA SPREADERS – RETRACTORS	93-94
26) CALCANEAL LAMBARDI SPREADERS	95
27) COMPRESSORS - DISTRACTORS	96-97
28) ROD BENDERS	98
29) CARBIDE WIRE – PIN CUTTING PLIERS	99-102
30) CARBIDE INSERTED SURGICAL SCISSORS	103-104
31) INSTRUMENTS FOR TRUATOMY	105-117

ORTHOPEDIC DRESSING – PLASTER INSTRUMENTS

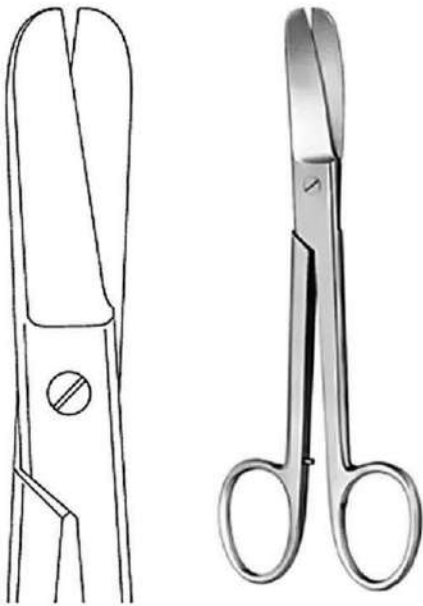

HP-11-01-0300
Lorenz Bandage Scissors
Heavy Pattern 23 cm / 9"

Also available
in 18.5 cm / 7 1/4"
& 20 cm / 8"

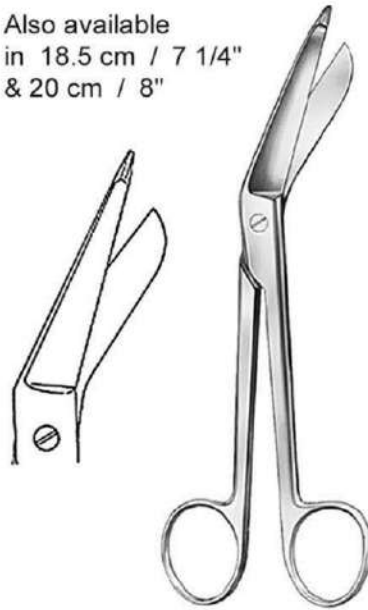

HP-11-01-0301
Lister Bandage Scissors
14.5 cm / 5 3/4"

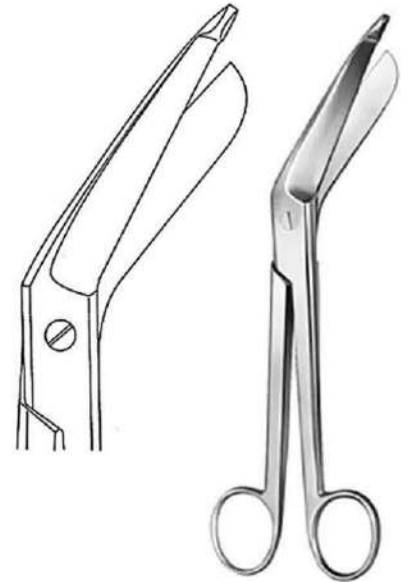

HP-11-01-0302
Bergmann Plaster Shears
Heavy Pattern 23.5 cm / 9"



HP-11-01-0303
Esmarch Plaster Shears
Heavy Pattern, Short Blades
20 cm / 8"



Also available
in 18cm / 7 1/2"

HP-11-01-0304
Bandage Scissors
16cm / 6 1/4" Black Plastic Rings

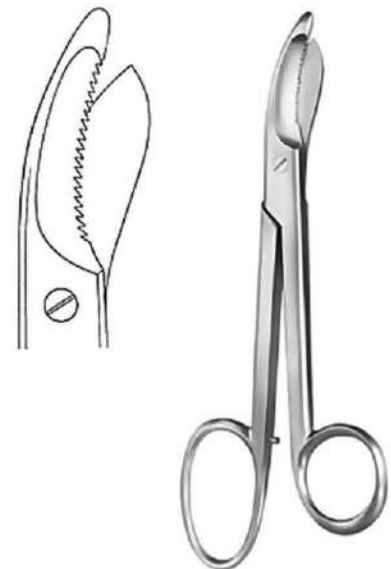

HP-11-01-0305
Bruns Plaster Scissors 24 cm
9 1/2" One Serrated Cutting Edge

ORTHOPEDIC DRESSING – PLASTER INSTRUMENTS



Also Available
26 cm / 10"
38 cm / 15"

HP-11-01-0306

Stille-Martin Plaster Shears
23 cm / 9"



HP-11-01-0307

Engel Plaster Saw 15.5 cm / 6"



HP-11-01-0308

Engel Plaster Saw 15.5 cm / 6"



HP-11-01-0308

Bergmann Plaster Saw 18 cm / 7"



HP-11-01-0309 Reiner Plaster Knife 18 cm / 7"



HP-11-01-0311 Hopkins Plaster Knife 20 cm / 8"



HP-11-01-0310 Esmarch Plaster Knife 18 cm / 7"



with wooden handle

HP-11-01-0312 Martin Plaster Knife 21 cm / 8 ¼"

ORTHOPEDIC DRESSING – PLASTER INSTRUMENTS

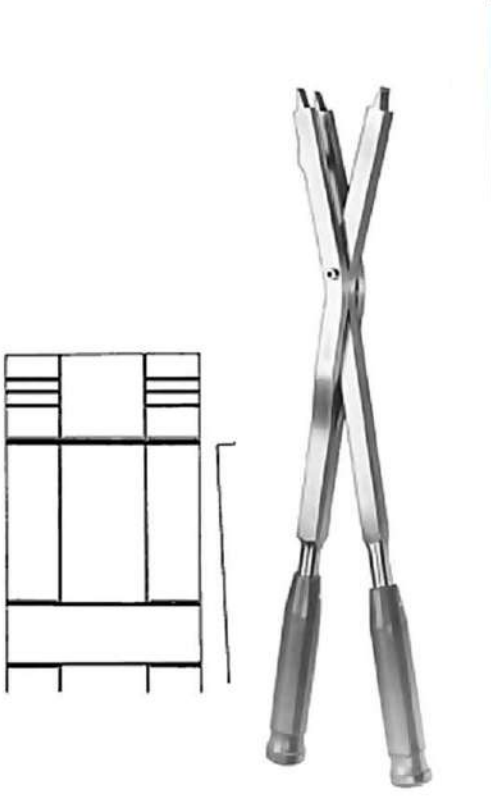

HP-11-01-0313

Hermann Plaster Spreader
48 cm / 19" Heavy Pattern



HP-11-01-0314

Hennig Plaster Spreader
28 cm / 11"



HP-11-01-0315

Hennig Plaster Spreader
30 cm / 12"



HP-11-01-0316 Beeson Plaster Spreader 1.5 in Blade 30 cm / 12"

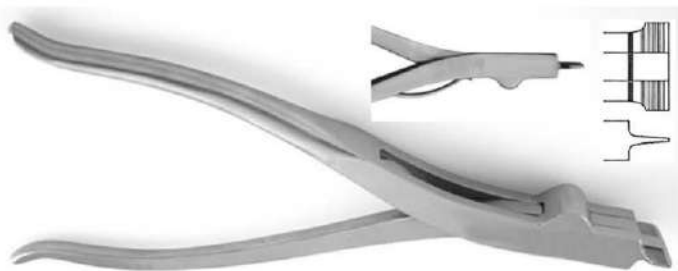

HP-11-01-0317 Walton Plaster Spreader w/Spring 3 Prongs 23 cm / 9"

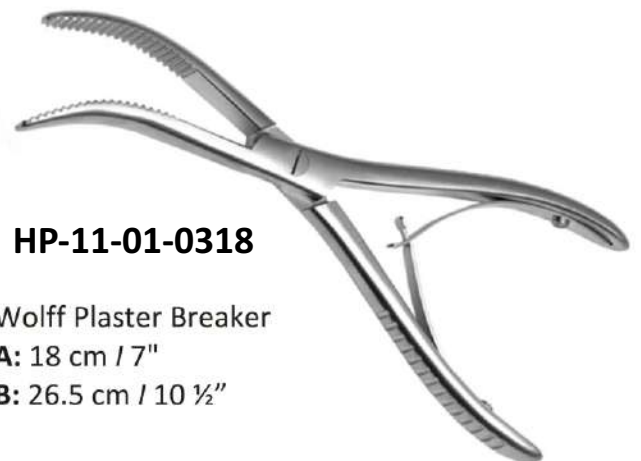

HP-11-01-0318

Wolff Plaster Breaker
A: 18 cm / 7"
B: 26.5 cm / 10 ½"

AMPUTATION SAW – GIGLI SAW

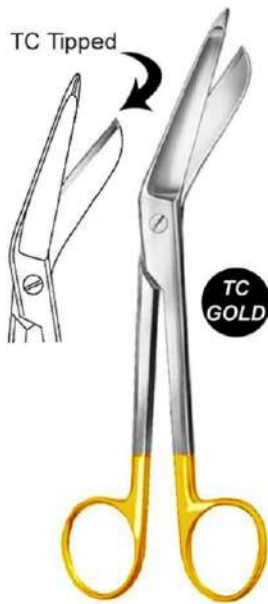

HP-11-01-0319

Lister Bandage Scissors TC
18 cm / 7" cm / 13 3/4"



HP-11-01-0320

Bruns Plaster Scissors
24 cm / 9 1/2"



HP-11-01-0321

Charriere Amputation Saw 35 cm / 13 3/4"



A: 21.5 cm / 8 3/4" 12mm



B: 21.5 cm / 8 3/4" 15mm



C: 21.5 cm / 8 3/4" 18mm

Spare Saw Blades



HP-11-01-0322

BIER Amputation Saw 40.5 cm / 16"



A: 27 cm / 10 3/4" 4 mm wide



B: 27 cm / 10 3/4" 6 mm wide



C: 27 cm / 10 3/4" 8 mm wide



HP-11-01-0323

Langenbeck Amputation Saw 24.5 cm / 9 3/4"



HP-11-01-0324 Satterlee Amputation Saw
29 cm / 11 1/2"



HP-11-01-0325 Charriere Amputation Saw 27 cm / 10 1/2"



HP-11-01-0326 Satterlee Amputation Saw 23 cm / 9"

AMPUTATION SAW – GIGLI SAW

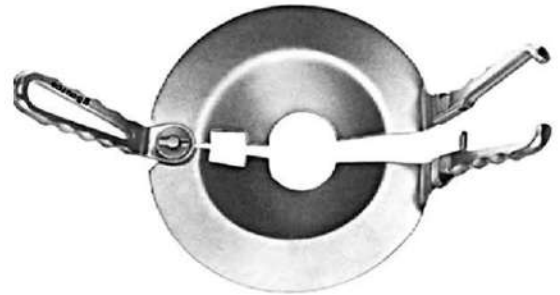
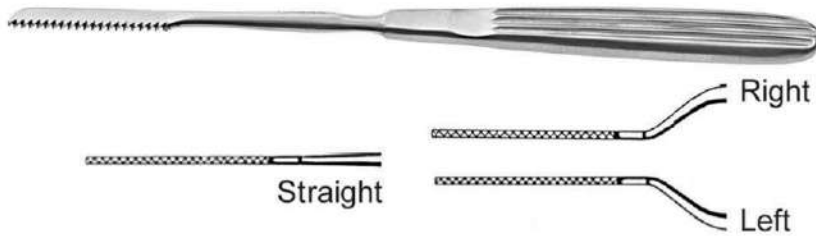

HP-11-01-0327 Joseph Amputation Saw 18 cm / 7"

HP-11-01-0328

Percy Amputation Shield 30 cm / 12"



HP-11-01-000

- A:** Gigli Saw 30cm
- B:** Gigli Saw 50cm
- C:** Tyler Gigli Saw (Large Cut) 30cm
- D:** Tyler Gigli Saw (Large Cut) 30cm

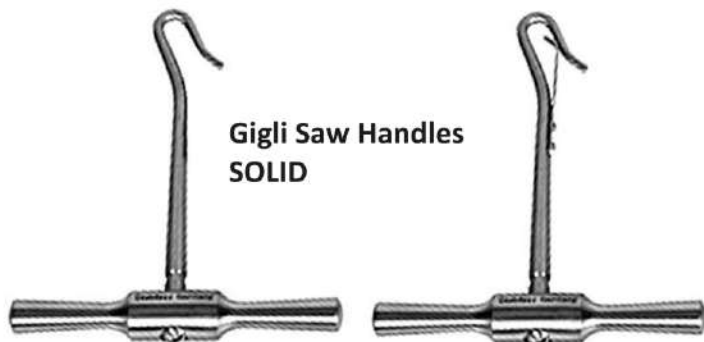

**Gigli Saw Handles
SOLID**

HP-11-01-001 Gigli Sold in Pair

HP-11-01-002 Gigli Sold in Pair



HP-11-01-005 BAILEY GIGLI SAW GUIDE 30 CM

HP-11-01-006 POPPEN GIGLI SAW GUIDE 28 CM



**Gigli Saw Handles
SOLID**

HP-11-01-003 Gigli Sold in Pair

HP-11-01-004 Gigli Sold in Pair



REAMERS - AWLS - BONE HOOKS



HP-11-01-0329

Reamer
13.5cm / 5 1/4"



HP-11-01-0330

Perthes Reamer
18 cm / 7"



HP-11-01-0331

Perthes Reamer
21.5 cm / 8 1/2"



HP-11-01-0332

Reamer One concave
side 14 cm / 5 1/2"



HP-11-01-0333

Glenoid Punch
20 cm / 8"

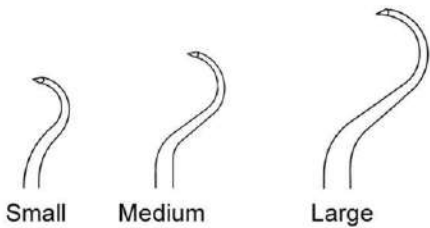

HP-11-01-0334

Shoulder Percussion Awl **A:** 21.5cm / 8 1/2" **B:** 23.5cm / 9 1/4"



A: 20cm / 8"
19X27mm
Sharp

B: 23cm / 9"
15X20mm
Blunt

C: 23cm / 9"
15X20mm
Sharp

C: 25cm / 9 3/4"
15X20mm
Sharp

HP-11-01-0335 Volkman Bone Hook

REAMERS - AWLS - BONE HOOKS



Pointed

HP-11-01-0336

Kuntscher Diamond Awl 28 cm / 11"

Pointed

HP-11-01-0337

Rush Awl / Reamer

A: 19 cm / 7 1/2" 2.5mm

B: 21 cm / 8 1/4" 3mm

C: 21 cm / 8 1/2" 5mm

D: 26 cm / 10 1/2" 6mm

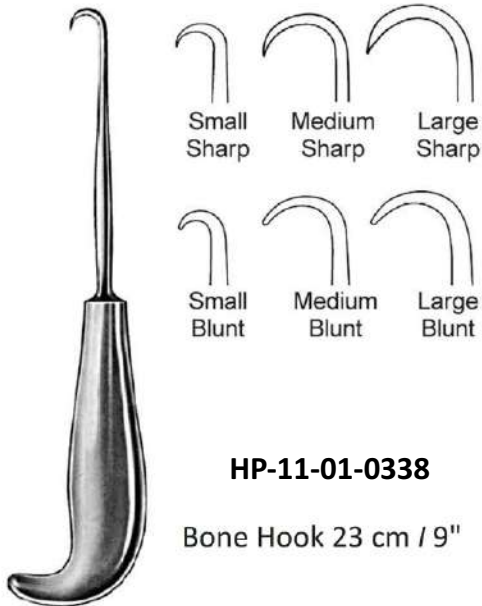

HP-11-01-0338
Bone Hook 23 cm / 9"

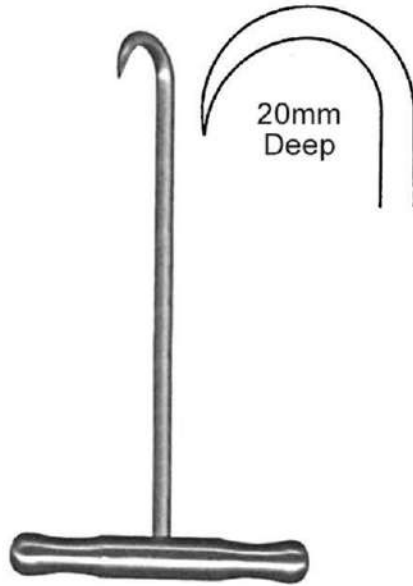

HP-11-01-0339

Bone Hook T Handle 20 cm / 8"



HP-11-01-0340

Bone Hook T Fiber Handle 14cm / 5 5/8"

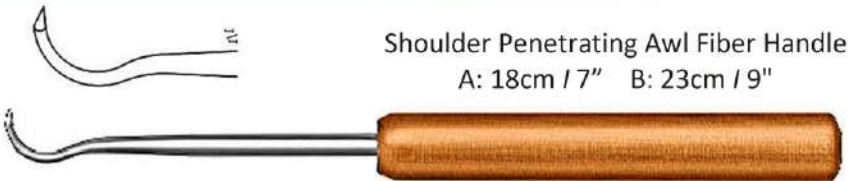

Shoulder Penetrating Awl Fiber Handle
A: 18cm / 7" B: 23cm / 9"

HP-11-01-0341



HP-11-01-0342

Pointed Awl Fiber Handle 25cm / 10"

ORTHOPEDIC HAND BONE DRILLS -ACC

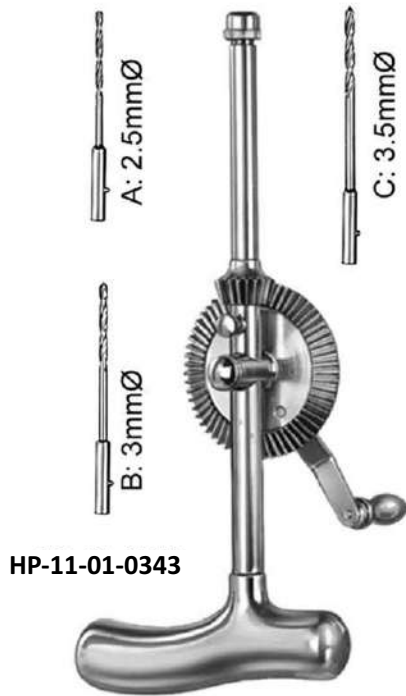

HP-11-01-0343

Stille-Sherman Hand Drill
24 cm / 9 1/2" with 3 twist drills

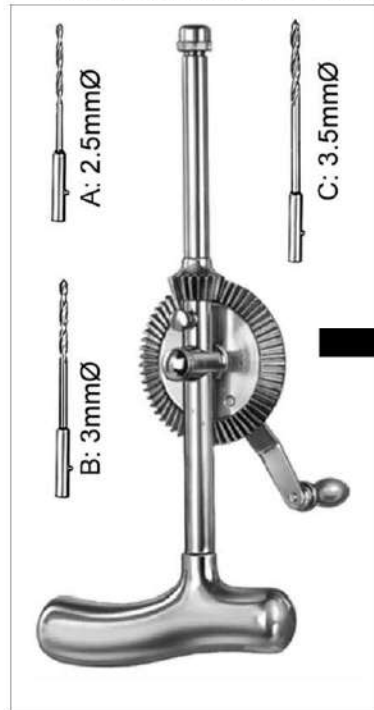

HP-11-01-0344 Stille Hand Drill 20.5 cm / 8" w / 9 Twist Drills

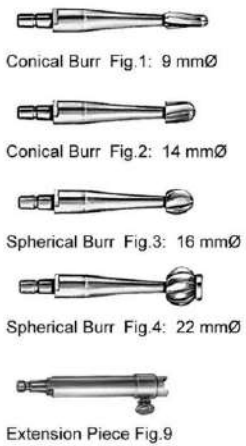
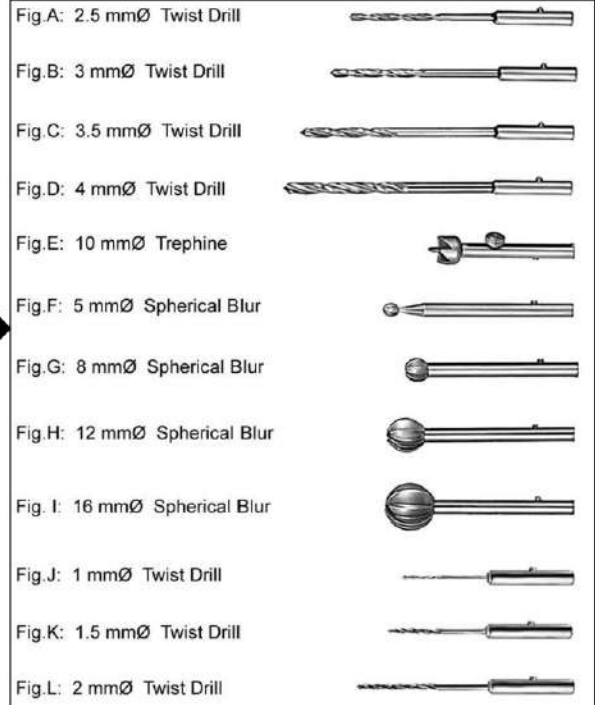

HP-11-01-0345

Hudson Hand Drill
28 cm / 11"
Complete with burrs Fig #. 1 - 4
& additional price for additional
accessories

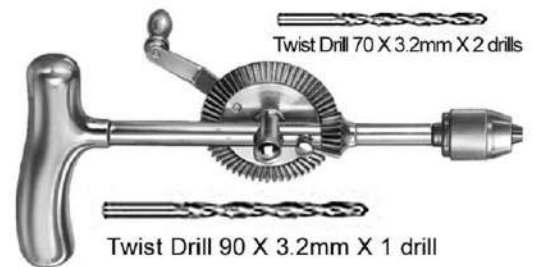
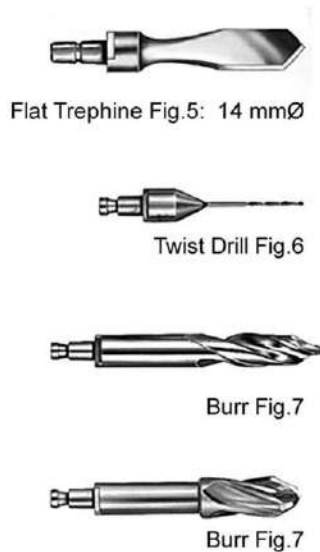
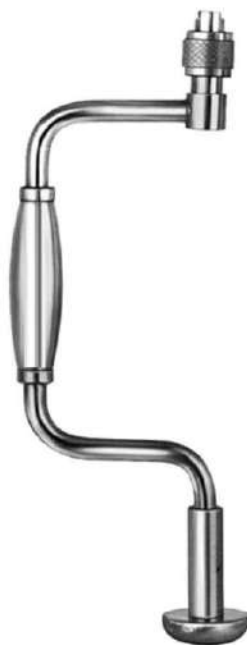

HP-11-01-0346 Moore Hand Drill
Complete with a set of 3 twist drills

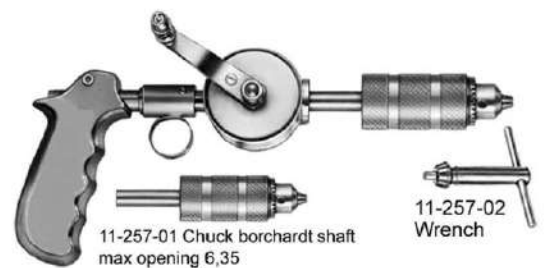

HP-11-01-0347
Martin Hand Drill with Chuck & Wrench

ORTHOPEDIC HAND BONE DRILLS -ACC



HP-11-01-0348

Bunnell Hand Drill
16cm / 6-1/4"

Longitudinally Bored with 3-Jaw-Chuek
Light Metal Housing opening up to 4mm



HP-11-01-0349

Bunnell Hand Drill
16cm / 6-1/4"

Twin Shade Powder Coated Longitudinally
bored with 3-Jaw-Chuek light metal
housing opening up to 4mm



HP-11-01-0350
Ralk Hand Drill

Light Metal Housing
Literally Angled Handle with 3-Jaw-Chuek
and key, opening up to 6,35mm

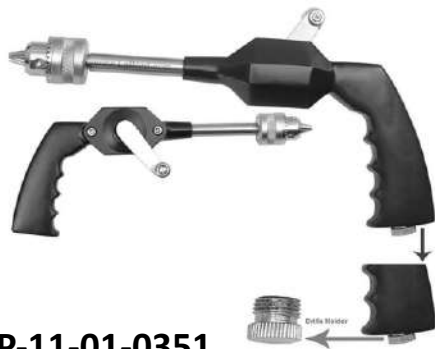

HP-11-01-0351

HAND DRILL
All Covered Polished / Dull or Coated.
Drills Holder at Bottom.



HP-11-01-0352

Hand Drill
All Covered Light Weight / Polished /
Dull or Coated. Key Holder and Self
Retaining Locking Mechanism



Box for Hand Drills
Outside Artificial Leather
/ inside Jumbo Foam



HP-11-01-0353

Hand Drill
Polished / Dull or Coated. Operated
Horizontally and Vertically

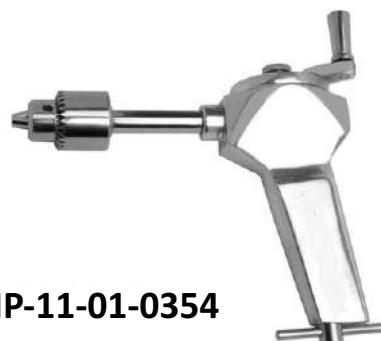

HP-11-01-0354

Hand Drill
Polished / Dull or Coated.
All Covered

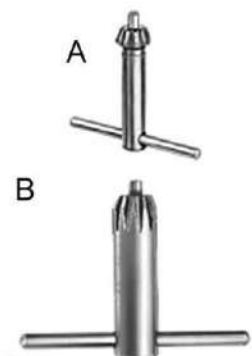

All Hand Drills
Provided with Keys

ORTHOPEDIC HAND BONE DRILLS -ACC



HP-11-01-0355

Hand Drill
Polished / Dull
Or Coated.
Open Housing



HP-11-01-0356

Hand Drill
Polished / Dull
Or Coated.
Open Housing



HP-11-01-0357

Hand Drill
Polished / Dull
Or Coated.
Semi Closed Housing



HP-11-01-0358

Vickers Easidriver 14 Cm / 5 1/2"



HP-11-01-0355

14 cm / 5 1/2"
Handle W/ Chuck Longitudinally
Bored Accommodating up to 3,95mm



HP-11-01-0360

Handle with chuck T-Shaped



HP-11-01-0361

Fiber T-Handle Key



HP-11-01-0362

Key



HP-11-01-0363

Key

ORTHOPEDIC DRILL BITS – BURS - TREPHINES



HP-11-01-01

5mm Borchardt Shaft Twist Drill, Long Working End

A: 2.0mm B: 2.5mm C: 3.0mm D: 3.2mm E: 3.5mm F: 4.0mm G: 5.0mm H: 6.0mm I: 7.0mm



HP-11-01-02

5mm Borchardt Shaft Twist Drill

A: 1.0mm B: 1.5mm C: 1.8mm D: 2.0mm E: 2.2mm F: 2.5mm G: 2.8mm H: 3.0mm I: 3.2mm J: 3.5mm K: 4.0mm L: 5.0mm



HP-11-01-03

5mm Borchardt Shaft Flat Trepine

A: 1.8mm B: 2.0mm C: 2.2mm D: 2.5mm E: 3.0mm F: 3.5mm G: 4.0mm H: 5.0mm



HP-11-01-04

5mm Borchardt Shaft Spherical Burr

A: 3.0mm B: 4.0mm



HP-11-01-05

5mm Borchardt Shaft Spherical Burr

A: 3.0mm B: 5.0mm



Long 5mm Borchardt Shaft

HP-11-01-06

Doyen Spherical Burr

A: 4mm B: 6mm C: 8mm D: 10mm E: 12mm F: 14mm G: 16mm

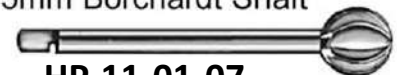

Short 5mm Borchardt Shaft

HP-11-01-07

Doyen Spherical Burr

A: 4mm B: 6mm C: 8mm D: 10mm E: 12mm F: 14mm G: 16mm

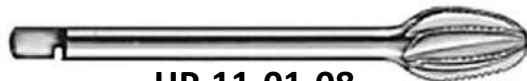

HP-11-01-08

Doyen Conical Burr

Coarse Spacing 12mm Dia

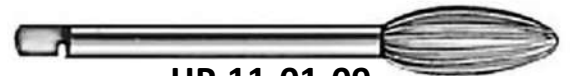

HP-11-01-09

Doyen Conical Burr

Fine Spacing A: 8mm / B: 10 mm



HP-11-01-10

Doyen Cylindrical Burr

Coarse Spacing A: 12mm / B: 15mm



HP-11-01-11

Albee Burr Oval Coarse Spacing

A: 8mm / B: 10 mm / C: 12 mm



HP-11-01-12

Albee Burr Pointed 7 mm



HP-11-01-13

Borchardt Burr Oval Coarse Spacing 13mm



HP-11-01-14

Flat Burr Short Borchardt Shaft 25mm



HP-11-01-15

Toti Trepine Short Borchardt Shaft 8mm

BONE HOLDING CLAMPS – TRACTION BAR



HP-11-01-0364 Gerster-Lowman Bone Holding Clamp

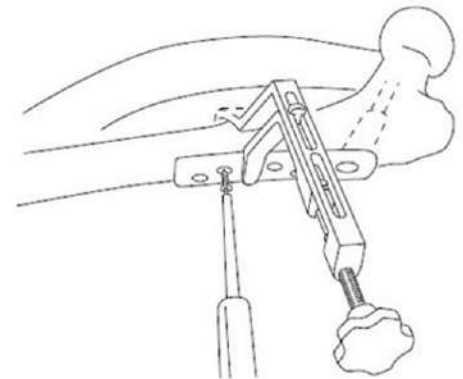
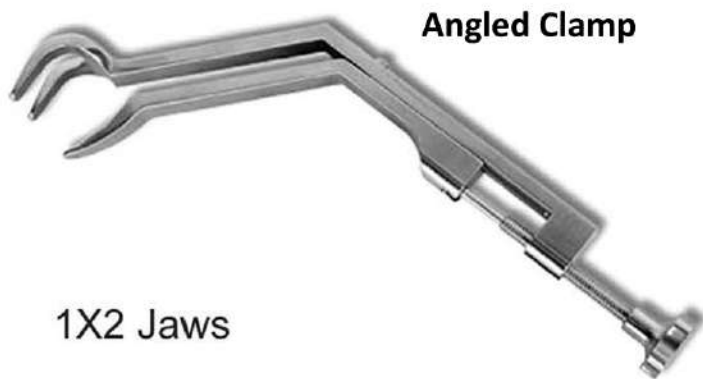
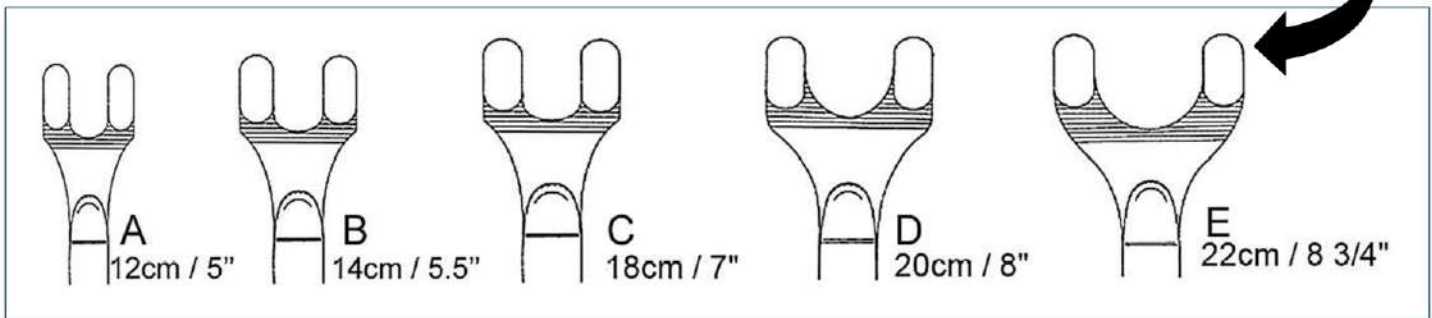
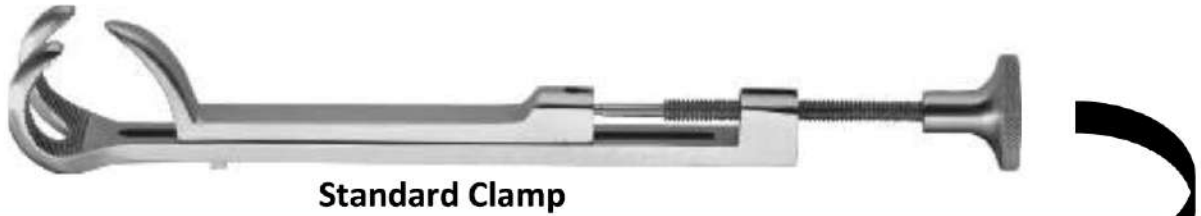

HP-11-01-0365 Gerster-Lowman Bone Holding Clamp

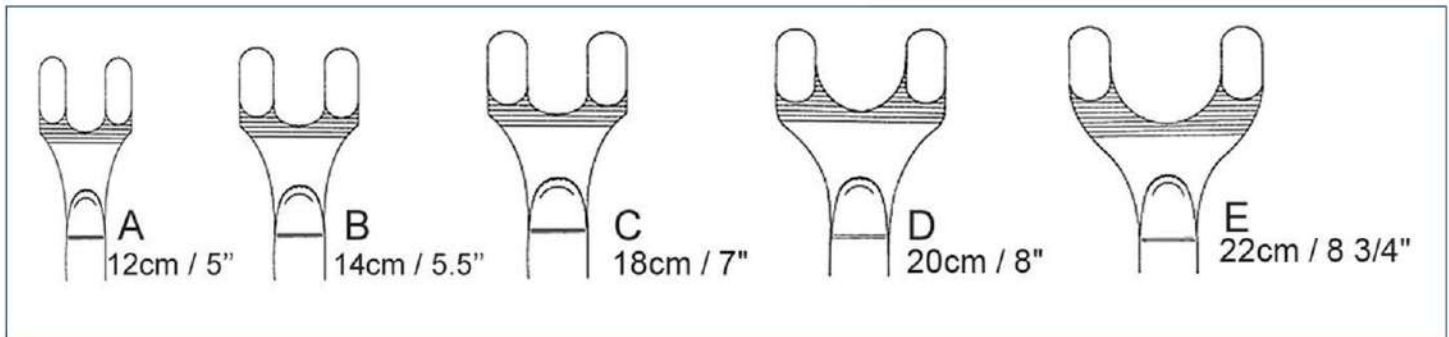

BONE HOLDING CLAMPS – TRACTION BAR



HP-11-01-0366 Gerster Traction bar 15 cm / 6"

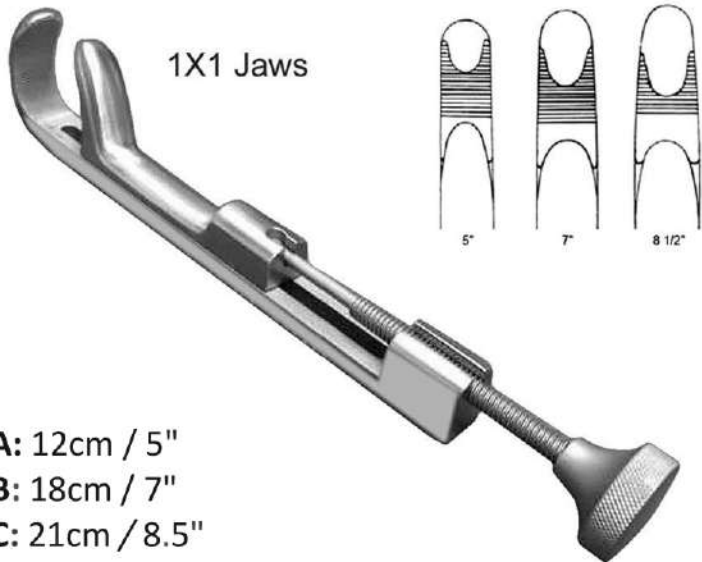

HP-11-01-0367
Gerster-Lowman Bone Holding Clamp

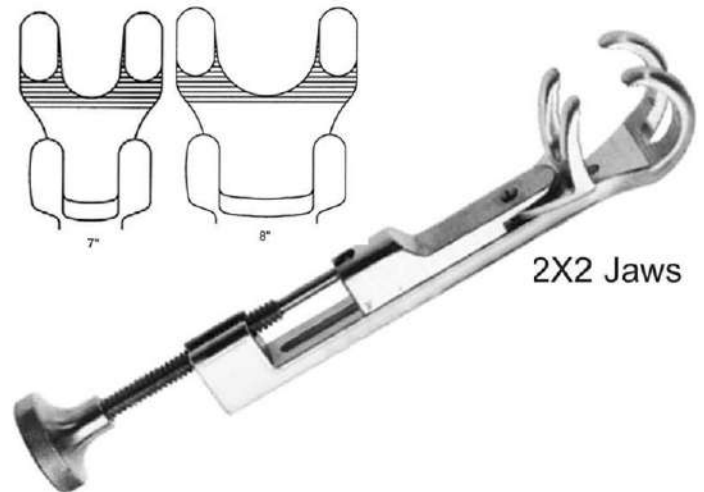

HP-11-01-0368
Gerster-Lowman Bone Holding Clamp

WISE GRIPS – NOSE PLIERS – SLAP HAMMERS [ALL MADE OF STAINLESS STEEL]



HP-11-01-0369
Vise Grip Locking Plier 23 cm / 9"



HP-11-01-0370
Vise Grip Locking Plier 20.5 cm / 8"



HP-11-01-0371
Vise Grip Locking Plier 18 cm / 7"



HP-11-01-0372
Needle Nose Locking Plier 30 cm / 12"

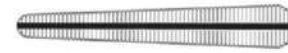

HP-11-01-0373
Needle Nose Locking Plier 25.5 cm / 10"



HP-11-01-0374
Needle Nose Locking Plier 22 cm / 8.5"



HP-11-01-0375
Flat Nose Plier 18.5 cm / 7 1/4" Parallel Grip SS



Max 1.6mm Cutting Capacity

HP-11-01-0376
Flat Nose Plier-Cutter 18.5 cm / 7 1/4" Parallel Grip SS



HP-11-01-0377
Long Nose Plier 22 cm / 8 1/4"



HP-11-01-0378
Vise Grip 20.5 cm / 8" Stainless Steel

VICE GRIPS – NOSE PLIERS – SLAP HAMMERS [ALL MADE OF STAINLESS STEEL]



HP-11-01-0379

Regular Jaw Locking Plier

A: 18 cm / 7" B: 20 cm / 8" C: 23 cm / 9"



HP-11-01-0380

Needle Nose Locking Plier

A: 22 cm / 8.5" B: 25.5 cm / 10" C: 30 cm / 12"



HP-11-01-0381

SLAP HAMMER w/ Threaded Shaft Head



HP-11-01-0382

SLAP HAMMER w/ Hexa Shaft Head



HP-11-01-0383

Combi-Fiat Nose Pliers 15 cm / 6"

For Bending & Cutting



HP-11-01-0385

Flat Nose Plier 13.5 cm / 5 1/4"



HP-11-01-0384

Round / Flat Nose Pliers 18 cm / 7"



HP-11-01-0386

Hackstock Flat Nose Pliers 16 cm / 6 1/4"

NOSE PLIERS – PULLING FORCEPS – WIRE CUTTERS

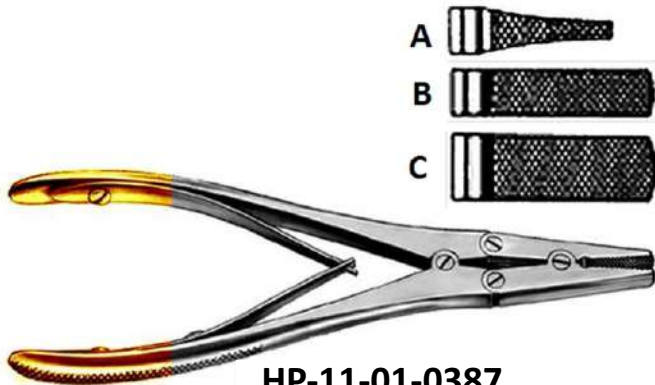

HP-11-01-0387
Flat Nose Pliers 18 cm / 7" Parallel Grip



HP-11-01-0388
Flat Nose Pliers 17 cm / 6 ¾" with crosswise groove



HP-11-01-0389
Flat Nose Pliers 17.5 cm / 7"



HP-11-01-0390
Flat Nose Pliers Pointed 19.5 cm / 7 ¾"



HP-11-01-0391
Platypus Nail Pulling Forceps 15.5 cm / 6 ¼"

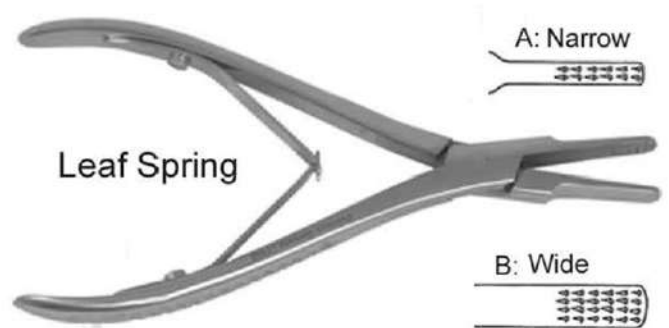

HP-11-01-0392
Platypus Nail Pulling Forceps 15.5 cm / 6 ¼"



HP-11-01-0393
Round Nose Pliers 15.5 cm / 6 ¼"

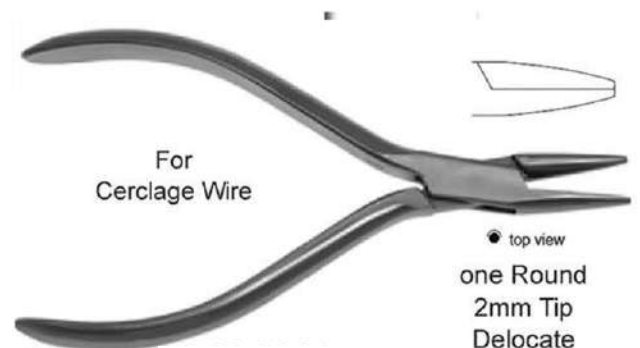

HP-11-01-0394
Needle Nose Pliers 15.5 cm / 6 ¼"

NOSE PLIERS – PULLING FORCECEPS – WIRE CUTTERS

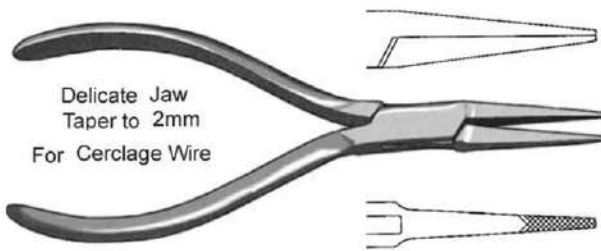

HP-11-01-0395

Flat Nose Pliers 15 cm / 6"

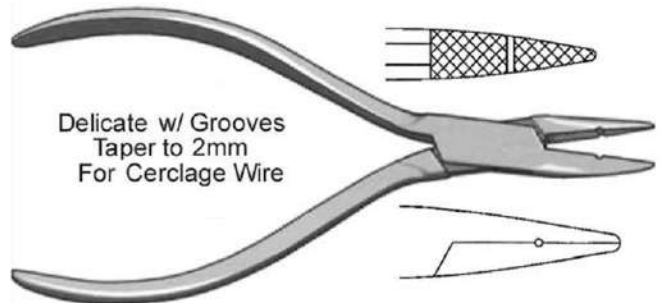

HP-11-01-0396

Needle Nose Pliers 13.5 cm / 5 ¼"

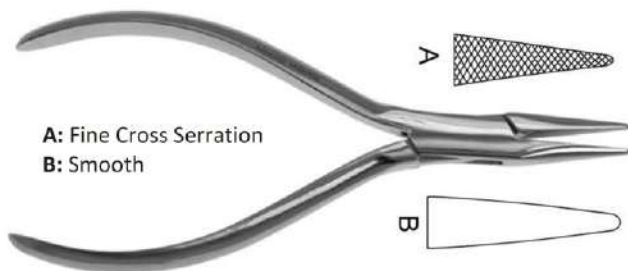

HP-11-01-0397

Needle Nose Pliers Taper to 2mm Tip 14 cm / 5 ½"



HP-11-01-0398

Wire Cutting Pliers 18.5 cm / 7 ¼"



HP-11-01-0399

Martin "Diamant" 16cm / 6 ¼"



HP-11-01-0400

Circlage Pliers / Cutter 14 cm / 5 ½"

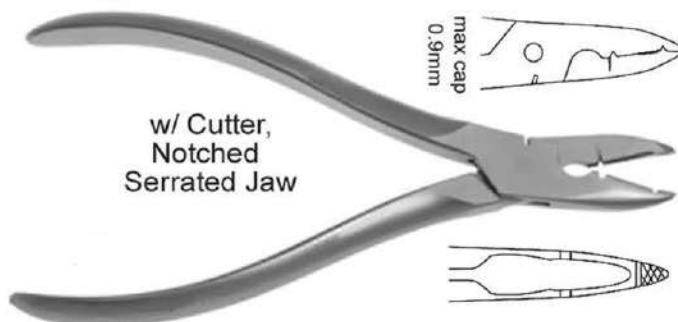

HP-11-01-0401

Wire Bending Pliers 20 cm / 8"

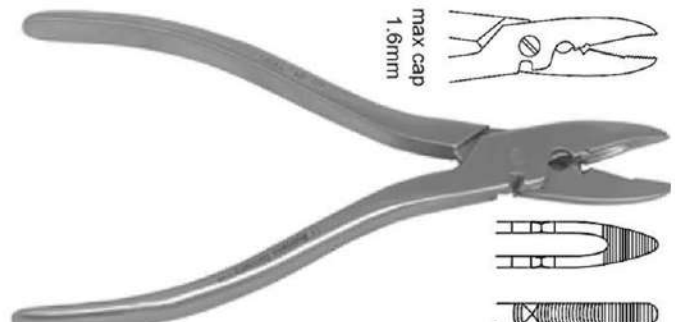

HP-11-01-0402

Wire Bending Pliers 15 cm / 6"

NOSE PLIERS – PULLING FORCECEPS – WIRE CUTTERS



HP-11-01-0403
Wire Bending Pliers TC 20 cm / 8"

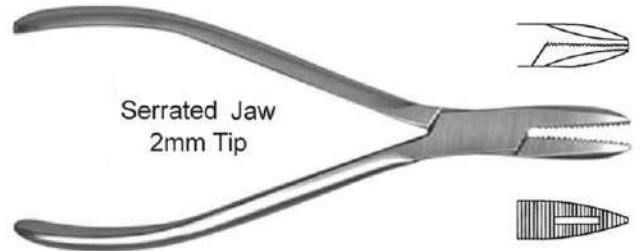

HP-11-01-0404
Needle Nose Pliers 15 cm / 6"

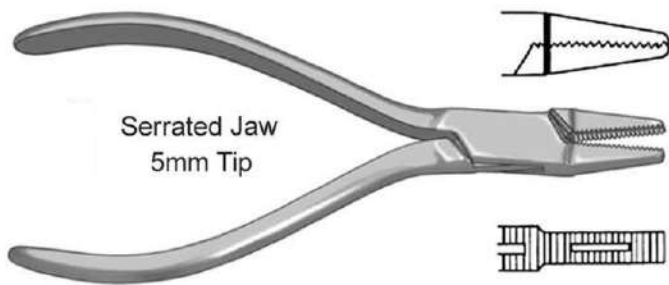

HP-11-01-0405
Flat Nose Pliers 14 cm / 5 1/2"

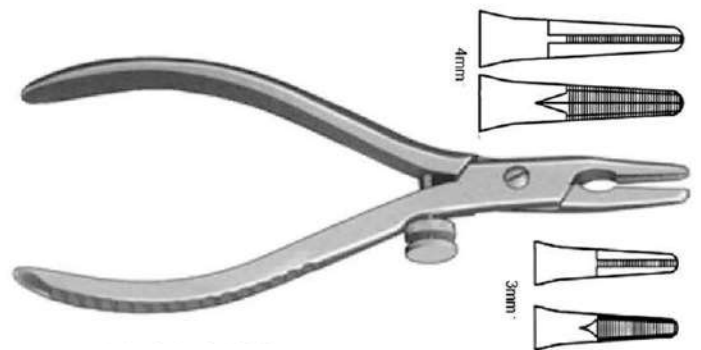

HP-11-01-0406
K-Wire Pliers A: 13 cm / 5" B: 17.5 cm / 7"



HP-11-01-0407
Screw/Pin Removing Pliers 19 cm / 7 1/2"

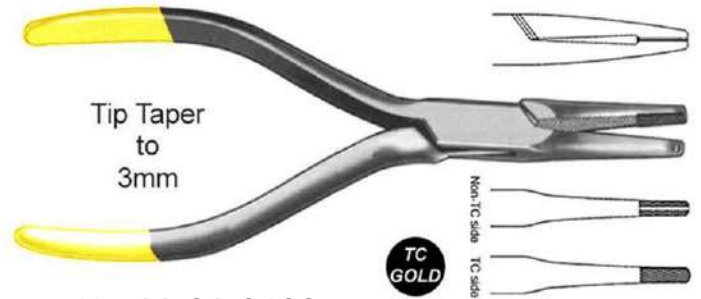

HP-11-01-0408
Pin Puller Grips Small Pins 14 cm / 5 1/2"



HP-11-01-0409
Flat Nose Pliers w/ Cutter for Cerclage Wire 16 cm / 6 1/2"

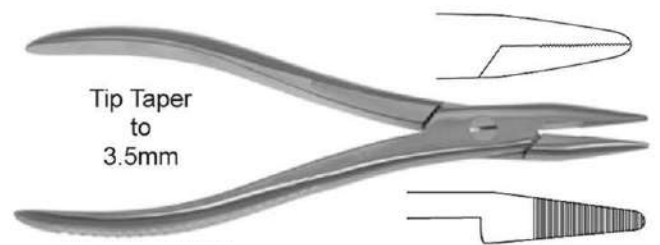

HP-11-01-0410
19 cm / 7 1/2" Narrow Nose Pliers Heavy Jaws
for Pulling Wire / Pins

PLIERS – BENDERS – ROD INSTRUMENTS

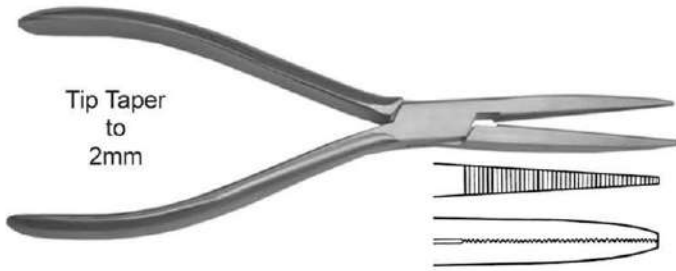

HP-11-01-0411

Long Jaw Pliers 2inch Long Jaw Delicate 17.5 cm / 7"

- A: 17.5 cm / 7" Needle Nose 2" Jaw
- B: 16 cm / 6 1/2" Square 7mm Jaw
- C: 18 cm / 7" Tape to 2mm Tip

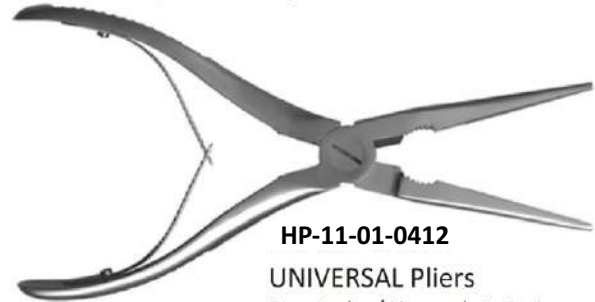
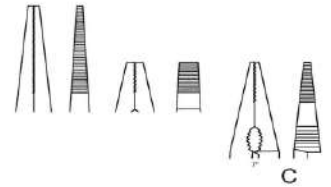

HP-11-01-0412

UNIVERSAL Pliers
Serrated w/ Heavy duty Spring and Cutting Edge
Max Cutting Cap: 1.1 mm

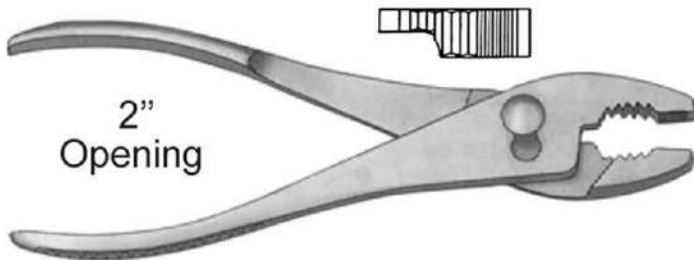

HP-11-01-0413

Slip Joint Pliers 20 cm / 8"

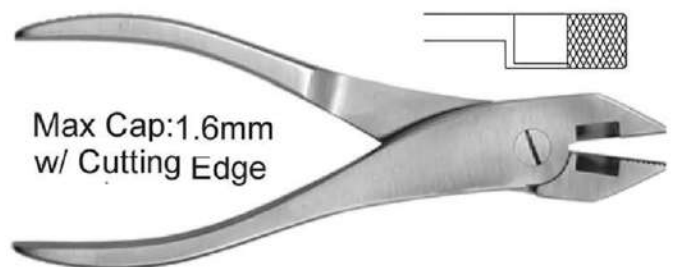

HP-11-01-0414

Lineman Pliers 21 cm / 8 1/2"

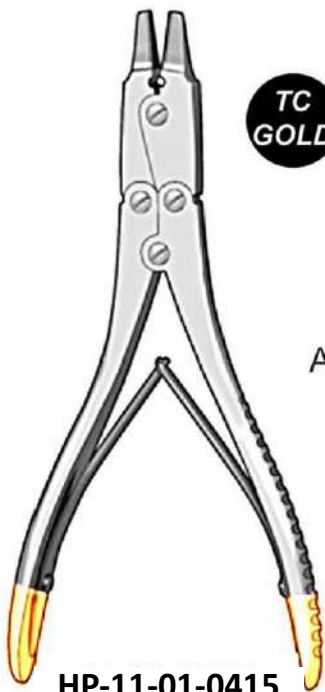

TC GOLD

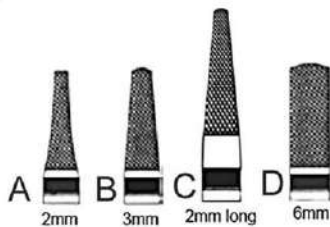

- A: 2mm Delicate Jaw TC
- B: 3mm Jaw TC
- C: 2mm Long Jaw TC
- D: 6mm Jaw TC

HP-11-01-0415

Double Action Wire Extraction Plier
18 cm / 7"

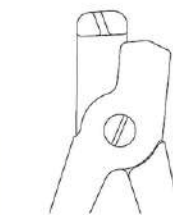

HP-11-01-0416

Gratloch Wire Bender
19 cm / 7 1/2"



Max Cap: 1.6mm

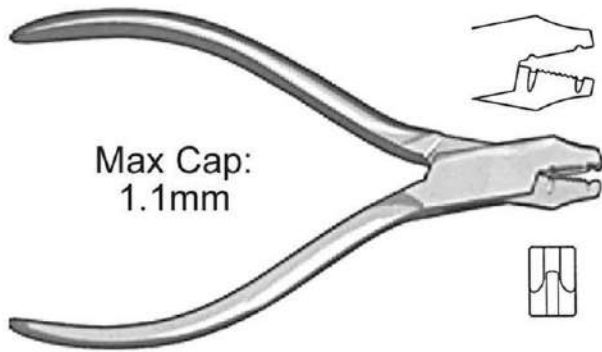

Max Cap:
1.1mm

HP-11-01-0417

K-Wire / Plate Bender 13.5cm / 5"

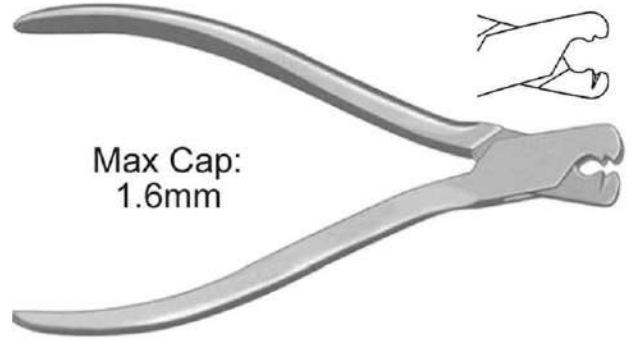

Max Cap:
1.6mm

HP-11-01-0418

K-Wire / Plate Bender 14.5 cm / 5 ½"

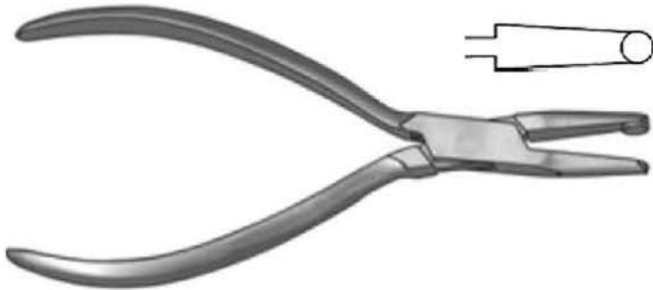

HP-11-01-0419

Mini Plate Bending Pliers 13.5 cm / 5"

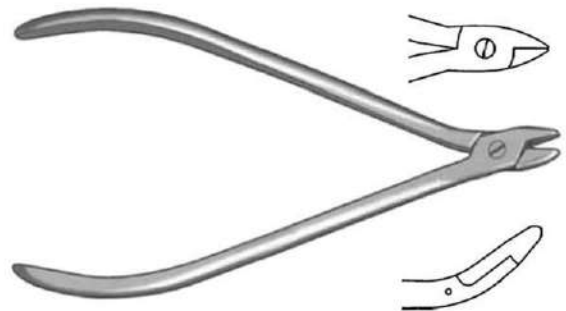

HP-11-01-0420

Plate Bending Pliers 14.5 cm / 5 ½"

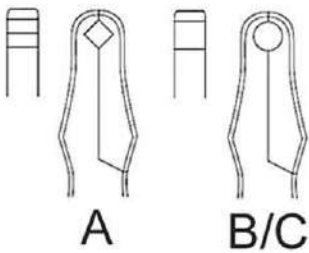

- A: 5.5mm Rods Prism
- B: 5.5mm Rods
- C: 6.35mm Rods

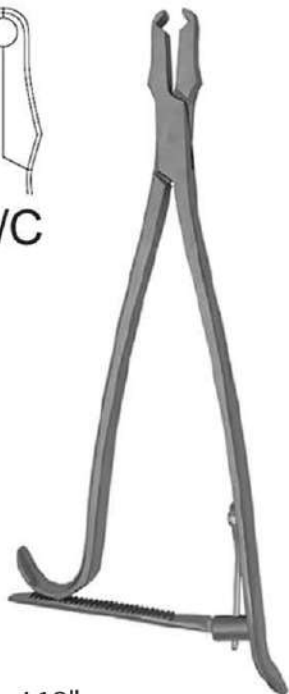

HP-11-01-0421

Rod Holder STR 25 cm / 10"



HP-11-01-0422

Rod Gripper Adjustable
21 cm / 8 ½"

WIRE INSTRUMENTS – EXTENSION BOWS

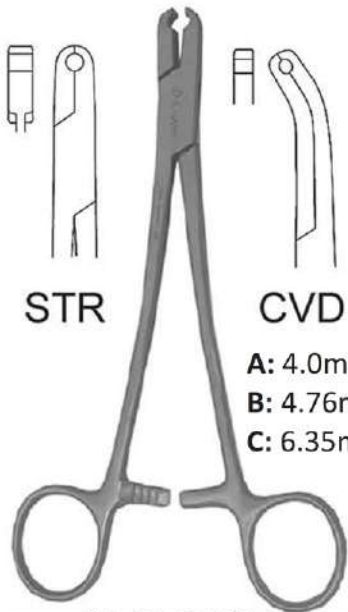

STR

CVD

- A: 4.0mm Rod
- B: 4.76mm Rod
- C: 6.35mm Rod

HP-11-01-0423

Rod Holder 18 cm / 7 ¼"



HP-11-01-0424

Wire Pulling Forceps 16 cm / 6 ½"

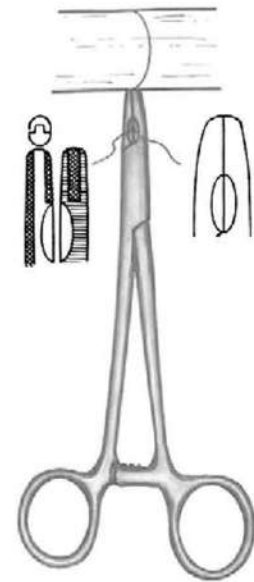

HP-11-01-0425

Wire Twister / Tightner 16cm / 6 ¼"



HP-11-01-0426

Loute Wire Tightener 21 cm / 8 ¼"



HP-11-01-0428

Wire Tightener w / T Handle
11.5 cm / 4 ½"



HP-11-01-0427

Wire Tightener 12 cm / 4 ¾"

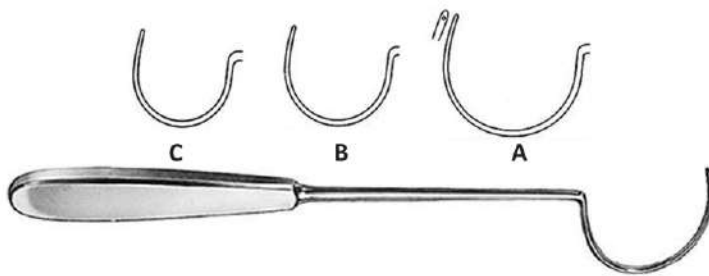

A: 31 cm / 12 ¼"
B: 29 cm / 11 ½"
C: 28 cm / 11"

HP-11-01-0429
Demel Wire Guide

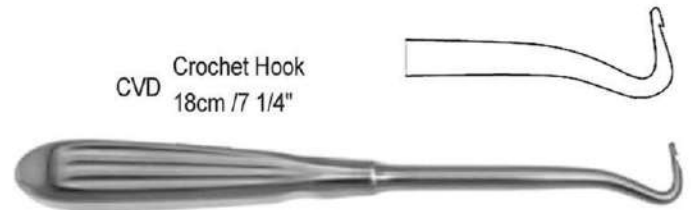

CVD Crochet Hook
18cm / 7 1/4"

HP-11-01-0430
Bankert Ligature Carrier

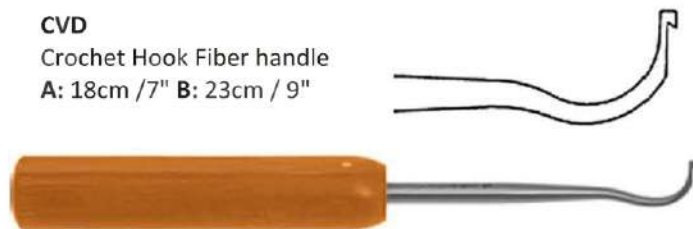

CVD
Crochet Hook Fiber handle
A: 18cm / 7" B: 23cm / 9"

HP-11-01-0431
Suture Passer

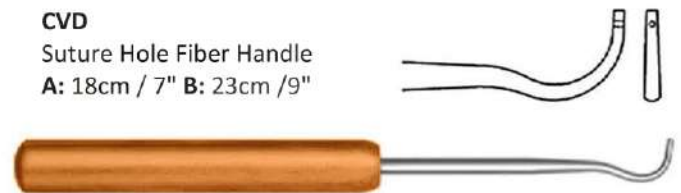

CVD
Suture Hole Fiber Handle
A: 18cm / 7" B: 23cm / 9"

HP-11-01-0432
Suture Passer



Suture Hole
20cm / 8"
A: Right Blunt
B: Left Blunt
C: Right Sharp
D: Left Sharp

HP-11-01-0433
Deschamps Ligature Carrier

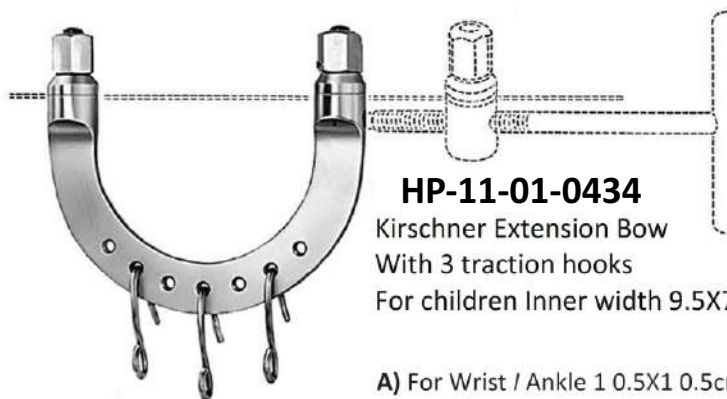

HP-11-01-0434
Kirschner Extension Bow
With 3 traction hooks
For children Inner width 9.5X7cm

- A) For Wrist / Ankle 1 0.5X1 0.5cm
- B) For Elbow 12X12cm
- C) For Knee 15.5X15.5cm
- D) For Femur 20X15.5cm

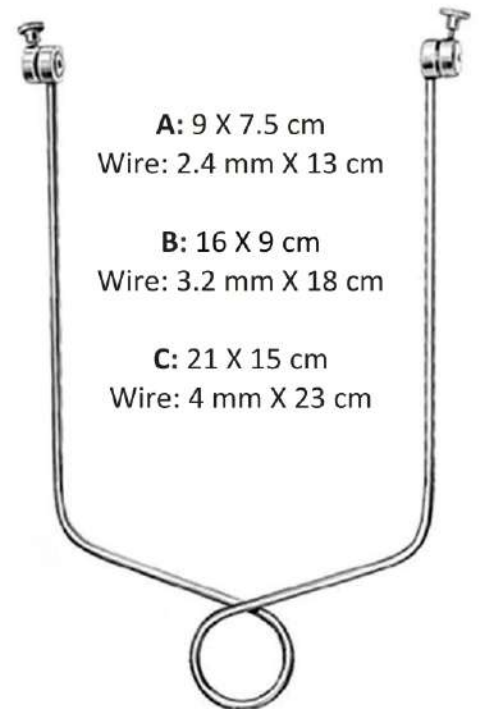

A: 9 X 7.5 cm
Wire: 2.4 mm X 13 cm

B: 16 X 9 cm
Wire: 3.2 mm X 18 cm

C: 21 X 15 cm
Wire: 4 mm X 23 cm

HP-11-01-0435
Bohler Extension Bow for femur & knee

WIRE INSTRUMENTS – EXTENSION BOWS

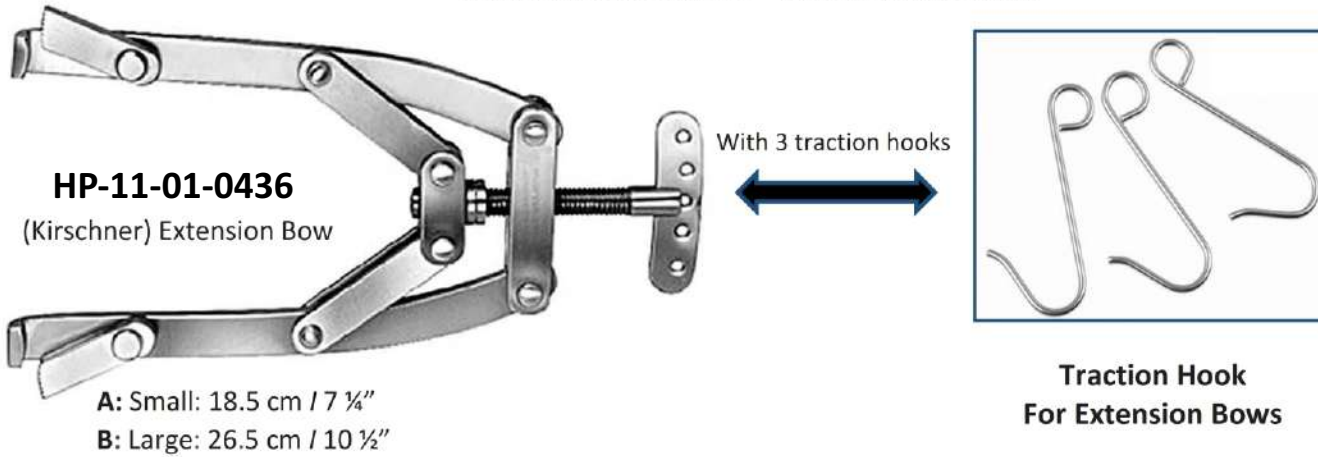

HP-11-01-0437
Extension Bow
A: 10 ½" X 6 ¼"
B: 7" X 4"



HP-11-01-0438
Wire Strainer 18.5 cm / 7 ¼"



HP-11-01-0439
Wrench 20 cm / 8"



HP-11-01-0440
Fixation Discs
For wire drills, pair

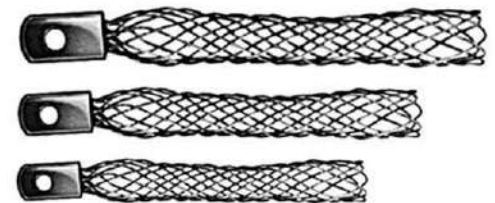

HP-11-01-0441
Extension Sleeve
Small / Medium / Large

RING CUTTERS – LEAD HANDS – BIOPSY TOOLS



Complete with Drills
(Set of 3 drills) Small / Medium / Large

HP-11-01-0442
Martin-Ideal
Finger Nail Drill



HP-11-01-0443
Feldheim Tourniquet 10 cm / 4"

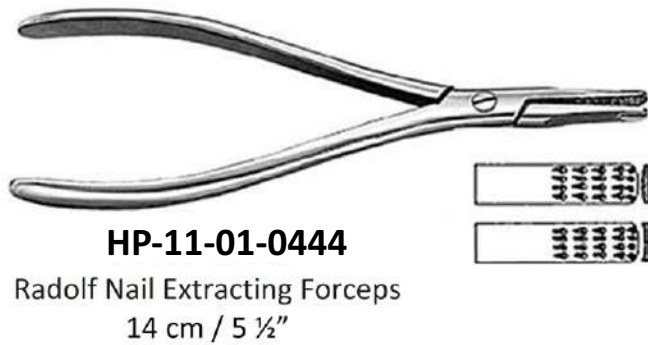

HP-11-01-0444
Radolf Nail Extracting Forceps
14 cm / 5 ½"

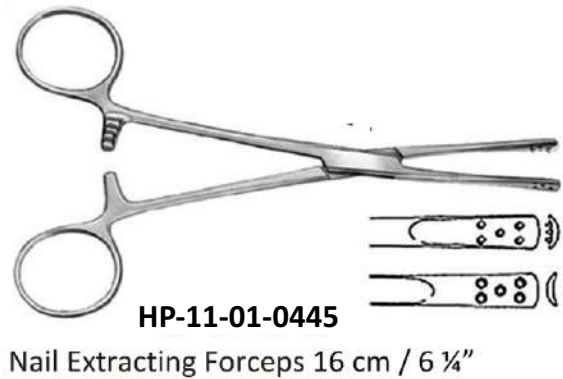

HP-11-01-0445
Nail Extracting Forceps 16 cm / 6 ¼"



HP-11-01-0446
Martin Finger Ring Saw 18.5 cm / 6 ¾"
Spare Blades are Available Separately



HP-11-01-0447
Walton Finger Ring Saw 16cm / 6 ¼"
Spare Blades are Available Separately



HP-11-01-0448
Finger Ring Saw 17cm / 6 ¾"
Spare Blades are Available Separately

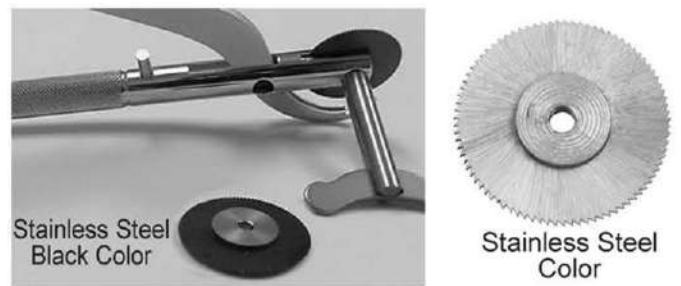

Stainless Steel
Black Color

Stainless Steel
Color

HP-11-01-0449
Finger Ring Saw Cutter Spare

RING CUTTERS – LEAD HANDS – BIOPSY TOOLS



HP-11-01-0450

Lead Hand for Kids / Adults

HP-11-01-0451

Lead Hand for Kids / Adults

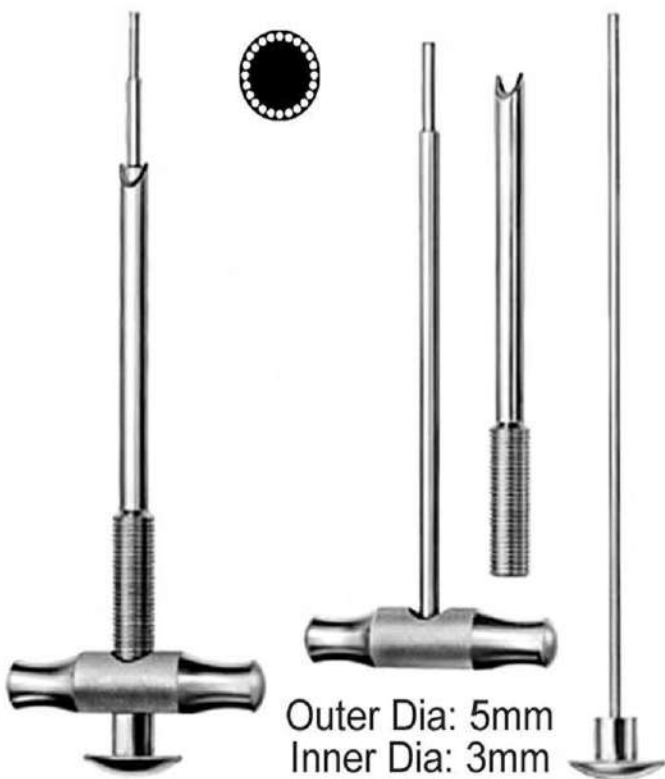

Outer Dia: 5mm
Inner Dia: 3mm

HP-11-01-0452

Champy-OSU Bone Biopsy Instruments

22 cm / 8 ¾"

Consisting of trocar, a toothed trephine and a plunger for taking tibial and iliac bone grafts through a closed technique



HP-11-01-0453

Champy Bone Biopsy Instruments

22 cm / 8 ¾"

- A) Outer Dia: 5mm / Inner Dia: 4mm
- B) Outer Dia: 8mm / Inner Dia: 7mm

BONE TAMPERS – IMPACTORS - PACKERS



HP-11-01-0454

Bone Tamper
15.5 cm / 6" Tip
Sizes: 2-3-4-5-6-8-9-10 mm



HP-11-01-0455

Champy Cancellous Bone graft Mill

Outer Dia: 17mm
Inner Dia: 16mm



HP-11-01-0456

Bone Impactor / Teflon Tip 17cm / 6 1/2"



HP-11-01-0457

Caspar Bone Tamper 20 cm / 8"



HP-11-01-0458

Lumbar / Cervical Impactor 21cm / 8 1/2"

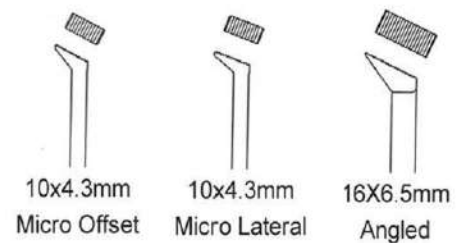

HP-11-01-0459

Lumbar / Cervical Impactor 21cm / 8 1/2"

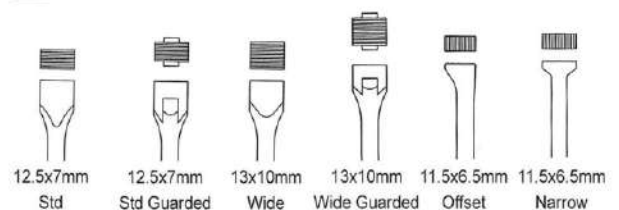

BONE RASPS - FILES



HP-11-01-0460

Bone Chip Packer 25cm / 10"

A: 2x9mm B: 3x16mm
C: 6x9mm D: 6x19mm
E: 6mm Dia

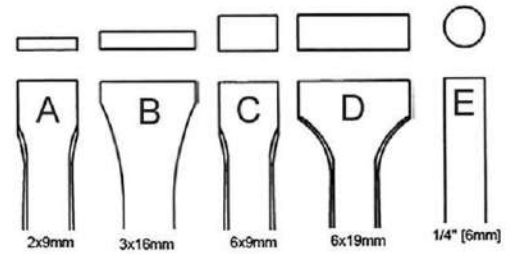

HP-11-01-0461

Bone Tamper 43 cm / 17"



HP-11-01-0462

Putti Bone Rasp Round / Semi Round
30 cm / 11 3/4"



HP-11-01-0463

Putti Bone Rasp Curved / Straight
27cm / 10 3/4"



HP-11-01-0464

Bone File 28 cm / 11" w/ Hollow Handle Semi Round



HP-11-01-0465

Bone File 24.5 cm / 9 3/4" w/ Hollow Handle Semi



HP-11-01-0466

Bone File 22 cm / 8 3/4" Flat / Round



HP-11-01-0467

Bone Rasp 22 cm / 8 3/4" Flat / Round



HP-11-01-0468

Bone File Fiber Handle 18cm / 7"

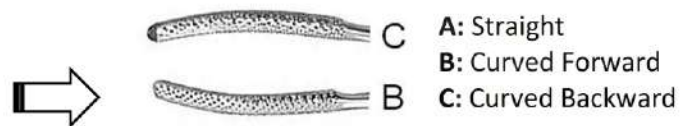

HP-11-01-0469

Bone File 18 cm / 7" Fiber Handle / Cross-Hatch



HP-11-01-0470

Bone File 18 cm / 7" Fiber Handle / Linear

BONE RASPS - FILES



HP-11-01-0471A

Bone File 18 cm / 7" Fiber Handle / STR Diamond Coated



HP-11-01-0471B

Bone File 18 cm / 7" Fiber Handle / CVD Diamond Coated

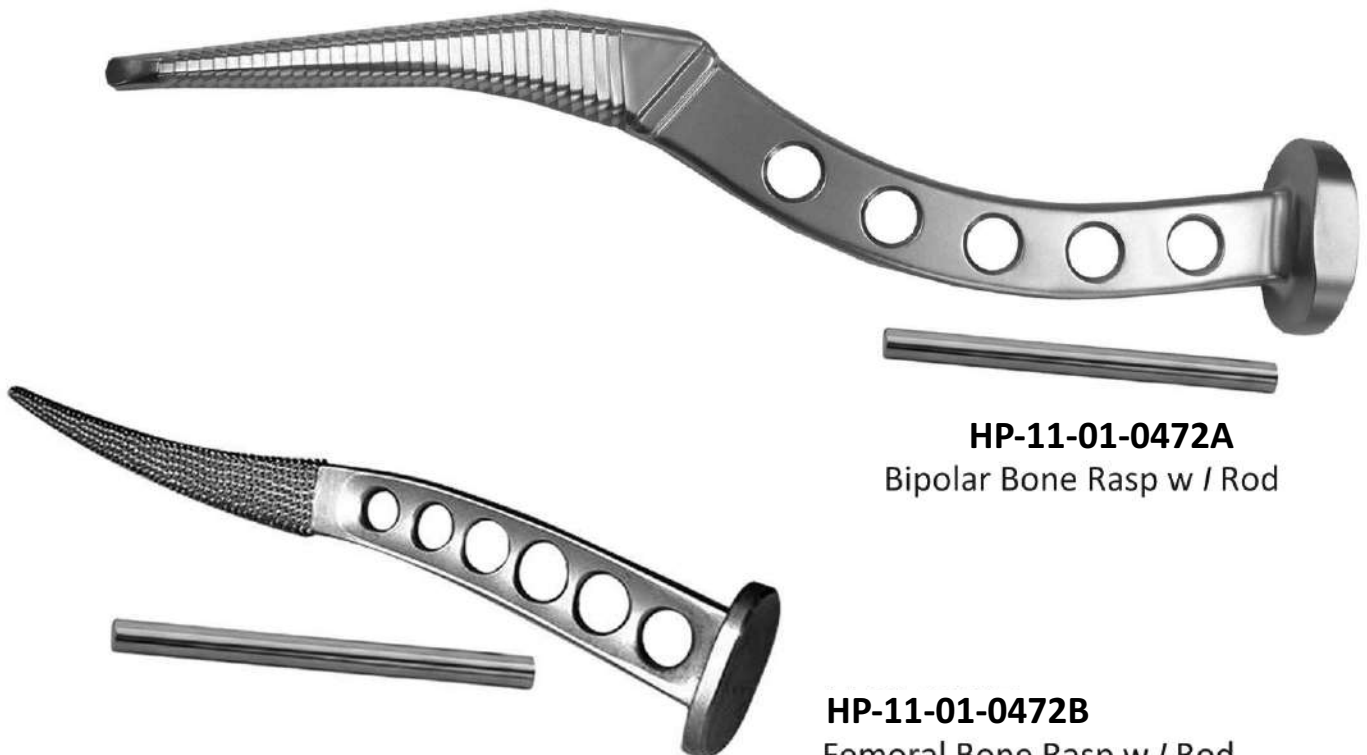

HP-11-01-0472A

Bipolar Bone Rasp w / Rod

HP-11-01-0472B

Femoral Bone Rasp w / Rod

A: Small B: Medium C: Large

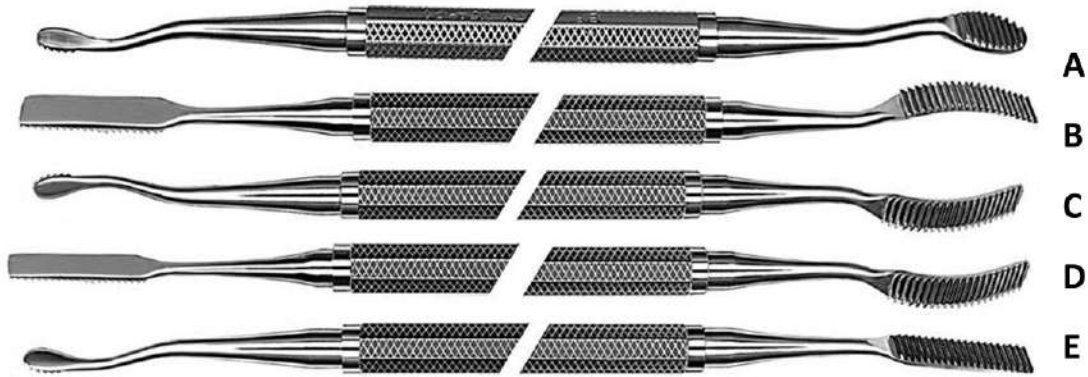

HP-11-01-0473

Miller-Colburn Bone File 18 cm / 7" Downwards Cut

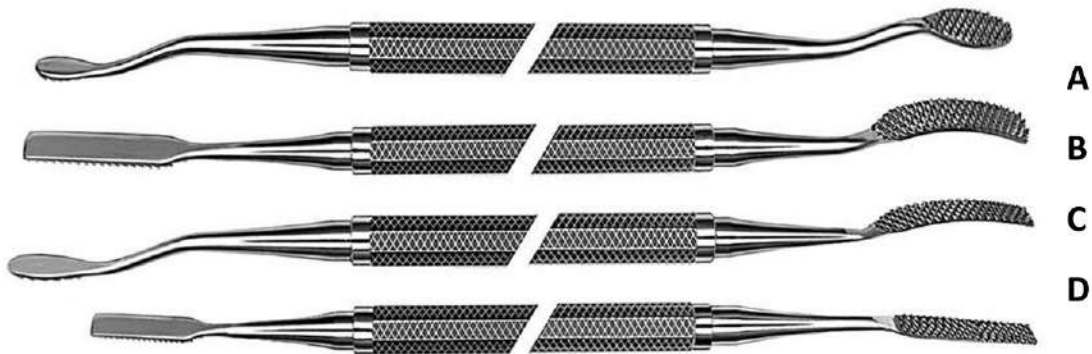

HP-11-01-0474

Miller-Colburn Bone File 18 cm / 7" Cross Cut

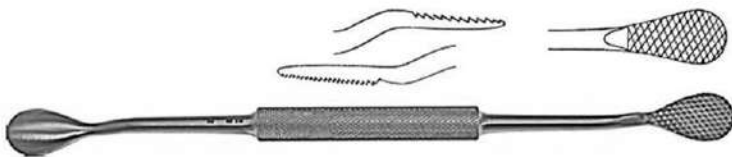

HP-11-01-0475

Bone Rasp 21 cm / 8.5" 13mm Fine/Coarse Straight

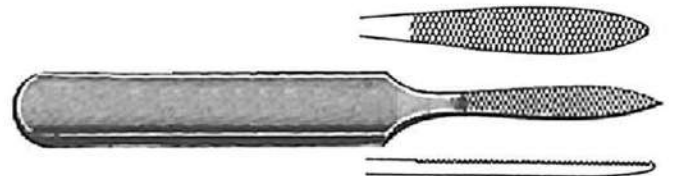

HP-11-01-0476

Bone Rasp Joseph 16 cm / 6.25" 8mm Fine Cross Serrated / Straight



HP-11-01-0477

Bone Rasp Lewis 19 cm / 7.5" 8mm

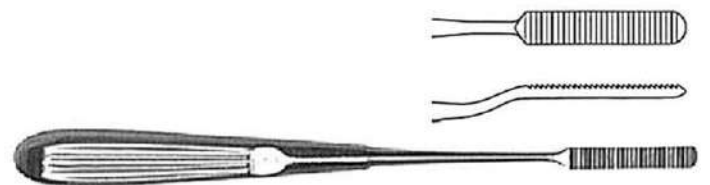

HP-11-01-0478

Bone Rasp Cottle 20 cm / 8" 7mm Plain Serrated Downward

BONE RASPS - FILES

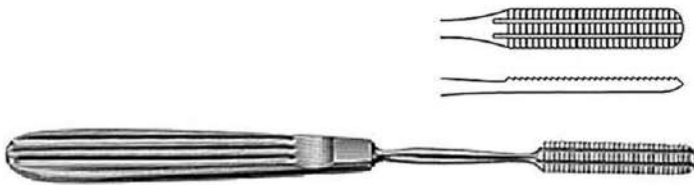

HP-11-01-0479

Bone Rasp Maltz 18 cm / 7"
9mm Plain Coarse Serr Downward



HP-11-01-0480

Bone Rasp Aufrieht 18 cm / 7"
9mm Coarse Serr CVD

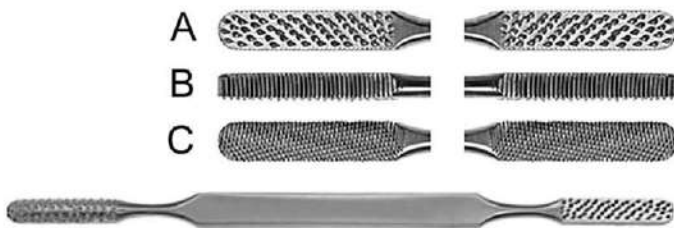
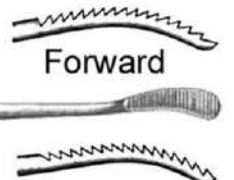

HP-11-01-0481

Bone Rasp Fomon 21 cm / 8.5"
8mmX40mm Course Serr 4 Sided Flat / Convex Baldes



HP-11-01-0482

Bone Rasp Fomon 21 cm / 8.5"
8mmX40mm Fine Serr 4 Sided Flat / Convex Blades

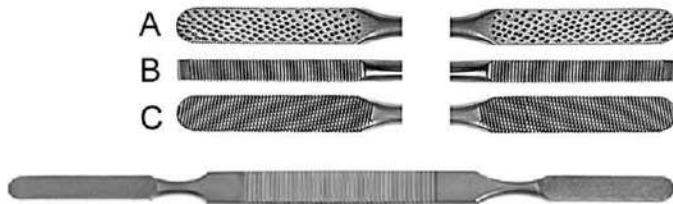

HP-11-01-0483

Bone Rasp Kleinert Kurtz 21 cm / 8.5"
8mmX45mm Fine/Coarse Serr 4 Sided Flat / Convex



HP-11-01-0484

Bone File / Rasp 21 cm / 8.5"
18mm Fine / Coarse Serr

BONE LEVERS - RETRACTORS



HP-11-01-0485
Bone Lever 16 cm / 6 ¼"



HP-11-01-0486
Hohman, Mini Bone Lever 16 cm / 6 ¼" 6 mm tip



HP-11-01-0487
Hohman, Mini Bone Lever 16 cm / 6 ¼" 8 mm tip



HP-11-01-0488
Mini Bone Lever 16cm / 6 ¼" 14 mm tip

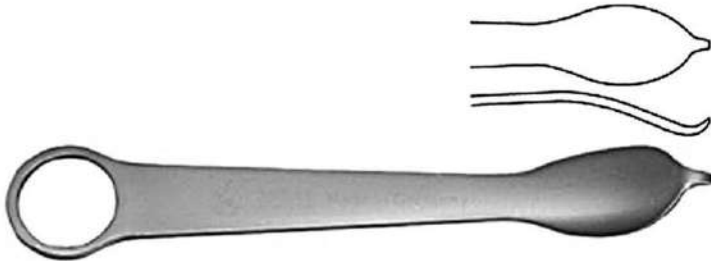

HP-11-01-0489
Hohman, Mini Bone Lever 12 cm / 4 ¾" 14 mm tip

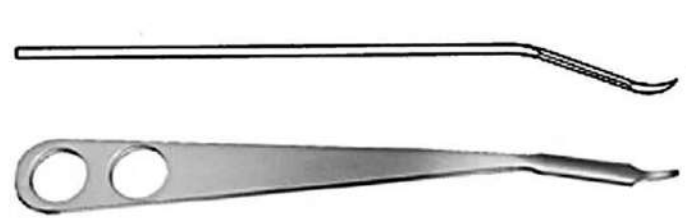

HP-11-01-0490
Hohmann Bone Lever 22 cm / 8 ¾" 8 mm Tip narrow tip

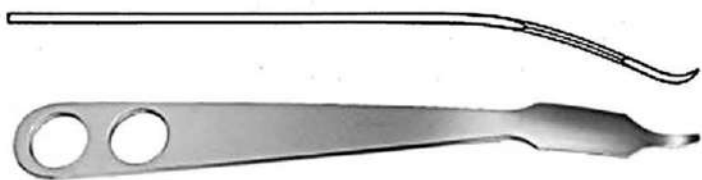

HP-11-01-0491
Hohmann Bone Lever 23.5 cm / 9 ¼" 18 mm Tip narrow tip



HP-11-01-0492
Hohmann Bone Lever 23.5 cm / 9 ¼" 43 mm Tip narrow tip



HP-11-01-0493
Hohmann Bone Lever 29 cm / 11 ½" 35mm Tip wide tip



HP-11-01-0494
Lange-Hohmann Bone Lever 25 cm / 9 ¾" 22mm Tip
Wide tip with groove

BONE LEVERS - RETRACTORS

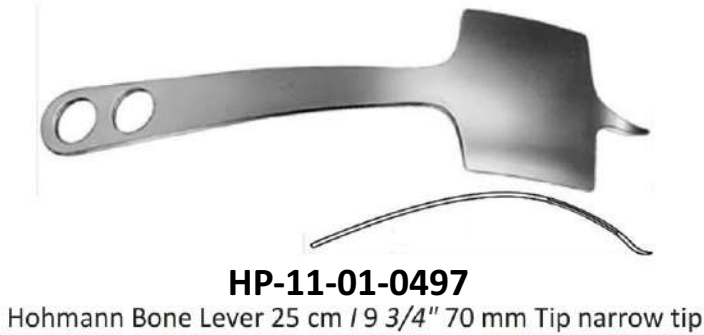
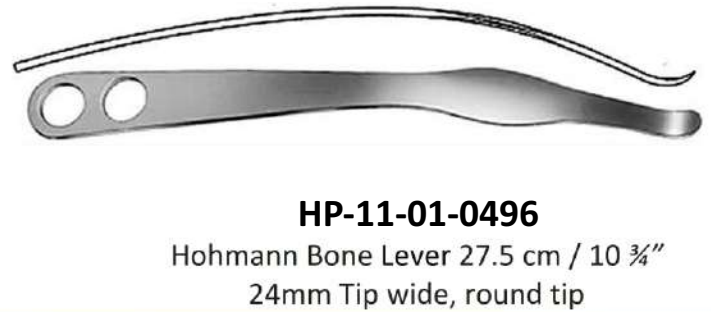
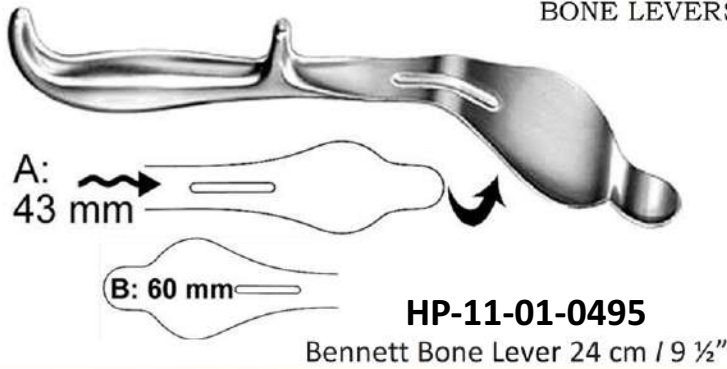

Sizes Available:

- A: 75 X 30 mm
- B: 100 X 30 mm

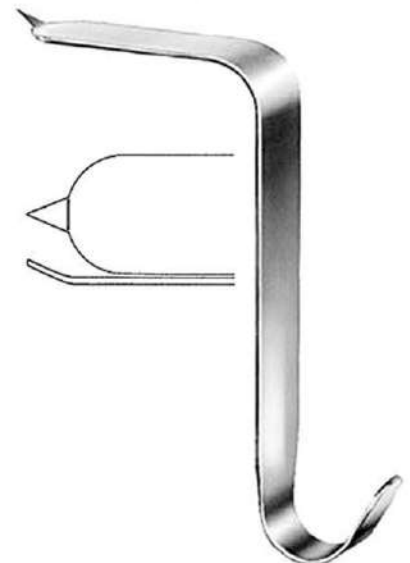

11-01-0503
Taylor Spinal
Retractor
16 cm / 6 1/4"
Pointed end

BONE LEVERS - RETRACTORS

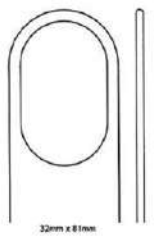

HP-11-01-0504
Fukuda Retractor
19 cm / 7 ½"
T-Handle

A: 32X81mm
B: 38X81mm

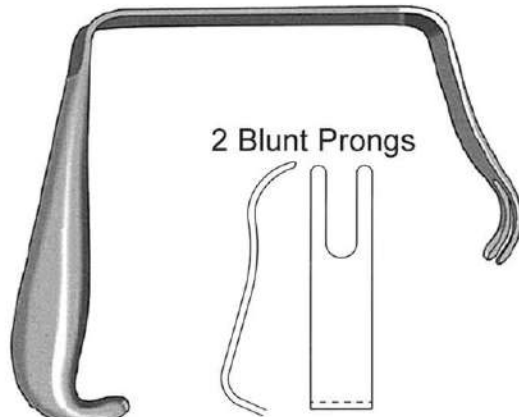

HP-11-01-0505
Bristow / Bankart Humeral Retractor
18 cm / 7"



Medium Blade:
57 / 69mm Deep
11mm Wide

Large Blade:
63 / 76mm Deep
11mm Wide

HP-11-01-0506
Z Knee Retractor 15 cm / 6"



HP-11-01-0507
Deltoid Retractor 28 cm / 11" T Handle w / Ring

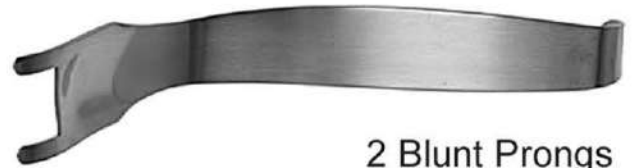

HP-11-01-0508
Humeral Head Retractor 18 cm / 7" Strong Curved

22 mm Blade
1 Sharp Prong

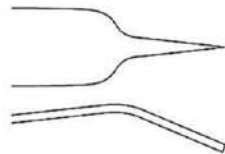

HP-11-01-0509
Capsule Retractor 25 cm / 10"

22 mm Blade
2 Sharp Prong

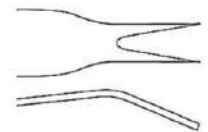

HP-11-01-0510
Capsule Retractor 25 cm / 10"

3 Sharp Prongs

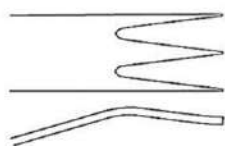

HP-11-01-0511
Capsule Retractor 25 cm / 10"

Soft Tissue Retractor
3 Blunt Prong

22mm
Blade

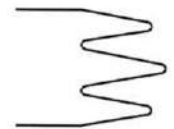

HP-11-01-0512
Bristow / Bankart 19 cm / 7 ½"

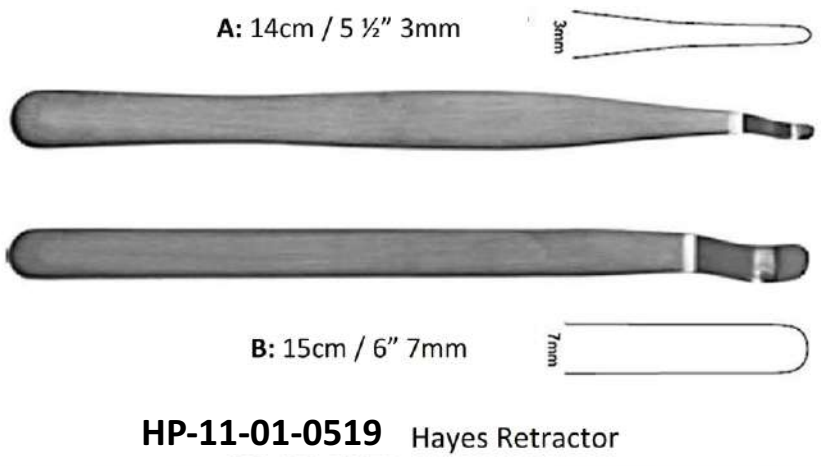
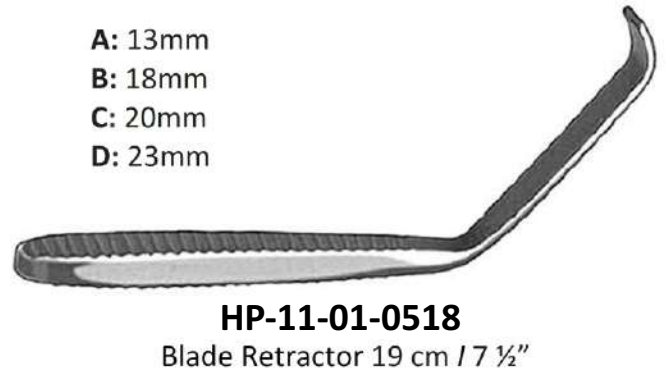
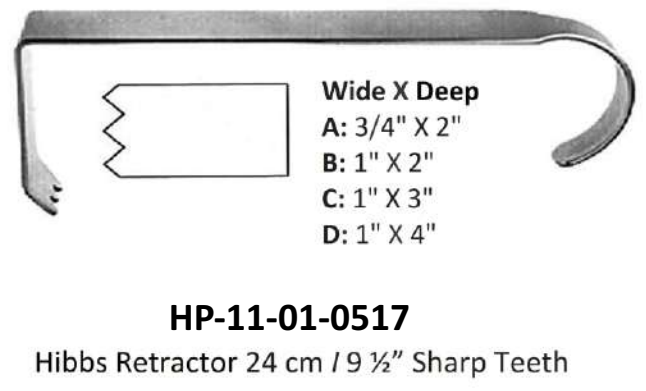
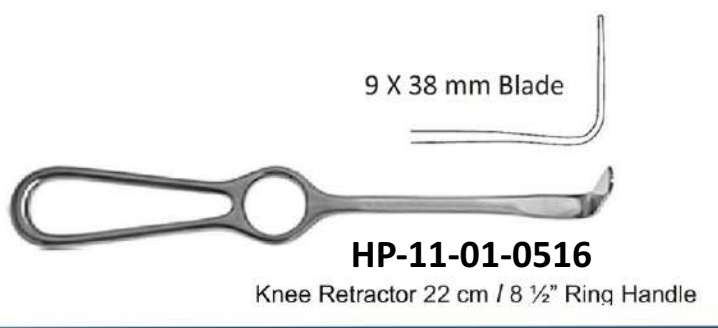
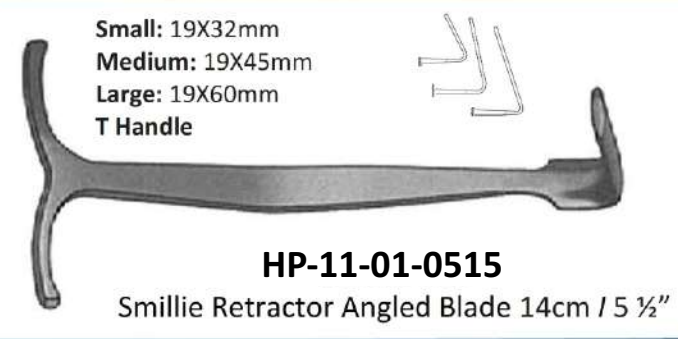
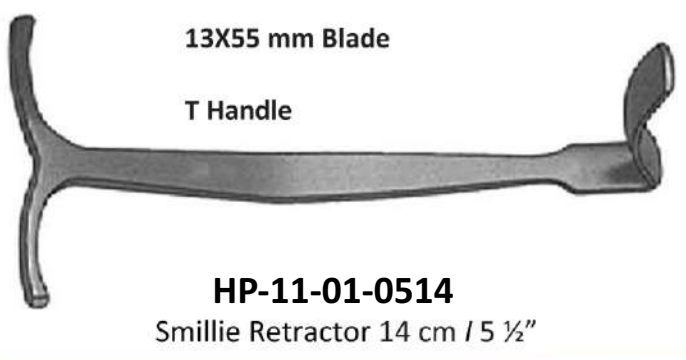
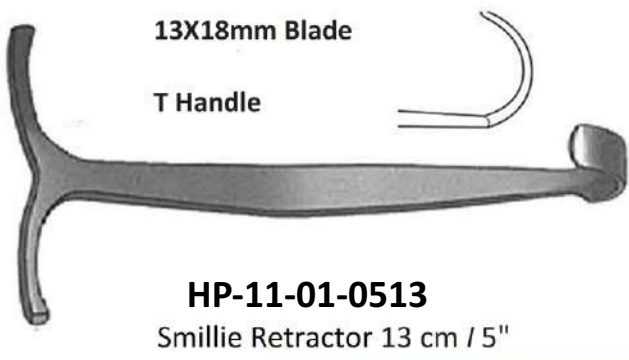

HP-11-01-0520

Mini Hohmann Bone Levers

- A: Blade: 6mm width/35mm drop
- B: Blade: 6mm width/17mm drop
- C: Blade: 8mm width/35mm drop
- D: Blade: 8mm width/17mm drop

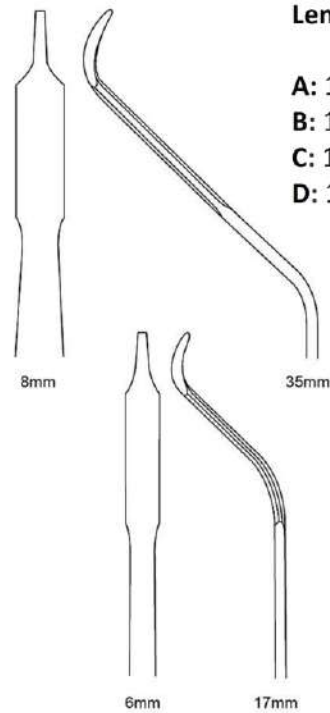
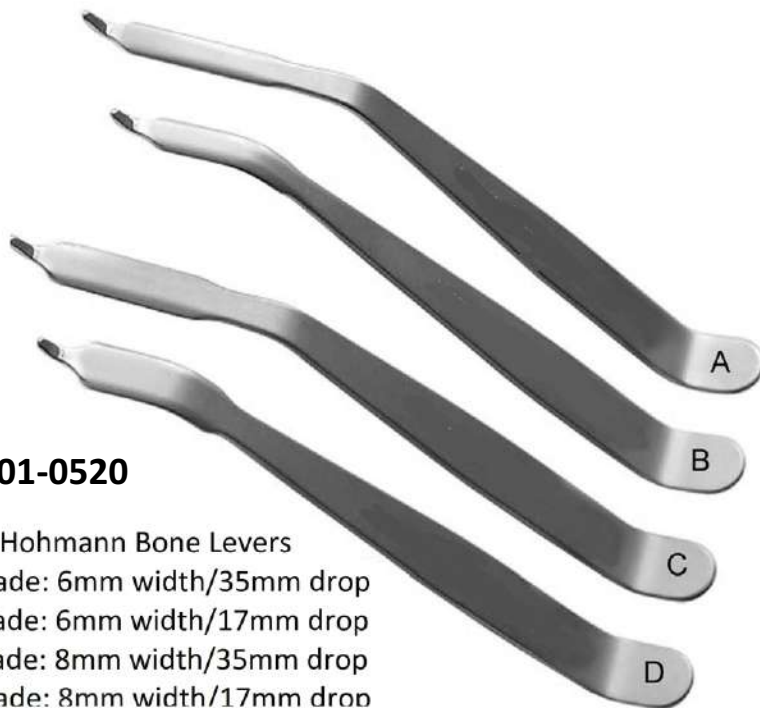

Length:
 A: 15cm / 6"
 B: 15.5cm/6 ¼"
 C: 15cm/6"
 D: 15.5cm/6 ¼"

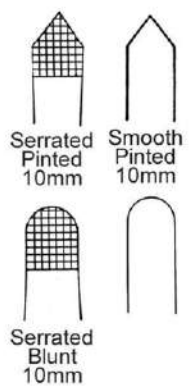
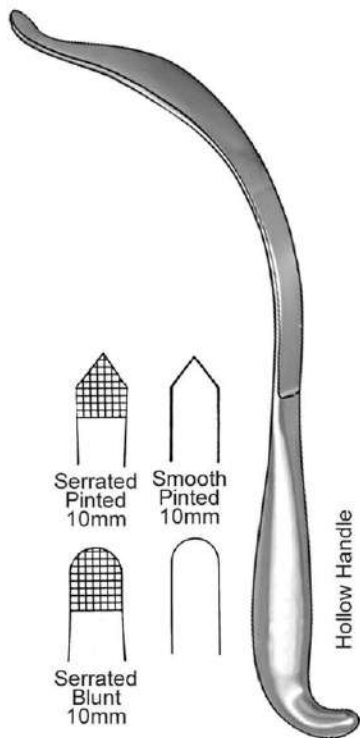

HP-11-01-0521
 Aufranc Cobra Retractor
 26 cm / 10 ½"



Smooth
Blunt
32mm

HP-11-01-0522
 Aufranc Cobra Retractor
 27.5cm / 11"

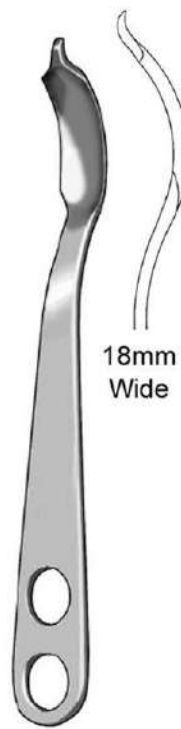

18mm
Wide

HP-11-01-0523
 Humeral Head Retractor
 23 cm / 9"

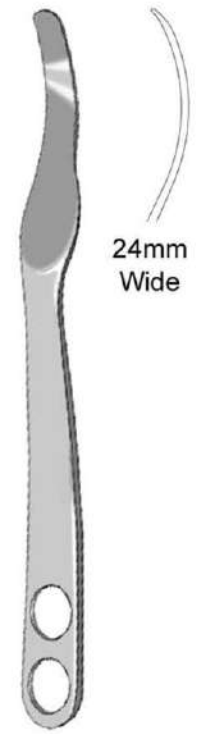

24mm
Wide

HP-11-01-0524
 Pelvic Retractor Single Prong
 26 cm / 10 ¼"

BONE LEVERS - RETRACTORS



HP-11-01-0525

Ribbon Retractor Malleable
30 cm / 12"

AVAILABLE SIZES:

A: 6" X 6mm	G: 8" X 10mm	M: 13" X 38mm
B: 6" X 12mm	H: 8" X 12mm	N: 13" X 45mm
C: 6" X 16mm	I: 8" X 16mm	O: 13" X 50mm
D: 6" X 19mm	J: 8" X 19mm	P: 13" X 65mm
E: 7 1/2" X 25mm	K: 13" X 19mm	Q: 13" X 75mm
F: 8" X 6mm	L: 13" X 30mm	



HP-11-01-0526

Murphy Bone Skid
30 cm / 12"

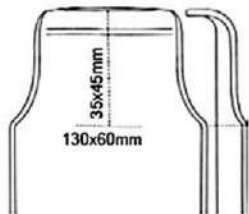

A: 29cm / 11 1/2" With Lip

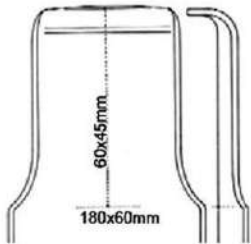

B: 33cm / 13" With Lip

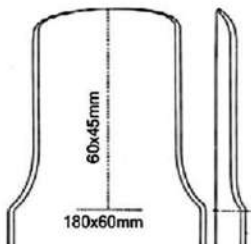

C: 33cm / 13" Without Lip



HP-11-01-0527

St. Mark's Pelvic Retractor
Angled Blade

- A:** 22mm Blade
2 Finger Rings Long Round
- B:** 22mm Blade
1 Finger Ring Short Round

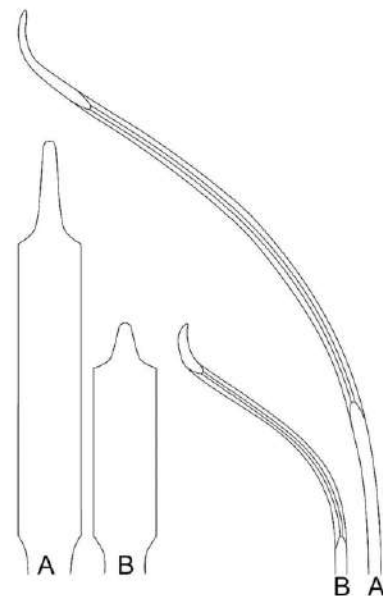
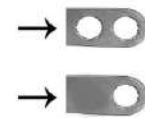

HP-11-01-0528

Hohmann Retractor
40cm / 16"

BONE LEVERS - RETRACTORS

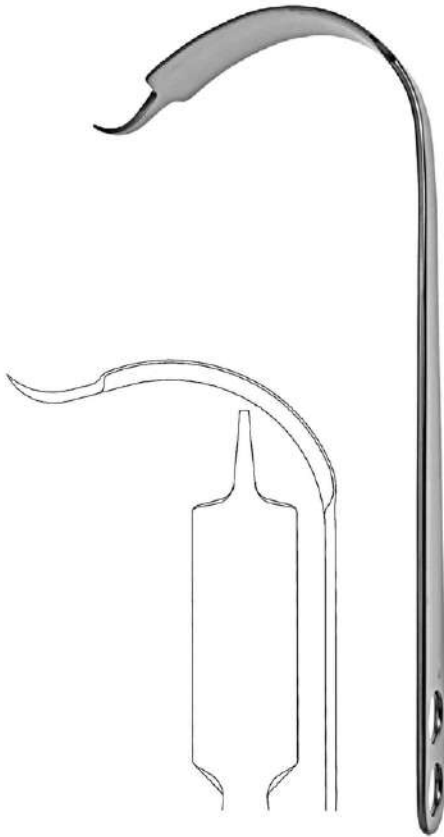

HP-11-01-0529
Hohmann Retractor
33 cm / 13"



HP-11-01-0530
Virchow Skull Breaker
7.5 cm / 3" 40 mm Blade Width

HP-11-01-0531

Buckley Chisel
16cm / 6 1/4"
Octagonal handle



HP-11-01-0532

Buckley Gouge
16cm / 6 1/4"
Octagonal handle

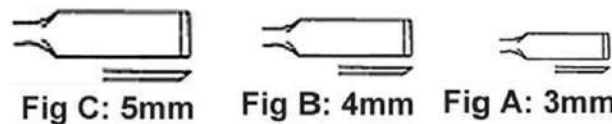
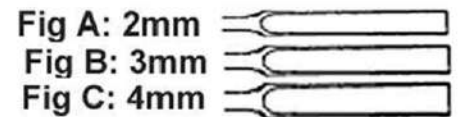

HP-11-01-0533

Stout Bone Chisel 21 cm / 8 1/4" octagonal handle

HP-11-01-0534

Bone Chisel 18 cm / 7" Round Handle

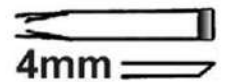

HP-11-01-0535

Bone Chisel 17 cm / 6 3/4" Round Handle

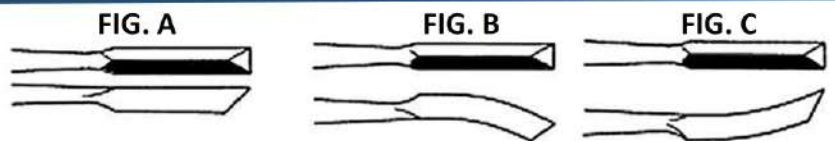
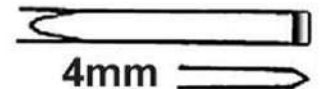

HP-11-01-0536

Gardner Bone Chisel 17 cm / 6 3/4" 4 mm

CHISELS - OSTEOTOMES - GOUGES

FIG A: 3 mm

FIG B: 5 mm



HP-11-01-0537

Snyder-O.S.U Bone Chisel 16.5 cm / 6 1/2" 3 mm / 5 mm

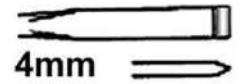

HP-11-01-0538

Bone Chisel 18 cm / 7" Octagonal Handle 4 mm

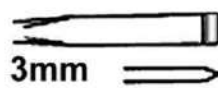

HP-11-01-0539

Bone Chisel 18 cm / 7" Octagonal Handle 3 mm



FIG A



FIG B



HP-11-01-0540

O.S.U. Bone Chisel 17 cm / 6 3/4" 7 mm / 9 mm

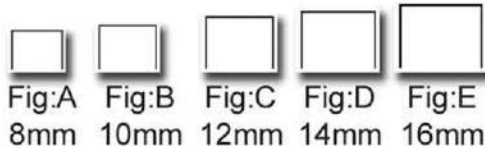
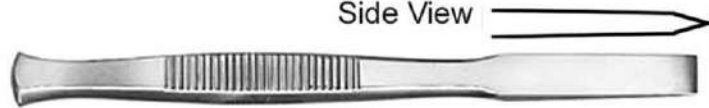

Fig:A 8mm Fig:B 10mm Fig:C 12mm Fig:D 14mm Fig:E 16mm

Side View



HP-11-01-0541

Osteotome 13.5 cm / 5 1/4"

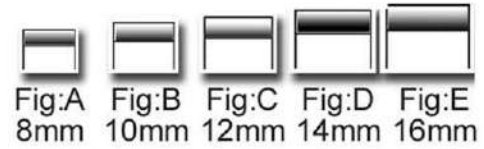
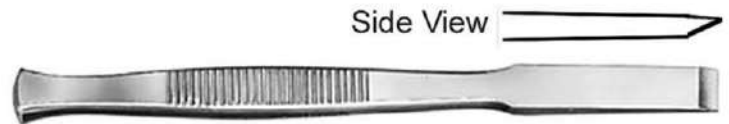

Fig:A 8mm Fig:B 10mm Fig:C 12mm Fig:D 14mm Fig:E 16mm

Side View



HP-11-01-0542

Chisel 13.5 cm / 5 1/4"



Fig:A 8mm Fig:B 10mm Fig:C 12mm Fig:D 14mm Fig:E 16mm

Side View

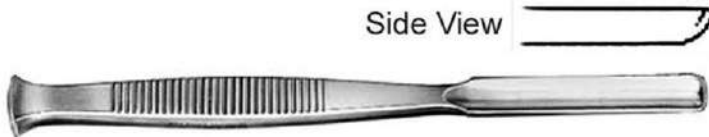

HP-11-01-0543

Gouge 13.5 cm / 5 1/4"

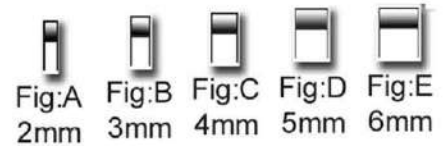
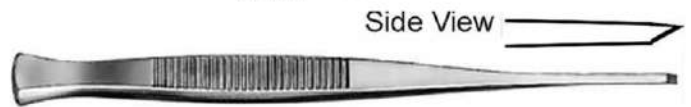

Fig:A 2mm Fig:B 3mm Fig:C 4mm Fig:D 5mm Fig:E 6mm

Side View



HP-11-01-0544 Partsch Chisel 13.5 cm / 5 1/4"

HP-11-01-0545 Partsch Chisel 17 cm / 6 3/4"

CHISELS - OSTEOTOMES - GOUGES

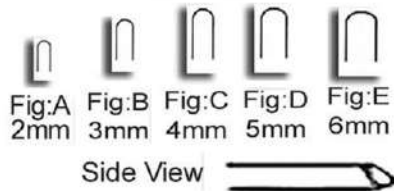

HP-11-01-0546 Partsch Gouge 13.5 cm / 5 ¼"

HP-11-01-0547 Partsch Gouge 13.5 cm / 5 ¼"

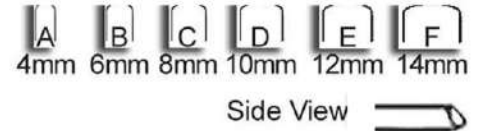

HP-11-01-0548 Alexander Gouge 17.5 cm / 7"

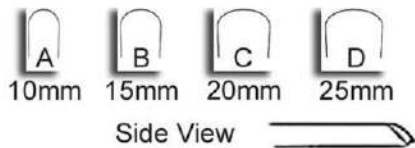

HP-11-01-0549 Stille Gouge 20 cm / 8"

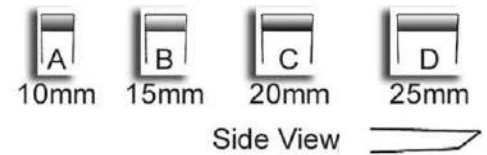

HP-11-01-0550 Stille Chisel 20 cm / 8"

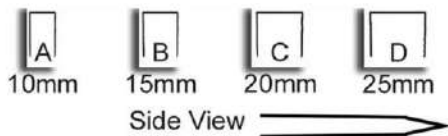

HP-11-01-0551 Stille Osteotome 20 cm / 8"

HP-11-01-0555
Lambotte, Osteotome
24 cm / 9 ½"
Curved Tip



- Available in**
- 15mm
 - 20mm
 - 25mm
 - 30mm
 - 38mm
 - 44mm
 - 50mm

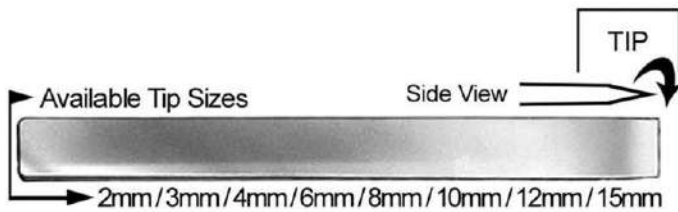

HP-11-01-0552 (12.5 cm / 5") Lambotte, Mini Osteotome

HP-11-01-0553 (17 cm / 6 ¾") Lambotte, Mini Osteotome
3mm / 4mm / 6mm / 8mm / 10mm / 12mm / 15mm

HP-11-01-0554 (24 cm / 9 ½") Lambotte, Osteotome
15mm / 20mm / 25mm / 30mm / 38mm / 44mm / 50mm

CHISELS - OSTEOTOMES - GOUGES

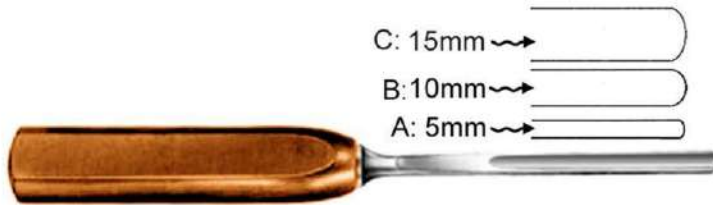

HP-11-01-0556A

Lexers Spongiosa Gouge (25 cm / 9 3/4")

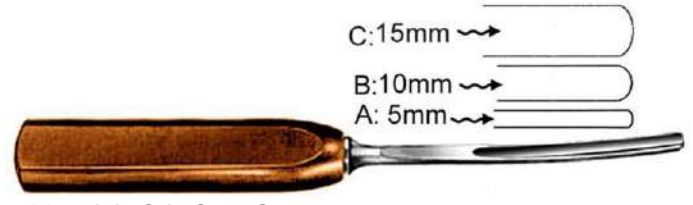

HP-11-01-0556B

Lexers Spongiosa Gouge (25 cm / 9 3/4")

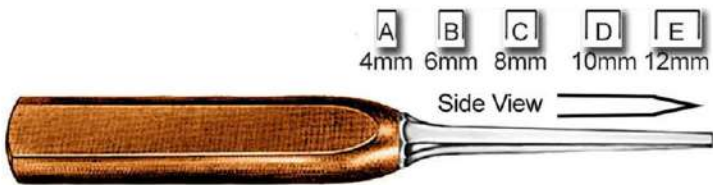

HP-11-01-0557A

Lexers, Mini Osteotome 18.5 cm / 7 1/4"

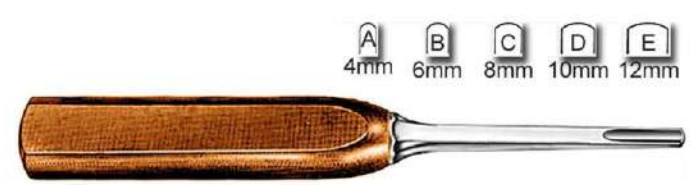

HP-11-01-0557B

Lexers, Mini Osteotome 18.5 cm / 7 1/4"

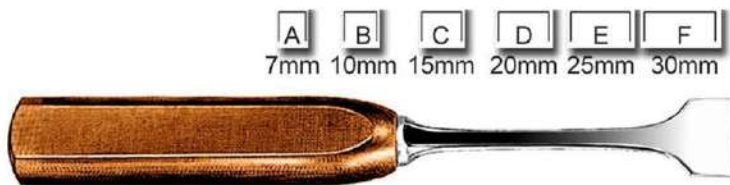

HP-11-01-0558A

Lexers, Osteotome 22 cm / 8 3/4"

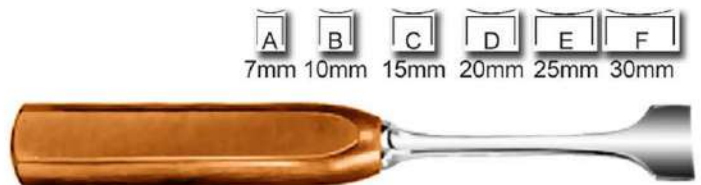

HP-11-01-0558B

Lexers, Osteotome 22 cm / 8 3/4"



HP-11-01-0559

Vickers Spongiosa Gouge 18 cm / 7"

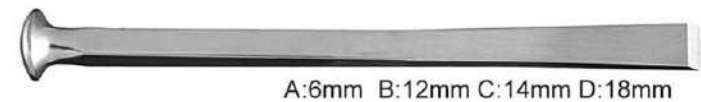

HP-11-01-0560A

US Army Chisel 18 cm / 7"



HP-11-01-0560B

US Army Osteotome 18 cm / 7"



HP-11-01-0560C

US Army Gouge 18 cm / 7"



HP-11-01-0561A

Smith-Petersen Osteotome 20.5 cm / 8" Straight



HP-11-01-0561B

Smith-Petersen Osteotome 20.5 cm / 8" Curved

CHISELS - OSTEOTOMES - GOUGES



HP-11-01-0561C

Smith-Petersen Gouge 20.5 cm / 8" Straight Tip

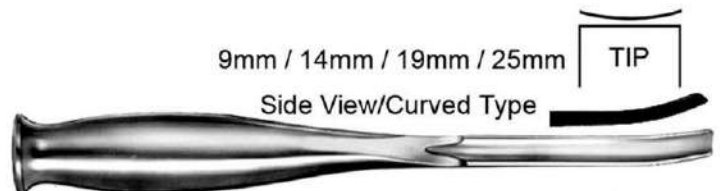

HP-11-01-0561D

Smith-Petersen Gouge 20.5 cm / 8" Curved Tip



HP-11-01-0562

Hook Osteotome 17 cm / 6 3/4"

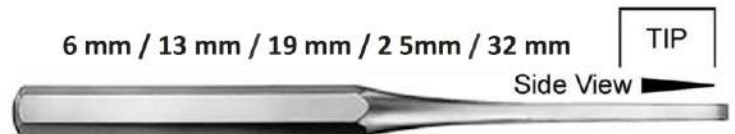

HP-11-01-0563A

Hibbs Osteotome 24.5 cm / 9 3/4"

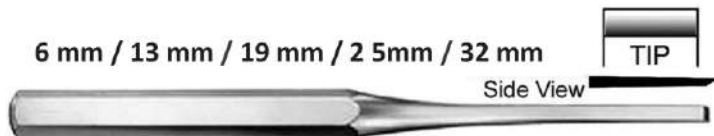

HP-11-01-0563B

Hibbs Chisel 24.5 cm / 9 3/4"



HP-11-01-0563C

Hibbs Gouge 24.5 cm / 9 3/4"

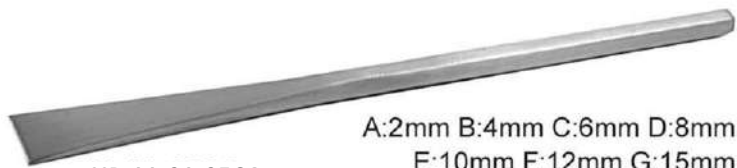

HP-11-01-0564

Sheehan Osteotome 16cm / 6 1/2"



HP-11-01-0565A

Silver Osteotome 18 cm / 7" Straight



HP-11-01-0565B

Silver Osteotome 18 cm / 7" Curved Right



HP-11-01-0565C

Silver Osteotome 18 cm / 7" Curved Left



HP-11-01-0566

Shoulder Penetrating Gouge 21 cm / 8 1/2"

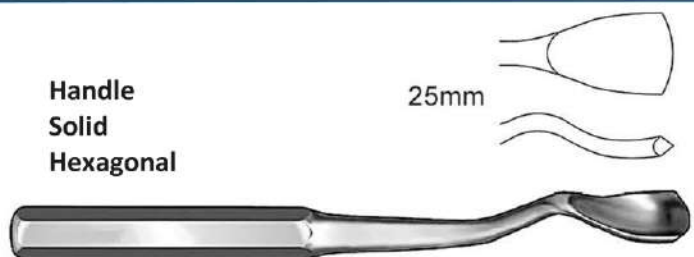

HP-11-01-0567

Swan Neck Gouge 23 cm / 9"

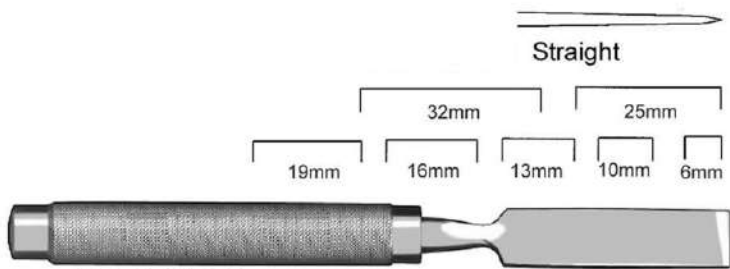

HP-11-01-0568A
Cobb Osteotome 28 cm / 11" Straight

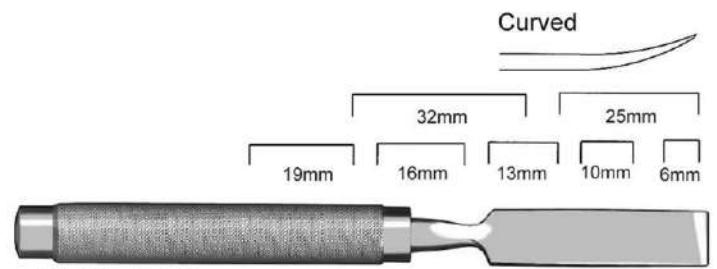

HP-11-01-0568A
Cobb Osteotome 28 cm / 11" Curved

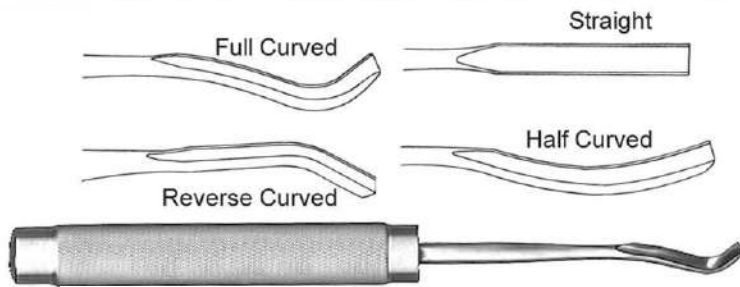

HP-11-01-0569
Cobb Gouge 28 cm / 11"

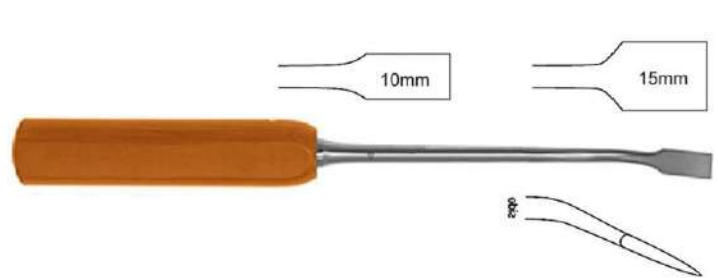

HP-11-01-0570
Lexer Osteotome Angled / 28 cm / 11"

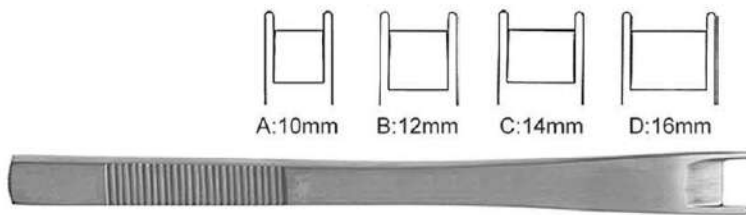

HP-11-01-0571
Cinelli Osteotome 15.5 cm / 6 1/2"

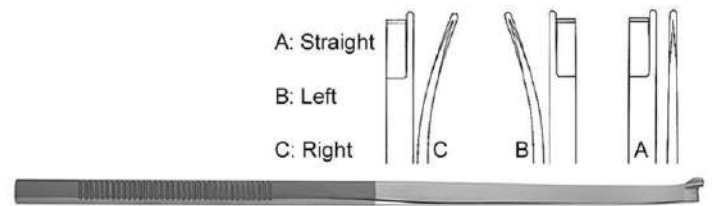

HP-11-01-0572
Anderson Neivert Osteotome 20 cm / 8"

HP-11-01-0573
Hibbs Osteotome 47 cm / 18 1/2" 10 mm Tip
3 1/2" Tip L / 10 3/4" Shaft L / 4 1/4" Handle L
11.5 mm Shaft Diameter

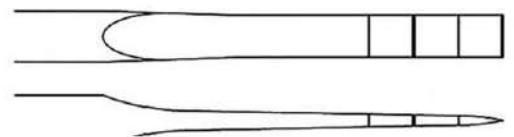

HP-11-01-0574
Hibbs Gouge 47 cm / 18 1/2" 10 mm Tip
3 1/2" Tip L / 10 3/4" Shaft L / 4 1/4" Handle L
11.5 mm Shaft Diameter

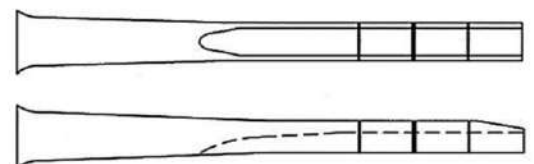

CHISELS - OSTEOTOMES - GOUGES



HP-11-01-0575

Spinal Fusion Gouge 24 cm / 9 1/2" 6 mm Tip

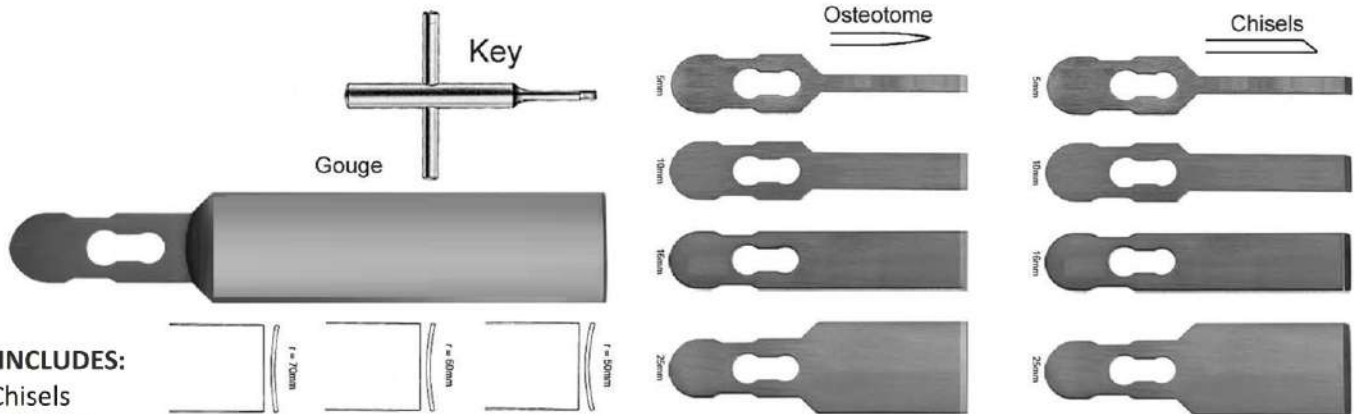

SET INCLUDES:

- 5 x Chisels
- 5/10/15/25mm
- 5 x Osteotomes
- 5/10/15/25mm
- 3 x Gouges
- 50/60/70mm Radius
- 1 x Handle Fibre
- 1 x Key



HP-11-01-0576

Chisel Handle Fibre w/Chisel-Osteotome-Gouge Blades 18.5 cm / 7 1/4"

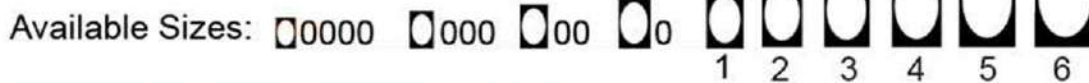

HP-11-01-0577

Volkmann Bone Curette 18.5 cm / 7 1/4" oval with plastic handle

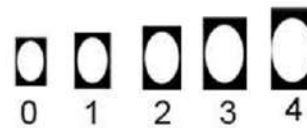

HP-11-01-0578

Volkmann Bone Curette 27.5 cm / 10 3/4" oval with plastic handle

BONE CURETTES

A: 13 cm / 5"
B: 16 cm / 6 ¼"
C: 20 cm / 8"

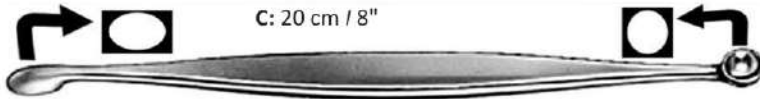

HP-11-01-0579

Volkman Bone Curette, double-ended (oval / round)



HP-11-01-0580

Bone Curette, double-ended (round / oval) 21 cm / 8 ¼"



HP-11-01-0581

Schede Bone Curette 17 cm / 6 ¾" oval with hollow handle

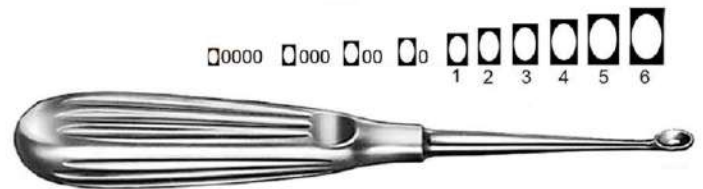

HP-11-01-0582

Volkman Bone Curette 17 cm / 6 ¾" oval, with hollow

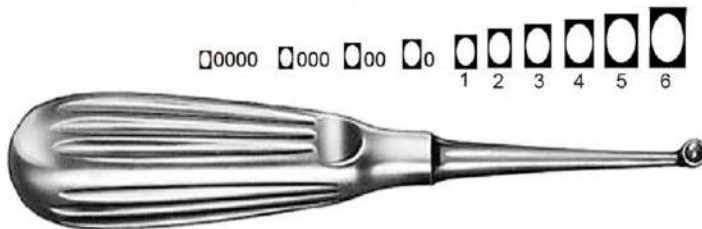

HP-11-01-0583

Bruns Bone Curette 17 cm / 6 ¾" Round, with hollow handle

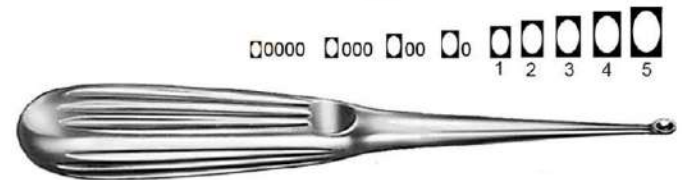

HP-11-01-0584

Spratt Bone Curette 17 cm / 6 ¾" Oval, with hollow handle

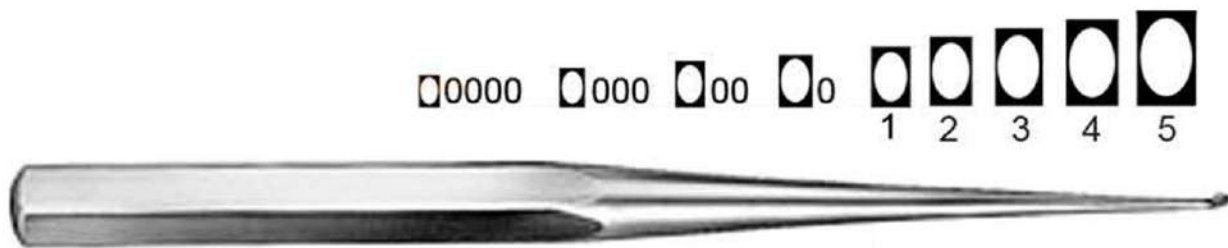

HP-11-01-0585

Bruns Bone Curette 23 cm / 9" oval, solid



HP-11-01-0586

Scoville Bone Curette 25 cm / 9 ¾" oval, with hollow handle

BONE CURETTES



HP-11-01-0587

Simon Bone Curette 25 cm / 9 3/4" oval, with hollow handle



HP-11-01-0588

Modell USA Bone Curette 16 cm / 6 1/4" Oval, with hollow handle



HP-11-01-0589

Modell USA Bone Curette 15.5 cm / 6" Oval, with hollow handle



HP-11-01-0590

Model USA Bone Curette 15.5 cm / 6" Oval, with hollow handle

BONE CURETTES



HP-11-01-0591

Halle Bone Curette 21 cm / 8 ¼" oval, malleable shaft, with hollow handle

A: 00/0 ●/● B: 0/1 ●/● C: 1/2 ●/●

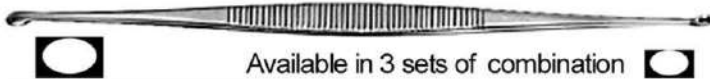

Available in 3 sets of combination

HP-11-01-0592

Williger Bone Curette, double-ended 13.5 cm / 5 ¼" handle



A: 00/00 ●/● B: 0/0 ●/● C: 1/1 ●/●

HP-11-01-0593

Williger Bone Curette, 17 cm / 6 ¾" double-ended oval / oval



A: 12.5 cm / 5"

B: 14.5 cm / 5 ¾"

C: 17 cm / 6 ¾"

HP-11-01-0594

Volkman Bone Curette, double-ended



A: 1 R/L ●/● B: 2 R/L ●/● C: 3 R/L ●/●

HP-11-01-0595

Hemingway-Martin Bone Curette, double-ended

18.5 cm / 7 ¼"



HP-11-01-0596

Bone Curette, 17.5 cm / 7" double-ended round

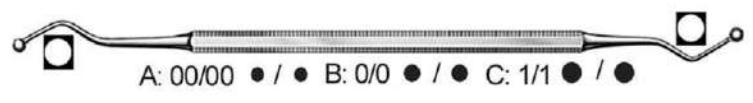

A: 00/00 ●/● B: 0/0 ●/● C: 1/1 ●/●

HP-11-01-0597

Hemingway Bone Curette, double-ended, round / round

18.5 cm / 7 ¼" octagonal handle

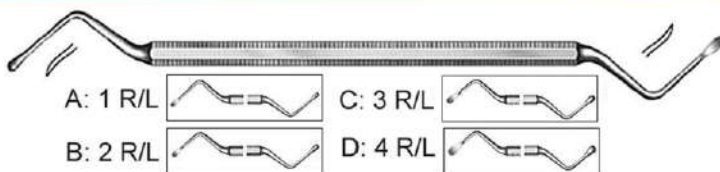

A: 1 R/L

B: 2 R/L

C: 3 R/L

D: 4 R/L

HP-11-01-0598

Lucas Bone Curette, double-ended 18 cm / 7"

Octagonal handle

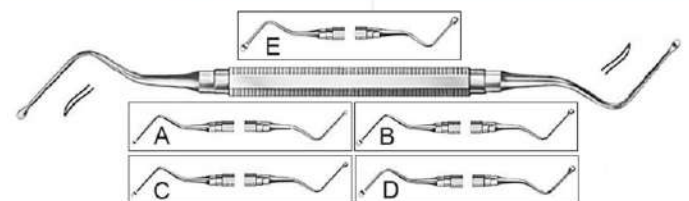

HP-11-01-0699

Miller-Colburn Bone Curette, double-ended 17 cm / 6 ¾"

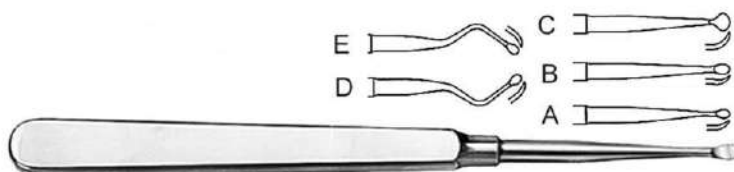

HP-11-01-0600

Molt Bone Curette 17 cm / 6 ¾"

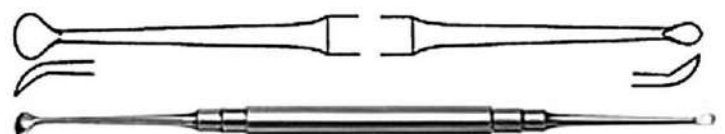

HP-11-01-0601

Molt Bone Curette 19 cm / 7 ½" Round Handle

BONE CURETTES

Hollow Handle
Oval Fenestrated
4X7mm Cup
Sharp/Blunt

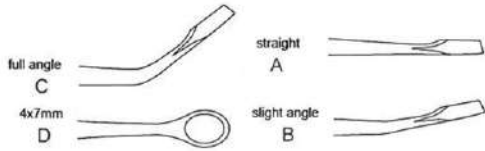

HP-11-01-0602

Semmes Ring Curette 23 cm / 9"

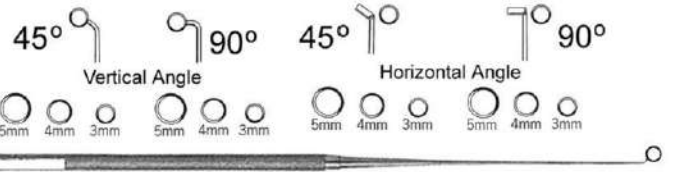

HP-11-01-0603

Ray Pituitary Curette 18 cm / 7 1/2"

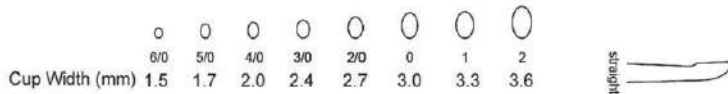

Hollow Handle

Str-Oval Cup

HP-11-01-0604

Lempert Curette 18 cm / 7 1/2"

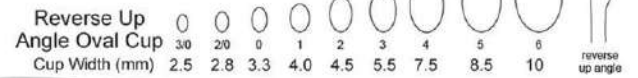

Hollow Handle

HP-11-01-0605

Epstein Curette 18 cm / 7 1/2"

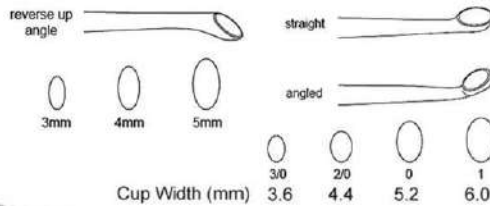

Hollow Handle

HP-11-01-0606

Bushe Curette 25 cm / 10"

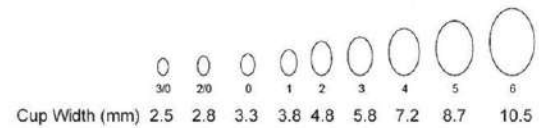

Solid Handle

Str-Oval Cup

HP-11-01-0607

Spinal Fusion Curette 28 cm / 11"

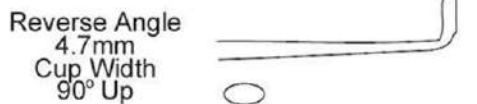

HP-11-01-0608

Scoville Curette 25 cm / 10"

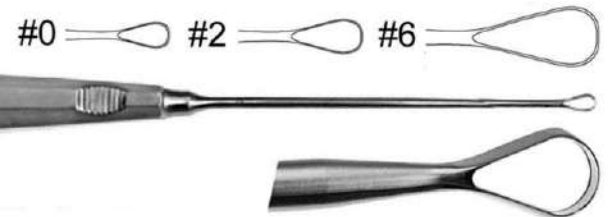

HP-11-01-0609

Ring Curette

- A: 25 cm / 10" #0 6mm Cup
- B: 25 cm / 10" #2 8mm Cup
- C: 26 cm / 10 1/2" #6 14mm Cup
- D: 28 cm / 11 1/2" #0 6mm Cup
- E: 28 cm / 11 1/2" #2 8mm Cup
- F: 30 cm / 12 1/2" #6 14mm Cup

BONE CURETTES

17" Reverse Angled 40° 3mm x 6mm cup
2.7" Tip Length 9.3" Shaft Length 5" Handle
Length .285 (7.2mm) Shaft Diameter

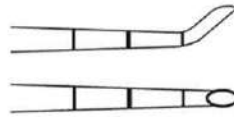

20" Reverse Angled 30°
6mm x 9mm cup 3 1/2"
Tip Length 10" Shaft
Length 6 1/2" Handle
Length .45 (7.2mm)
Shaft Diameter

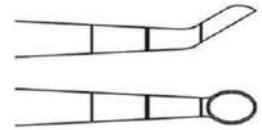

HP-11-01-0616

Epstein Curette Endoscopic Fibre Handle

A: 17cm / 6 3/4" 8mm | B: 19cm / 7 1/2" 16 mm | E: 18.5cm / 7" 12 mm
C: 19cm / 7 1/2" 16 mm | D: 18.5cm / 7 1/4" 12 mm

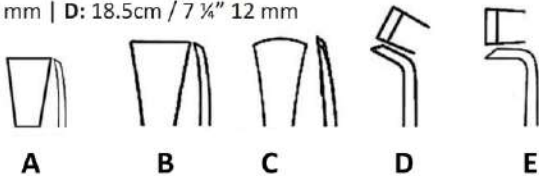

HP-11-01-0617

Martin-Langenbeck Periosteal Elevator (Solid)

B: 18.5cm / 7 1/4" 15mm tip

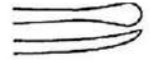
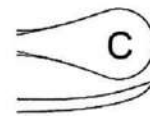

C: 19cm / 7 1/2" 20 mm tip

A: 16cm / 6 1/4" 7mm



HP-11-01-0618

Martin-Langenbeck Periosteal Elevator (Solid)

19.5cm / 7 3/4" C:7mm 4mm tip
6mm tip
19.5cm / 7 3/4" C:6mm 17.5cm / 7" B
7mm tip 5mm tip



HP-11-01-0619

Martin-Langenbeck Periosteal Elevator (Solid)



HP-11-01-0620

Langenbeck Periosteal Elevator 18.5 cm / 7 1/4"
With hollow handle



HP-11-01-0621

Langenbeck Periosteal Elevator 19.5 cm / 7 3/4"
With hollow handle



HP-11-01-0622

Periosteal Elevator 16 cm / 6 1/4" Delicate, solid

PERIOSTEAL ELEVATORS



HP-11-01-0623

Farabeuf Periosteal Elevator 15 cm / 6"
With hollow handle



HP-11-01-0624

Periosteal Elevator 3mm Tip 18 cm / 7"
Extra narrow, with plastic handle

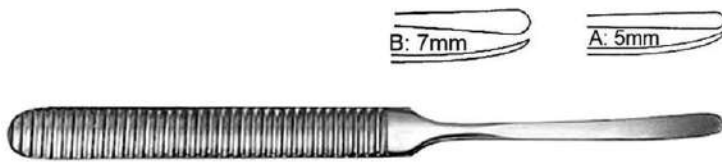

HP-11-01-0625

Kahre-Williger 16 cm / 6 1/4"
Periosteal Elevator solid



HP-11-01-0626

Kahre-Williger Periosteal Elevator solid
16cm / 6 1/4"



HP-11-01-0627

Farabeuf Periosteal Elevator
15 cm / 6" with hollow handle



HP-11-01-0628

Sedillot Periosteal Elevator 22 cm / 8 3/4" (15mm tip)



HP-11-01-0629

Periosteal Elevator 20 cm / 8" (14 mm Tip)
With plastic handle



HP-11-01-0630

Periosteal Elevator 19 cm / 7 1/2"
(14 mm Tip) with plastic handle



HP-11-01-0631

Periosteal Elevator 6mm Tip
18 cm / 7" narrow, plastic handle



HP-11-01-0632

Periosteal Elevator 18 cm / 7" narrow,
Plastic handle (6mm Tip)

PERIOSTEAL ELEVATORS - DISSECTORS



HP-11-01-0633

Williger Periosteal Elevator
12.5 cm / 5" solid 5mm Tip



HP-11-01-0634

Periosteal Elevator,
Double ended 17.5 cm / 7"

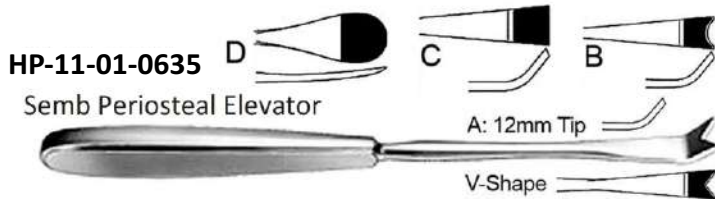

HP-11-01-0635

Semb Periosteal Elevator

A: 12mm Tip

V-Shape

A+D: 21cm / 8 1/4" & B+C: 18.5 cm / 7 1/4"

A: V-shape 12mm | B: Inside round 12mm

C: Straight 13mm | D: Outer round 15mm

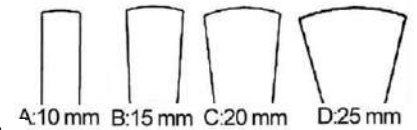

HP-11-01-0636

11-01-0636

Lambotte Periosteal Elevator 21.5 cm / 8 1/2"



HP-11-01-0637

Periosteal Elevator 20 cm / 8" with plastic handle



HP-11-01-0638

Periosteal Elevator 17 cm / 6 3/4" with hollow handle

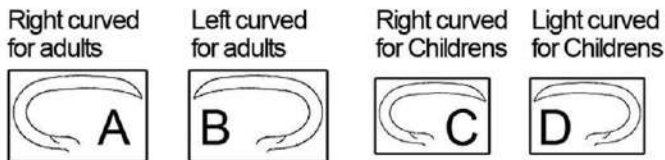

HP-11-01-0639

Doyen Rib Raspatory 17.5 cm / 7" Rib Raspatories with hollow handle

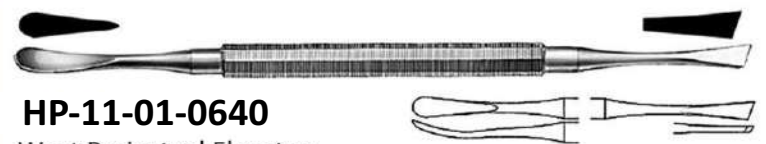

HP-11-01-0640

West Periosteal Elevator,
Double-ended 18.5 cm / 7 1/4" octagonal handle



HP-11-01-0641

Williger Elevator
17 cm / 6 3/4" 7mm tip



HP-11-01-0643

Elevator 17 cm / 6 3/4" Light weight



HP-11-01-0642

Williger Elevator
16 cm / 6 1/4" (5.5mm tip)

PERIOSTEAL ELEVATORS - DISSECTORS

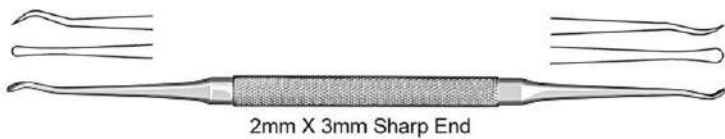

2mm X 3mm Sharp End

HP-11-01-0644

Kleinert Kutz Elevator 14 cm / 5 1/2"



HP-11-01-0645

Vickers Dissector 17 cm / 6 3/4"

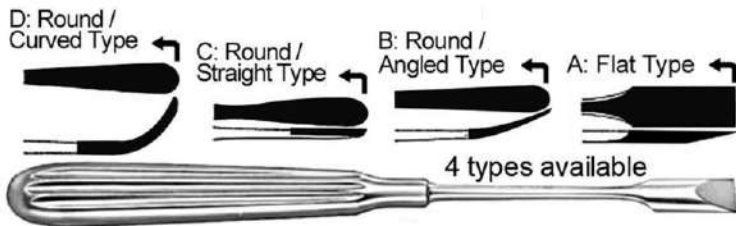

HP-11-01-0646

Adson Elevator 17.5 cm / 7" A/B/C/D

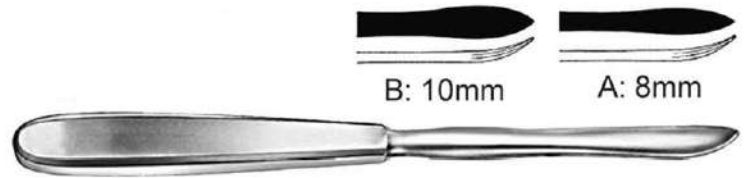

HP-11-01-0647

Langenbeck Elevator 19.5 cm / 7 3/4" A/B

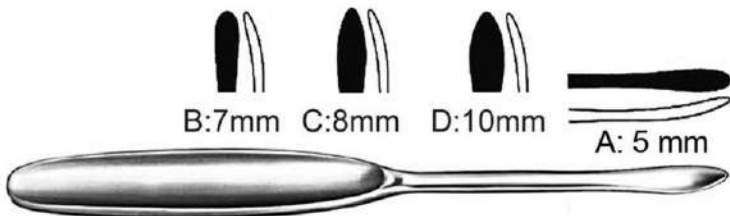

HP-11-01-0648

Martin Langenbeck Elevator 17 cm / 6 3/4" A/B/C | D: 19.5 cm / 7 3/4"



HP-11-01-0649

Phalangeal Elevator 16cm / 6 1/4"



HP-11-01-0650

Alderdyce Dissector, double-ended 21 cm / 8 1/4"



HP-11-01-0651

McDonald Dissector, double-ended 18.5 cm / 7 1/4"



HP-11-01-0652

Freer Elevator 19 cm / 7 1/2"



HP-11-01-0653

Penfield Elevator Endoscopic 38 cm / 15" 5mm Semi Sharp / 1X10mm Blunt Hook



HP-11-01-0654

Smithwick Hook and Dissector 30 cm / 12" 5mm Semi Sharp / 1X10mm Blunt Hook

PERIOSTEAL ELEVATORS - RESPIRATORIES

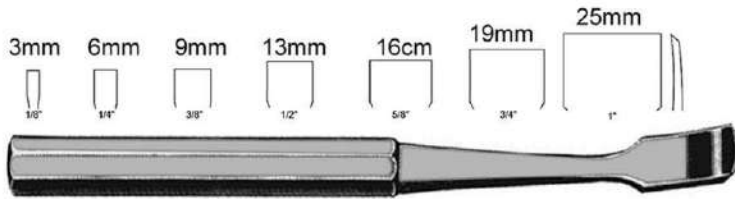

HP-11-01-0655

Key Elevator 19 cm / 7 ½" Sharp Edge

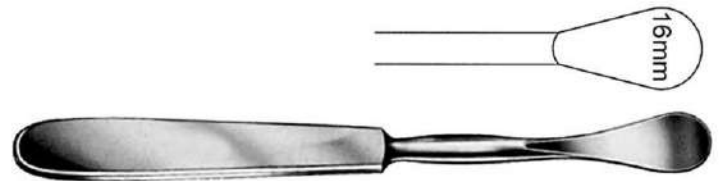

HP-11-01-0656

Sedilot Elevator 18 cm / 7" Sharp Edge



HP-11-01-0657

Alexander Periosteal Respiratory 20 cm / 8" / 12mm Sharp

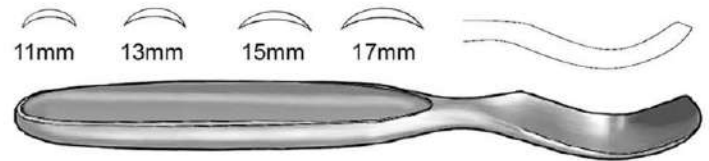

HP-11-01-0658

MeGiamry Metatarsal Elevator 16 cm / 6 ½" Sharp

- A: 19cm / 7 ½" 13mm
- B: 20cm / 8" 19mm
- C: 23cm / 9" 25mm
- D: 25.5cm / 10" 30mm

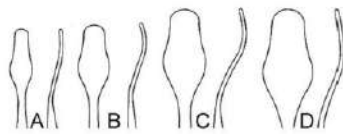

HP-11-01-0659

Chandler Elevator Blunt



HP-11-01-0660

Sayre Elevator 16 cm / 6 ½"
A: Sharp / Blunt B: Blunt/ Blunt

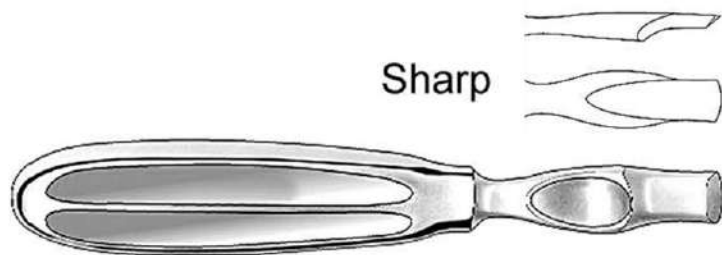

HP-11-01-0661

Kirmission Periosteal Respiratory 17 cm / 6 ¾"

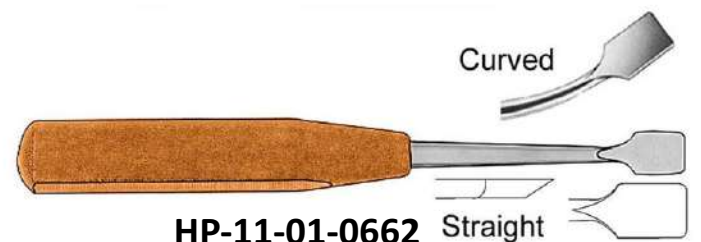

HP-11-01-0662

Periosteal Elevator 17cm / 6 ¾" Fibre Handle
13mm Blade Sharp

- A: 14mm Full Curves
- B: 14mm Slight Curves
- C: 7mm Full Curves
- D: 7mm Slight Curves

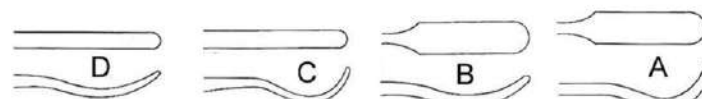

HP-11-01-0663

Crego Periosteal Elevator 19 cm / 7 ¾" Sharp

PERIOSTEAL ELEVATORS - DISSECTORS

Small

A: 26 cm / 10 1/4" 13mm Width at Tip

Medium

B: 26 cm / 10 1/4" 20mm Width at Tip

Large

C: 35 cm / 13 3/4" 25mm Width at Tip

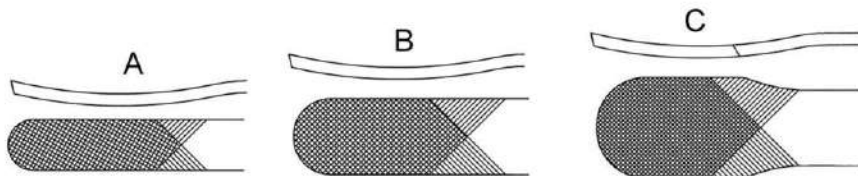

HP-11-01-0664
Darraeh Elevator Blunt

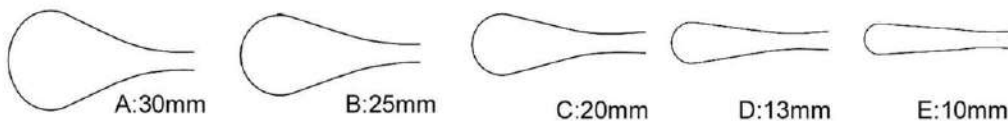

HP-11-01-0665
Cobb Spinal Elevator Sharp 24cm / 9 1/2" Hexa Handle

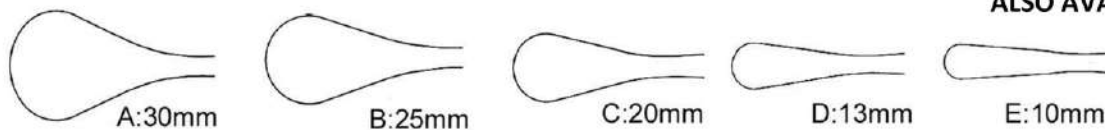

ALSO AVAILABLE WITH FIBRE HANDLE



HP-11-01-0666
Spinal Elevator Sharp 28 cm / 11" Knurled Handle

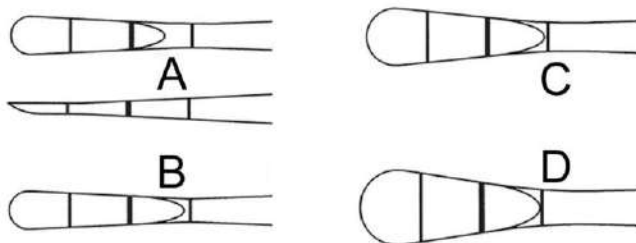

A: 43cm / 17" 6mm Tip Width 2.7" Tip Length 9.3" Shaft Length 5" Handle Length 7.2mm Shaft Dia	B: 50cm / 20" 6mm Tip Width 3 1/2" Tip Length 10" Shaft Length 6 1/2" Handle L 11.5mm Shaft Dia	C: 50cm / 20" 10mm Tip Width 3 1/2" Tip Length 10" Shaft Length 6 1/2" Handle L 11.5mm Shaft Dia	D: 50cm / 20" 13mm Tip Width 3 1/2" Tip Length 10" Shaft Length 6 1/2" Handle L 11.5mm Shaft Dia
--	---	--	--



HP-11-01-0667
Cobb Elevator Endoscopic Sharp / Fibre Handle

ELEVATORS SPINAL – S/S & FIBRE

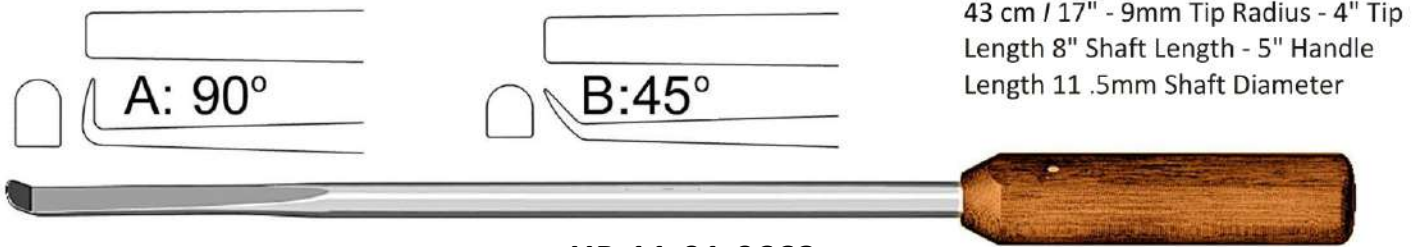

43 cm / 17" - 9mm Tip Radius - 4" Tip Length
8" Shaft Length - 5" Handle Length
11 .5mm Shaft Diameter

HP-11-01-0668

Rib Elevator Endoscopic Sharp / Fibre Handle

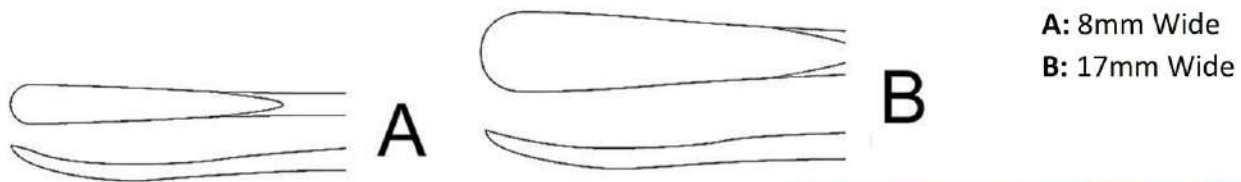

A: 8mm Wide
B: 17mm Wide

HP-11-01-0669

Wagner Elevator Sharp / Fibre Handle 33 cm / 13"



A: 19mm \varnothing / 230 gms
B: 25mm \varnothing / 260 gms

HP-11-01-0670

Lucae Mallet 19.5 cm / 7 3/4"



HP-11-01-0671

Cottle Mallet Plane / Convex
19 cm / 7 1/2" 30mm \varnothing / 300 gms

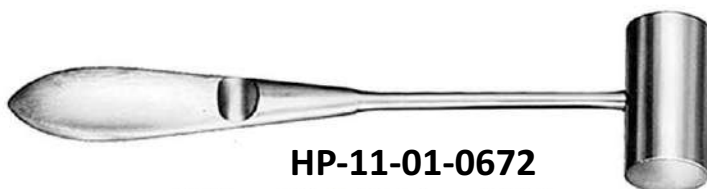

HP-11-01-0672

Williger Mallet 16.4cm / 6 1/2"
20 mm \varnothing / 140 gms



HP-11-01-0673

Mallet 26 cm / 10 1/4"
30 mm \varnothing / 510 gms

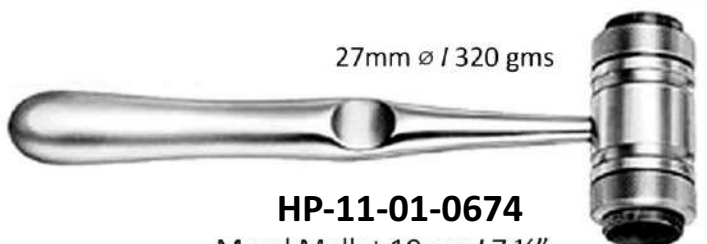

27mm \varnothing / 320 gms

HP-11-01-0674

Mead Mallet 19 cm / 7 1/2"
With interchangeable plastic disks



HP-11-01-0675

Partsch Mallet 19 cm / 7 1/2"
With hollow handle 22mm \varnothing / 200 gms

ORTHOPEDIC MALLETS – S/S & FIBRE



HP-11-01-0676

Mallet 26 cm / 10 ¼" with lead filling
42mm ø / 400 gms



HP-11-01-0677

Mallet 26 cm / 10 ¼" without lead filling
42mm ø / 400 gms

A: 26mm ø / 300 gms
B: 28mm ø / 340 gms
C: 30mm ø / 400 gms



HP-11-01-0678

Williger Mallet 24 cm / 9 ½" lead filled
42mm ø / 400 gms



HP-11-01-0679

Mallet 30 mm ø / 675 gms
26.5 cm / 10 ½" plane (Teflon) / convex (steel)



HP-11-01-0680

Mallet 26 cm / 10 ¼"
42 / 30mm ø / 530 gms



HP-11-01-0681

Mallet 24 cm / 9 ½"
30 mm ø / 480 gms



HP-11-01-0682

Mallet 24 cm / 9 ½"
Disks and handle of Fiber 37 mm ø / 370 gms



HP-11-01-0683

Mallet 22 cm / 8 ¾"
30 mm ø / 125 gms



HP-11-01-0684

Mallet 26.5 cm / 10 ½" | 30 mm ø / 450 gms

A: 20 .5cm / 8" | 25mm ø / 120 gms
B: 21cm / 8 ¼" | 30mm ø / 180 gms
C: 21.5cm / 8 ½" | 35mm ø / 260 gms

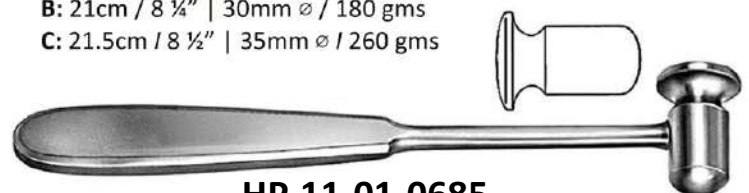

HP-11-01-0685

Doyen Mallet

ELEVATORS SPINAL – S/S & FIBRE



HP-11-01-0686

Herbert Mallet 19 cm / 7 ½"
For ulnar head prosthesis



HP-11-01-0687

Collin Mallet 20 cm / 8"
23 mm ø / 220 gms



HP-11-01-0688

Mallet 26.5 cm / 10 ½"
50 mm ø / 900 gms



Teflon disks

HP-11-01-0689

Vickers Mallet 19 cm / 7 ½"
25 mm ø / 300 gms



HP-11-01-0690

Kirk Mallet 20cm / 8"
Head Dia 38mm / Weight: 1 lb. 4 oz. (570 grams)



Head Weight: 7 oz (200 grams)

HP-11-01-0691

Gerzog Mallet 19 cm / 7 ½"
Head Dia 25mm / Weight 10 oz (285 grams)



Head Weight: 20 oz (567 grams)

HP-11-01-0692

Heath Mallet 19 cm / 7 ½"
Head Dia 40mm / Weight 2 lbs. (907gm)

Head Weight: 20 oz (567 grams)



HP-11-01-0693

Heath Mallet, SS 18 cm / 7" Solid Frame Handle
Head Dia 40mm / Weight 36 oz. (1020gm)

ELEVATORS SPINAL – S/S & FIBRE



HP-11-01-0694

All Fibre Mallet 24 cm / 9 ½"
Head Dia 80X60mm Weight 14oz. (397gm)



Fibre Handle

HP-11-01-0695

Cloward Mallet 19cm / 7 ½"
Head Dia 20mm / Weight 8oz. (227gm)



HP-11-01-0696

Hajek Mallet 20 cm / 8"
Head Dia 27mm / Weight: 7 oz. (198gm)



Fibre Handle

HP-11-01-0697

Narrow Tip Mallet 20cm / 8"
Head Dia 7mm Weight 6oz. (170gm)

B: Head Dia 35mm Weight 11b 40 oz. (570gm)
C: Head Dia 40mm Weight 11b 90 oz. (708gm)



HP-11-01-0698

Fibre Handle Mallet 23cm / 9"
A: Head Dia 30mm / Weight 12 oz. (340gm)



HP-11-01-0699

He-Man Mallet 28cm / 11"
Head Dia 38mm / 24mm / Weight 21b (906gm)

SURGICOSE *Crafted to Excellence*

Heavy Pattern 23 cm / 9" **HP-11-01-0700**

Also available
14.5 cm / 5 3/4"

Heavy Pattern, Short Blades
20 cm / 8" **HP-11-01-0702**

16cm / 6 1/4" Black Plastic Rings

9 1/2" One Serrated Cutting Edge

zaki@surgicose.com / <http://www.surgicose.com>

HP-11-01-0703
Neff Meniscus Knife 22 cm / 8 3/4"

INSTRUMENTS

ORTHOPEDIC DRESSING - PLASTER INSTRUMENTS

11-01-0300 Loren: **HP-11-01-0701** Loren Scissors

11-01-0301 in 10.5 cm / 4 1/4" & 20 cm / 8"

11-01-0302 Bergmann Plaster Shears Heavy Pattern 23.5 cm / 9 1/4"

11-01-0303 Esmarch Plaster Shears

11-01-0304 Bandage Scissors in 18cm / 7 1/2"

11-01-0305 Bruner Plaster Scissors

HP-11-01-0703
Salenius Meniscus Knife 21 cm / 8 1/4" A: Right

HP-11-01-0704
Bunnell Tendon Stripper 15 cm / 6"

HP-11-01-0705
Fischer Tendon Stripper 31 cm / 12 1/4" Blunt

HP-11-01-0706
Tendon Passing Instrument 33.5 cm / 13 1/4"

HP-11-01-0707
Fischer Tendon Stripper 31 cm / 12 1/4" Blunt

HP-11-01-0708
Tendon Stripper 3 / 4 / 5 / 6mm
A: 28.5 cm / 11 1/4" B: 60 cm / 24"

HP-11-01-0709
Bunnell Tendon Passer 23 cm / 9" Malleable

HP-11-01-0710
Downing Cartilage Knife 25 cm / 10"
Concave Edge Cvd Blade w/ Guards

HP-11-01-0711
Low Breck Cartilage Knife 25cm/10" STR Edge-Cvd Blade w / Guards

HP-11-01-0712
Tendon Stripper 40 cm / 16" Fibre Handle

Orthopedic Instruments Catalogue

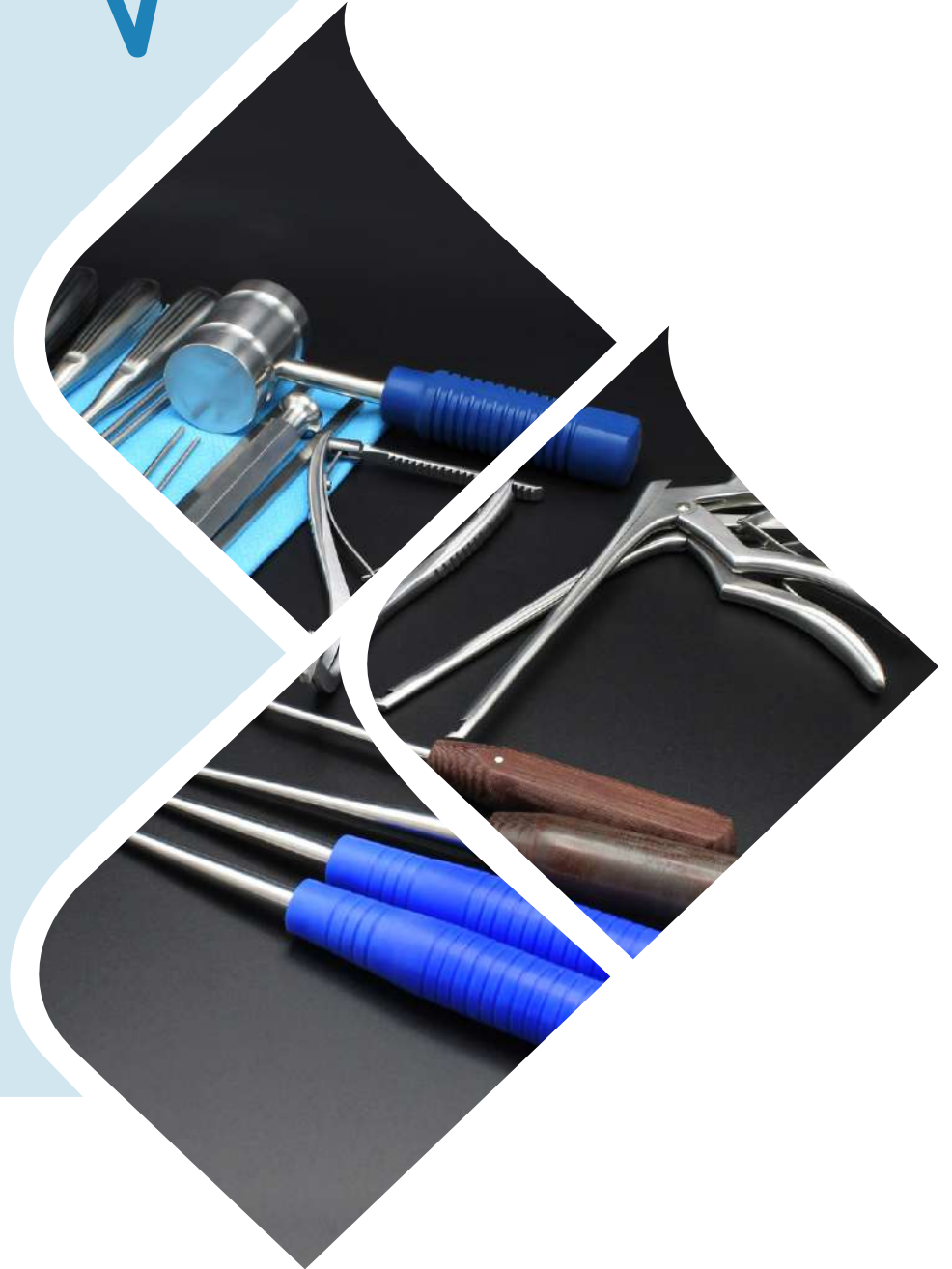

 MuradPur New Abadi, Near Police Station, Sialkot - 51310 Pakistan

 +92 (326) 877 8787

 info@healproinstruments.com | healprohealthproduct@gmail.com

 www.healproinstruments.com

