

# ENT

*Instruments Catalogue*





## About Us

**HEALPRO INSTRUMENTS** was established and Oldest manufacturer and exporter of vast rang of Instruments. It comprises of an integrated manufacturing facility, employing skilled craftsmen to produce broad range of professional Instruments. Its manufacturing process is running under the supervision of expert technicians.

### Management

Skilled employees are its main source for innovation and development of new products. They are working in safe and open environment where every worker contributes continuously to expand the company business. Qualified persons are hired to make use of the progressive technology. The company is also providing active support to its employees to improve their skills, creativity power and social development.

### Our Aim

**HEALPRO INSTRUMENTS** & Company has earned the credit to get the entire satisfaction of the customers. By providing

Quality Products  
Fair Prices  
Timely Deliveries  
Product Range

**HEALPRO INSTRUMENTS** produces different types of Instruments. Our Main line of the business is General Surgical Instruments, Dental, Plastic Surgery Instruments, ENT Instruments, Gynecology & Ophthalmic Instruments. Each Instrument manufactured by

**HEALPRO INSTRUMENTS** has personally been supervised and monitored to make sure that the Instruments are perfect. In other words, continuous research and development has allowed this company to make superior quality products.

### Quality Standards

**HEALPRO INSTRUMENTS** has achieved the certification of Sialkot Chamber of Commerce, Surgical Instruments Manufacturer Association Of Pakistan, NTN, CE Mark, ISO 13485-2016. These quality assurance standards are maintained throughout the different production process by its modern testing devices and trained staff which is the main hallmark to maintain the quality of its products.

**HEALPRO INSTRUMENTS**

**C.E.O**



# ENT

## INSTRUMENTS CATALOGUE

## Otology

- Ear Polypus Forceps
- Ear Syringes
- Micro Ear Forceps
- Micro Ear Scissors
- Micro Ear Knives
- Micro Ear Hooks
- Micro Ear Needles
- Micro Ear Curettes
- Micro Ear Speculas
- Mastoid Rongeurs
- Tuning Forks

**BLACK COATED**

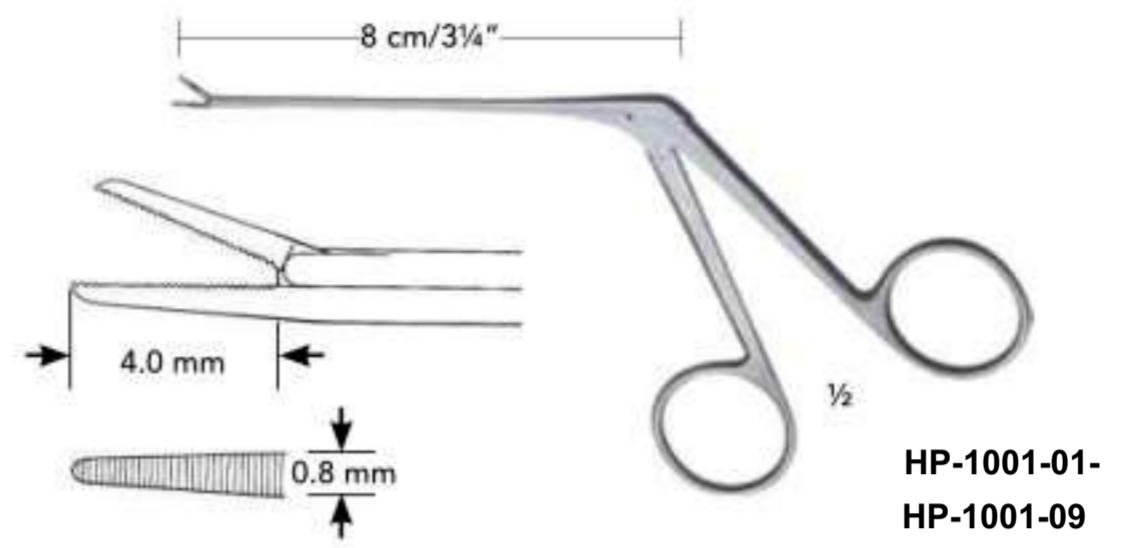
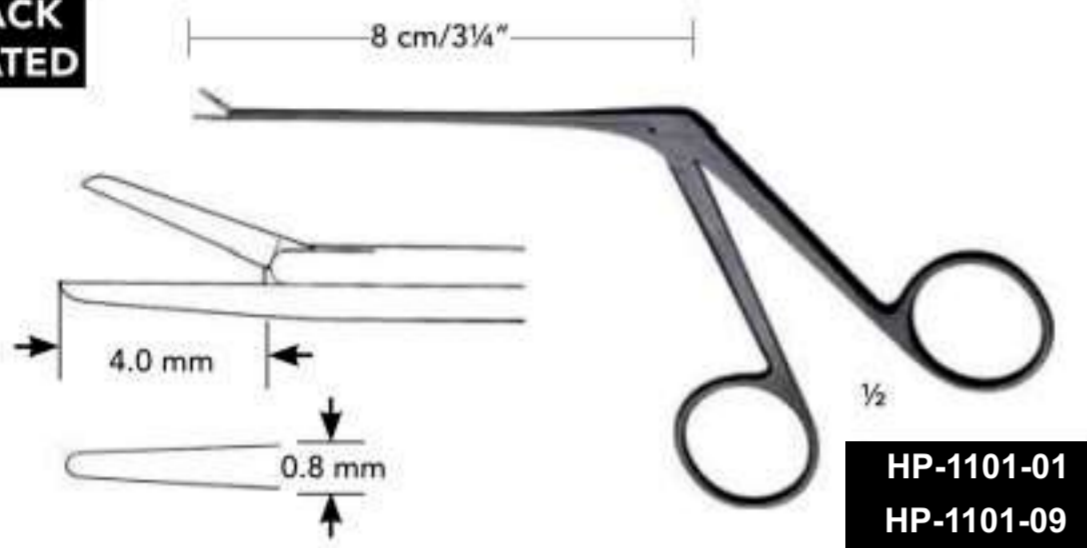

Straight, smooth



HP-1001-01  
HP-1101-01

Straight, serrated



HP-1001-06  
HP-1101-06

Bent upwards, serrated



HP-1001-07  
HP-1101-07

Right, serrated



HP-1001-08  
HP-1101-08

Left, serrated



HP-1001-09  
HP-1101-09

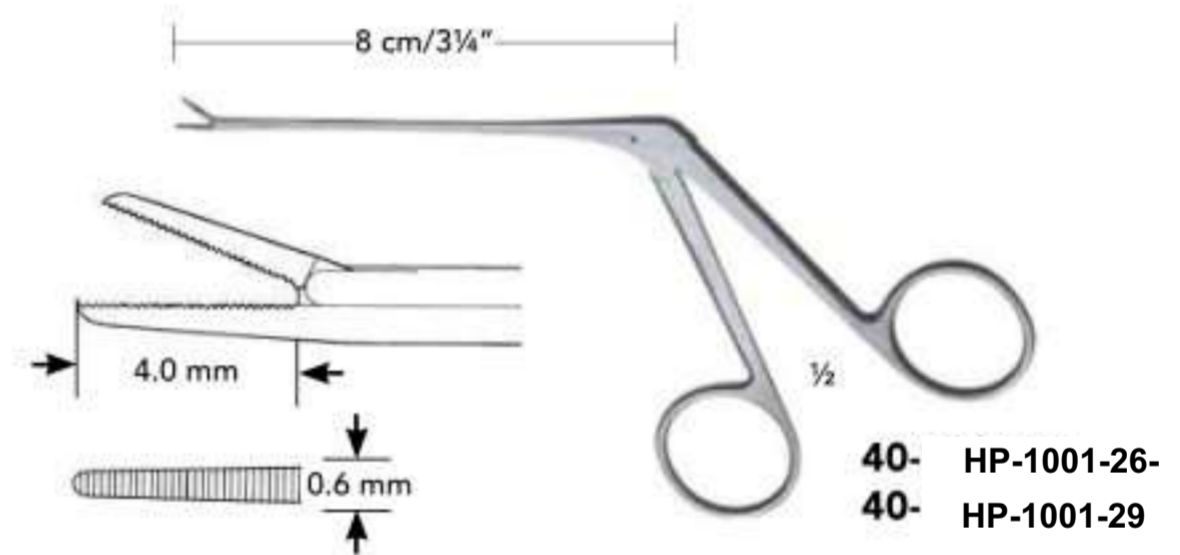
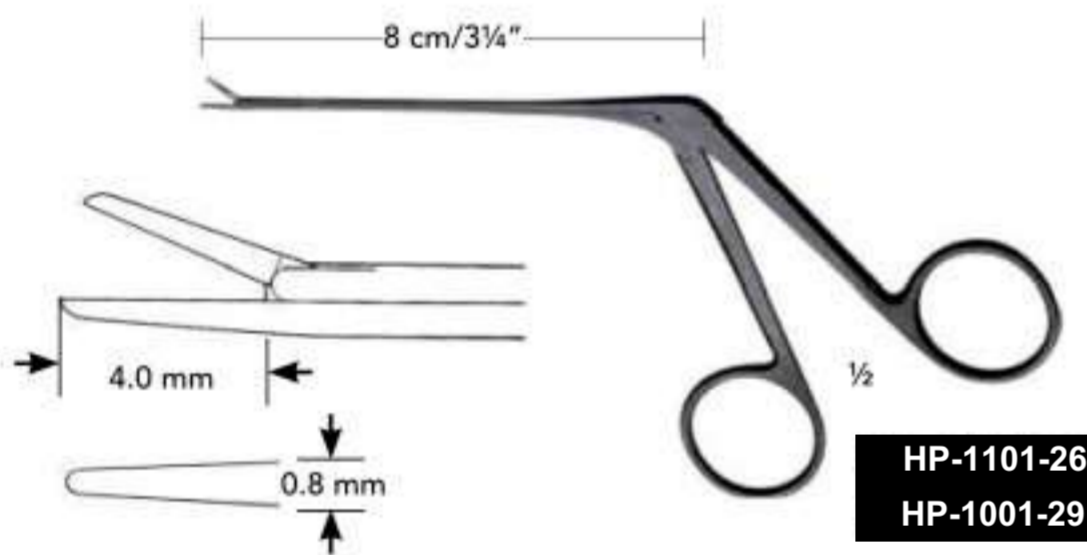

Straight, smooth



HP-1001-26  
HP-1101-26

Upwards, serrated



HP-1001-27  
HP-1101-27

Right, serrated



HP-1001-28  
HP-1101-28

Left, serrated



HP-1001-29  
HP-1101-29

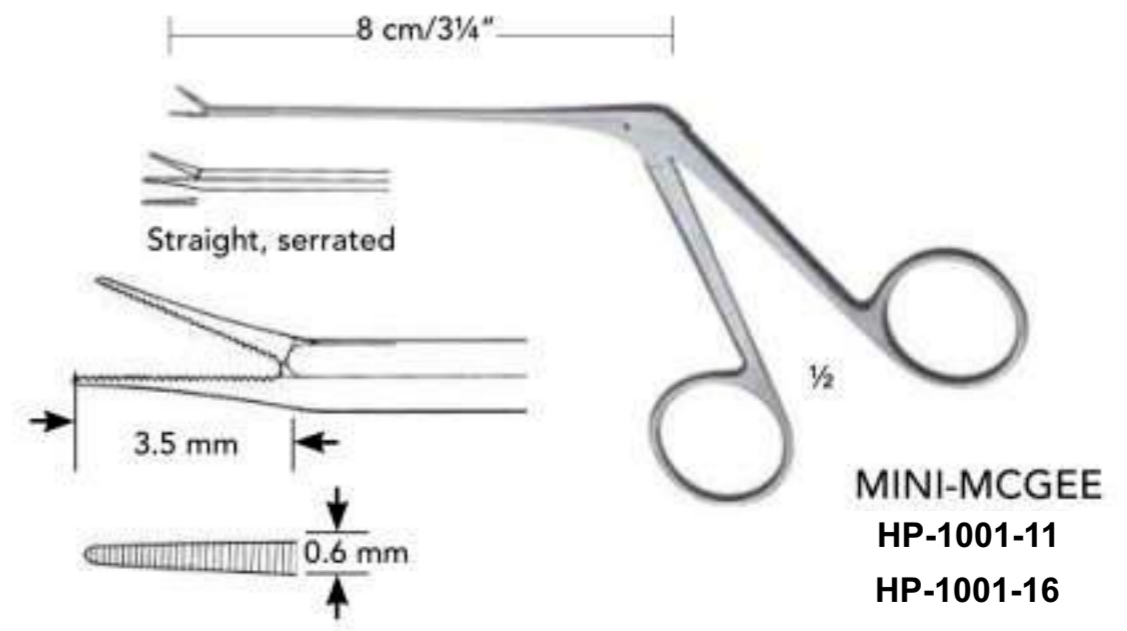
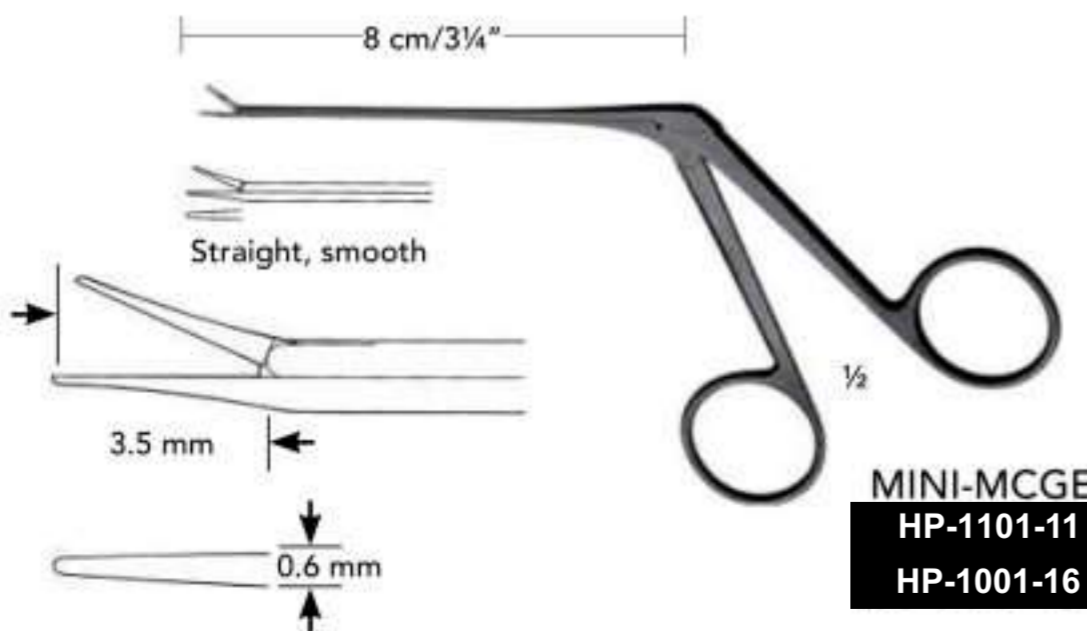

Straight, smooth



HP-1101-11  
HP-1001-16

Straight, serrated



HP-1001-11  
HP-1001-16

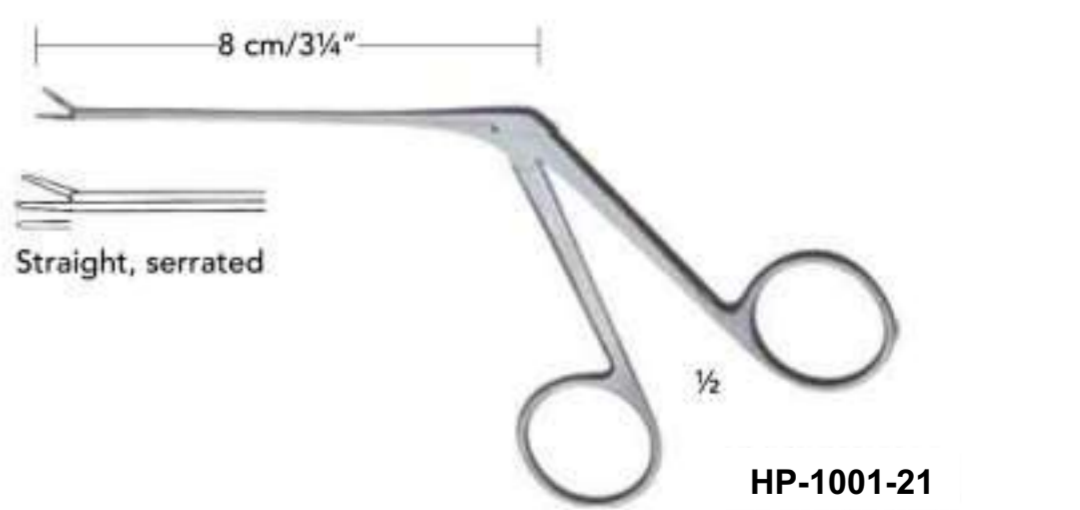
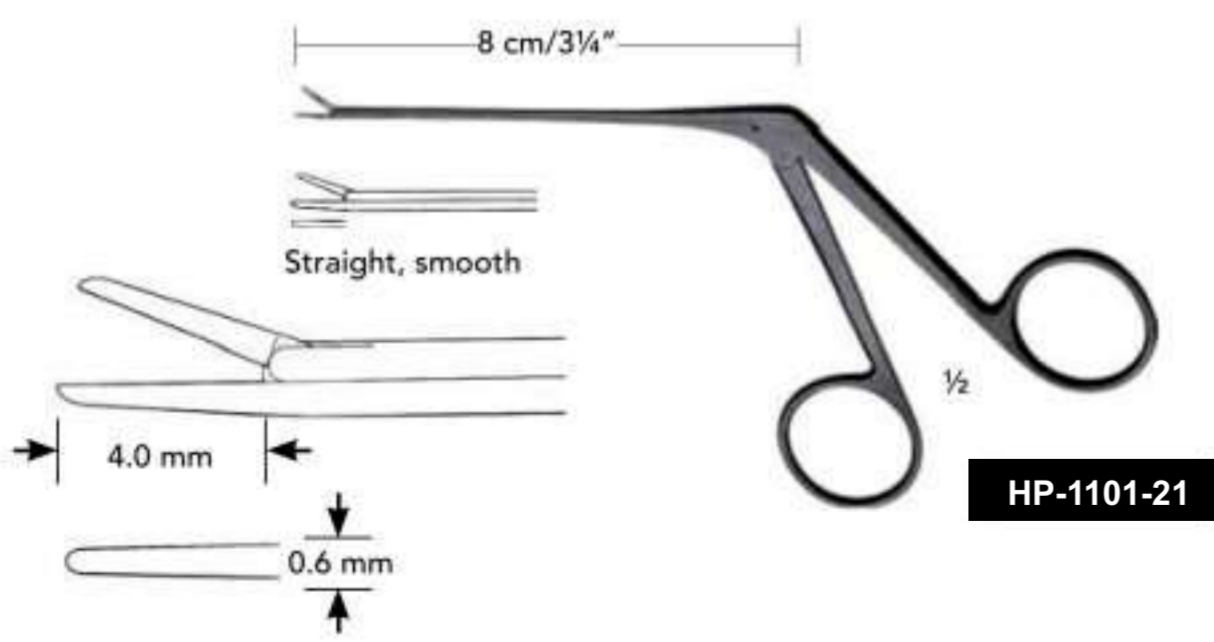
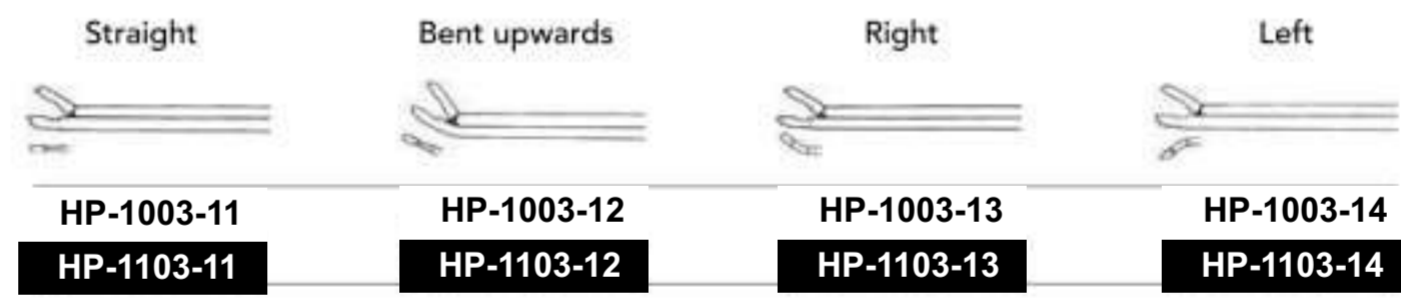
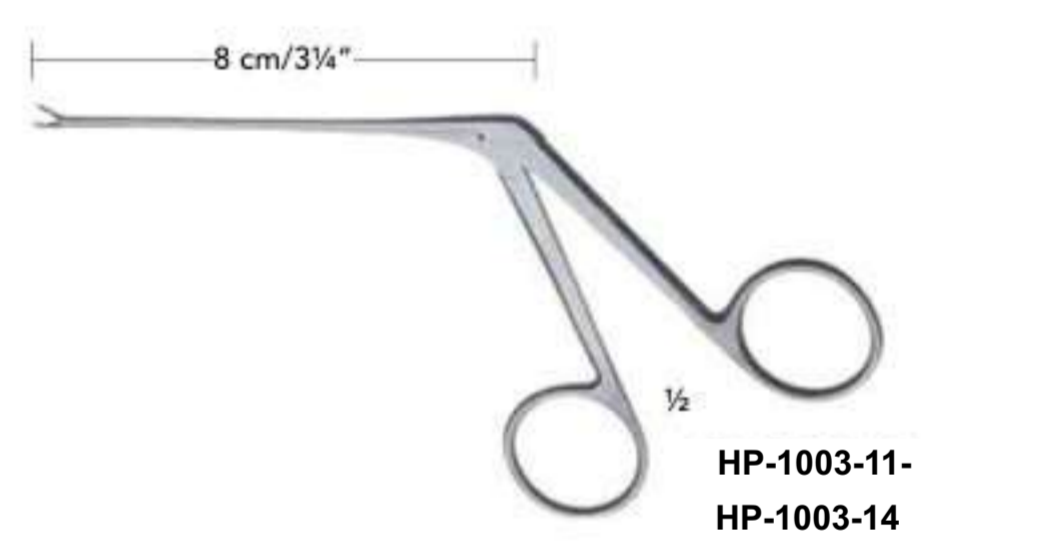
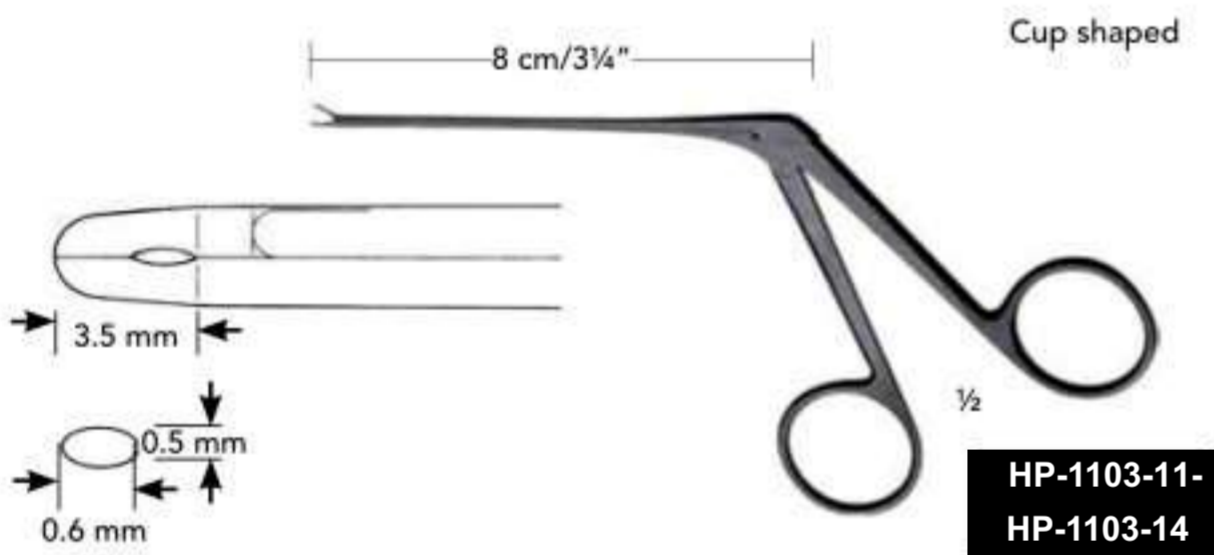
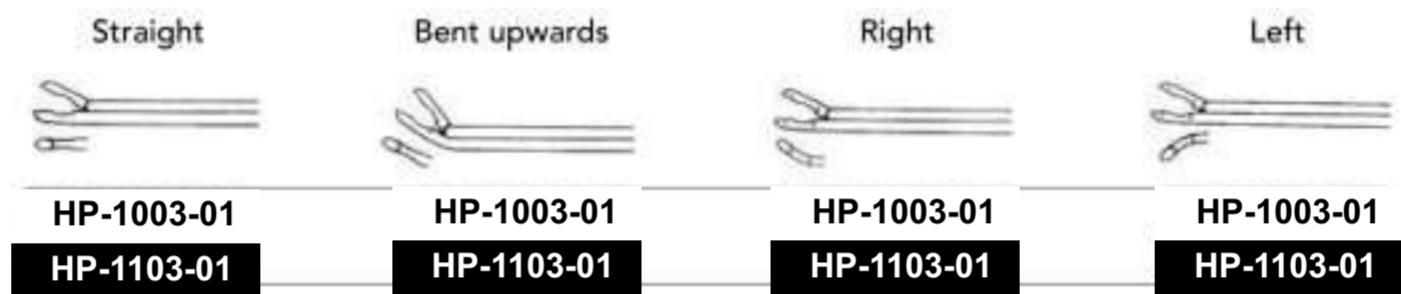
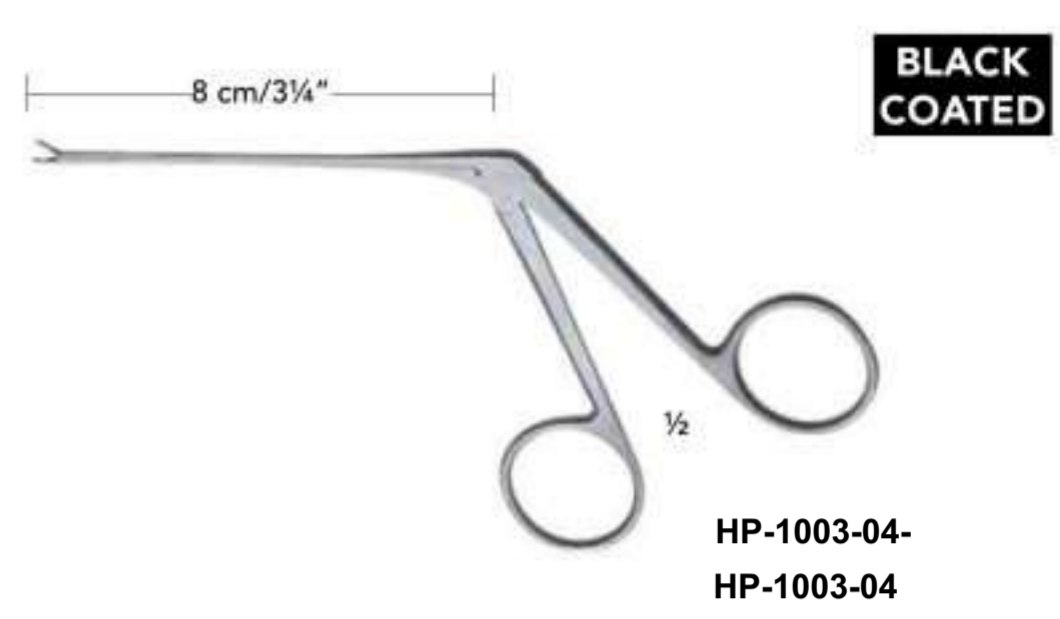
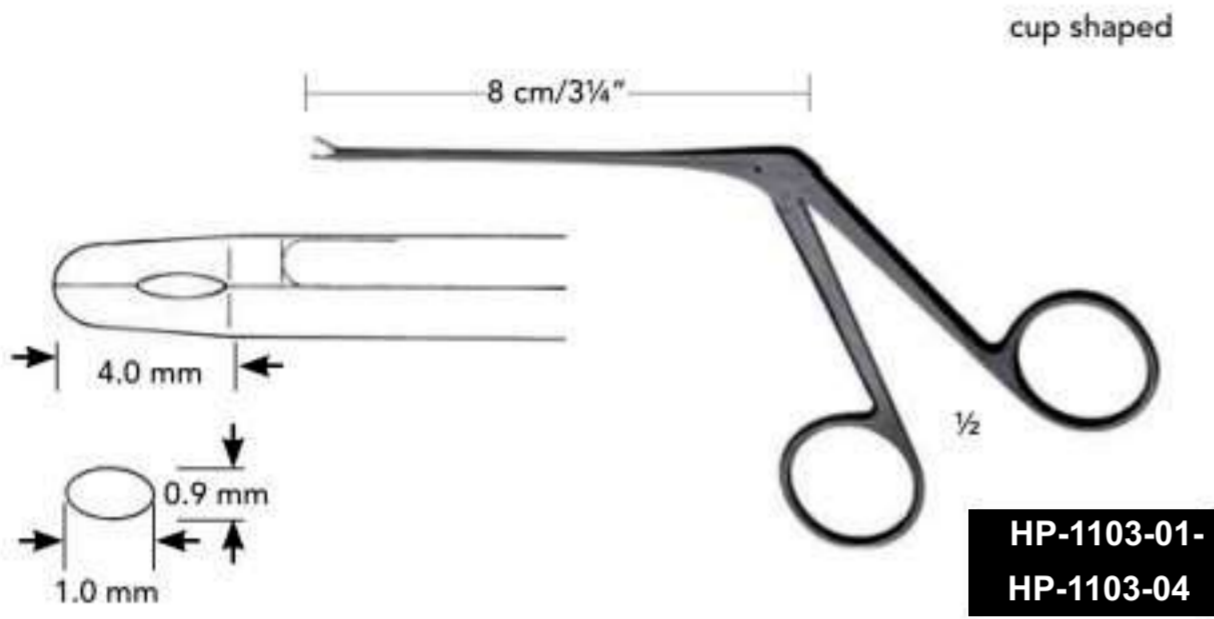

**BLACK COATED**

Wire bending forceps

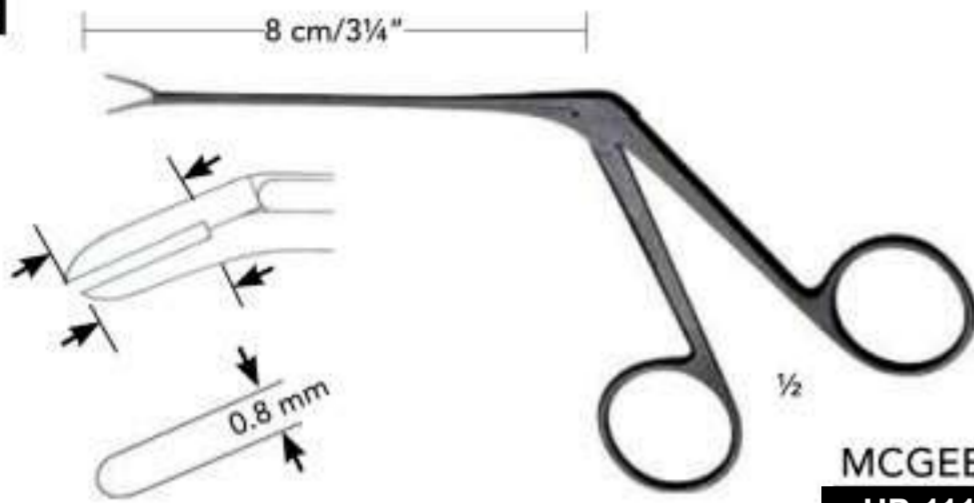

MCGEE  
HP-1110-11-  
HP-1101-12

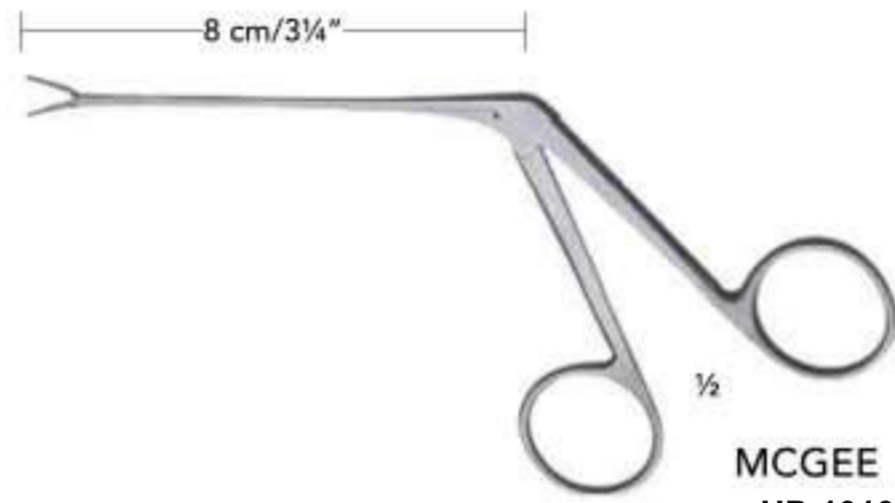

MCGEE  
HP-1010-11-  
HP-1010-12

Angled downward



0.8 x 3.5 mm  
HP-1010-11  
HP-1110-11

Angled downward



0.8 x 6.0 mm  
HP-1010-12  
HP-1110-12

Malleus nipper

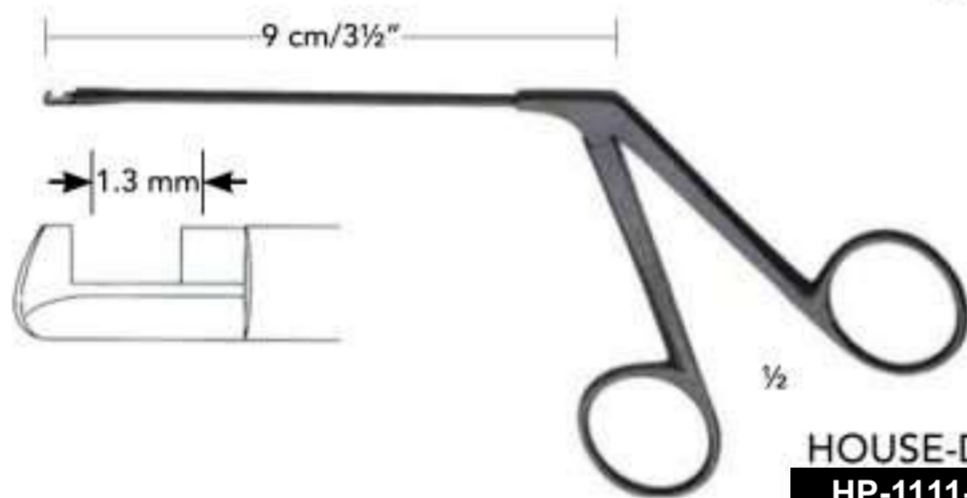

HOUSE-DIETER  
HP-1111-11-  
HP-1111-07

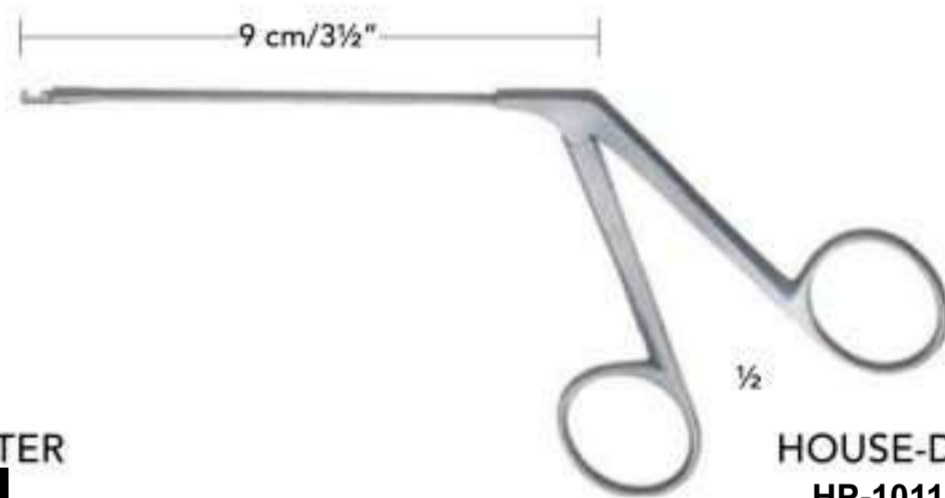

HOUSE-DIETER  
HP-1011-01-  
HP-1011-07

Up cutting



HP-1011-01  
HP-1111-01

Down cutting



HP-1011-02  
HP-1111-02

Right cutting



HP-1011-06  
HP-1111-06

Left cutting



HP-1011-07  
HP-1111-07

Introducing Forceps, for teflon prosthesis

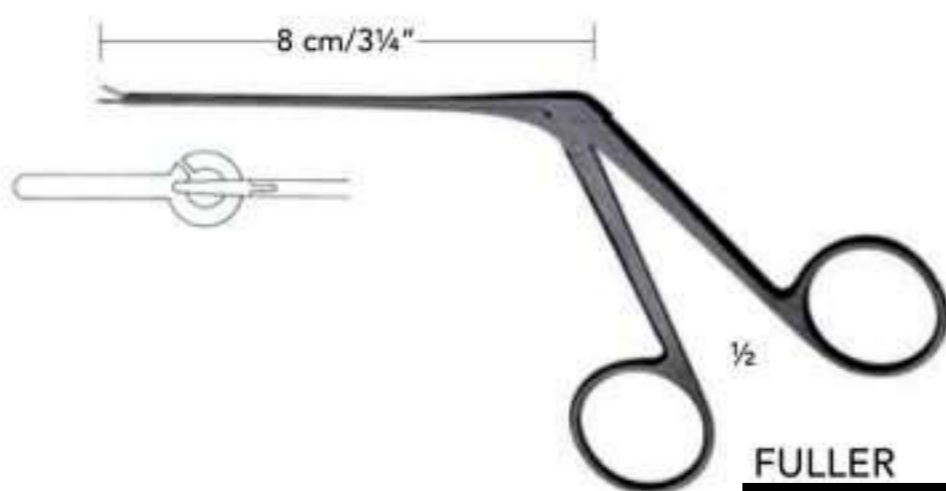

FULLER  
HP-1113-01

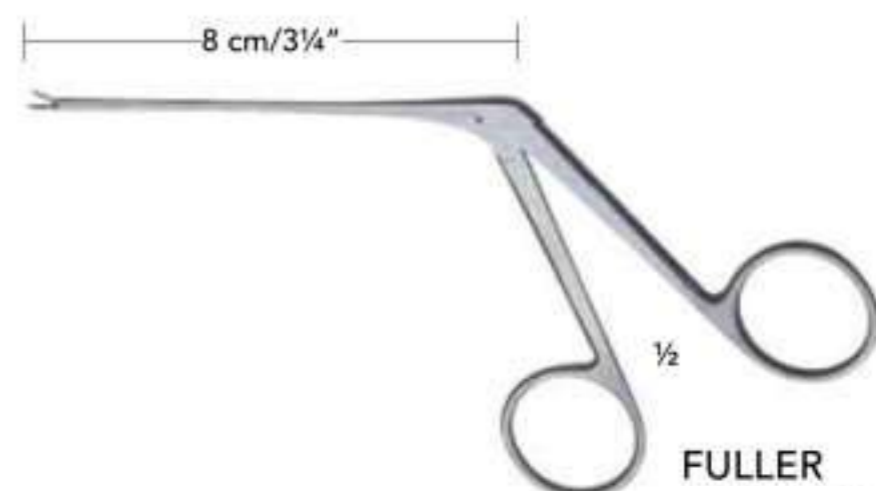

FULLER  
HP-1013-01

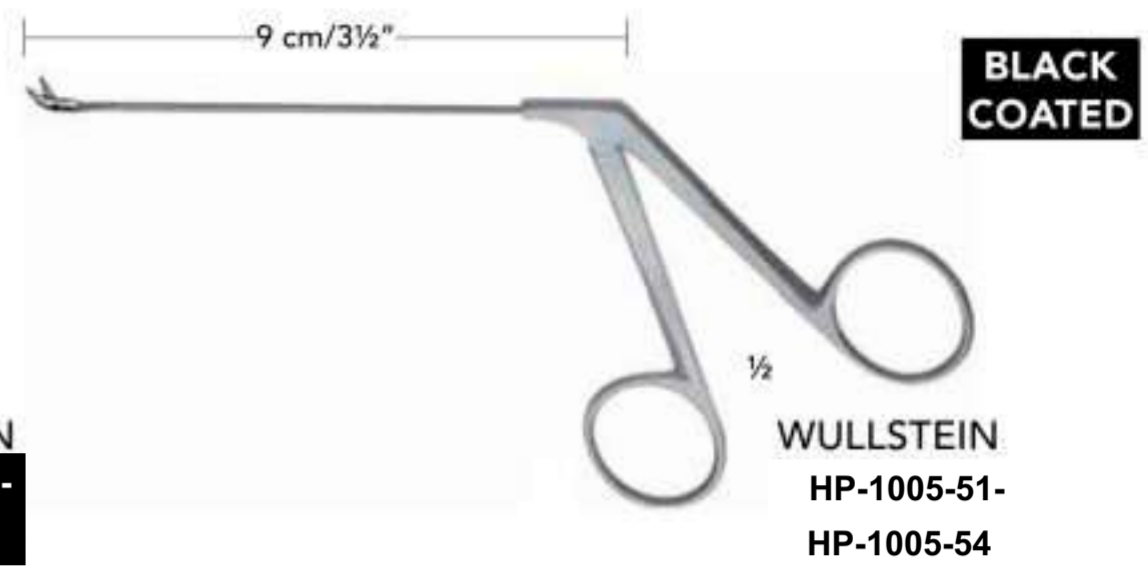
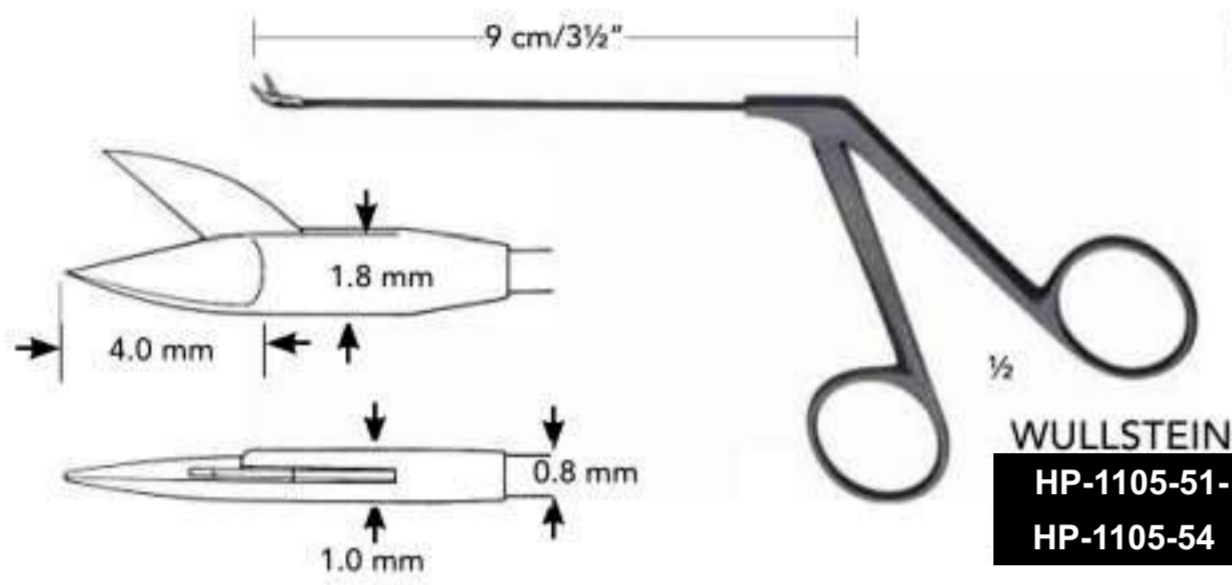

**BLACK COATED**

Straight



HP-1005-51  
HP-1105-51

Bent upwards



HP-1005-52  
HP-1105-52

Right



HP-1005-53  
HP-1105-53

Left

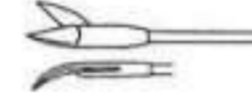

HP-1005-54  
HP-1105-54

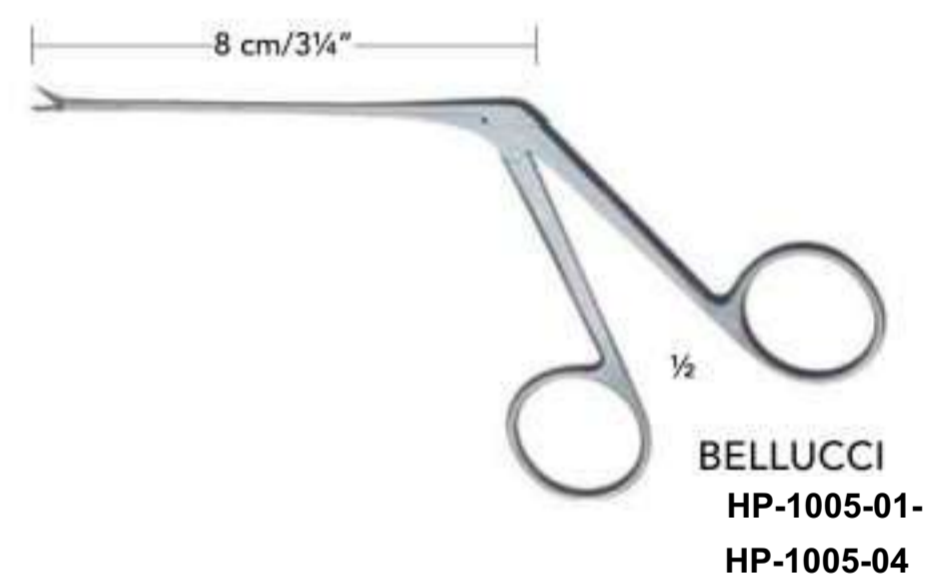
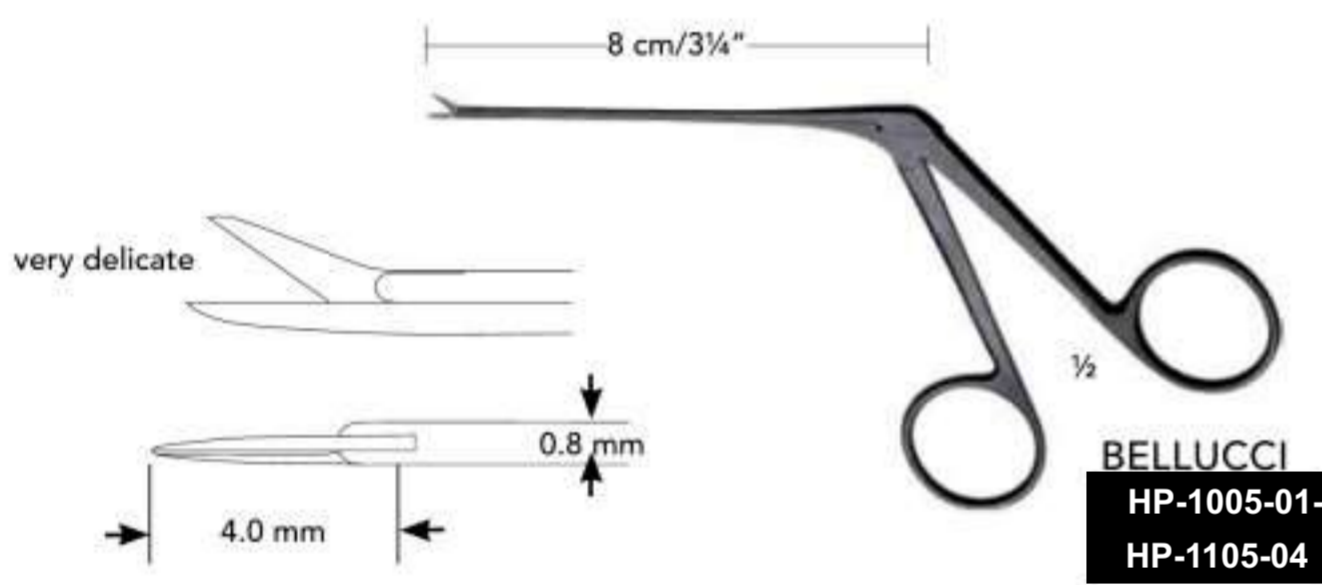

Straight



HP-1005-01  
HP-1105-01

Bent upwards



HP-1005-02  
HP-1105-02

Right



HP-1005-03  
HP-1105-03

Left



HP-1005-04  
HP-1105-04

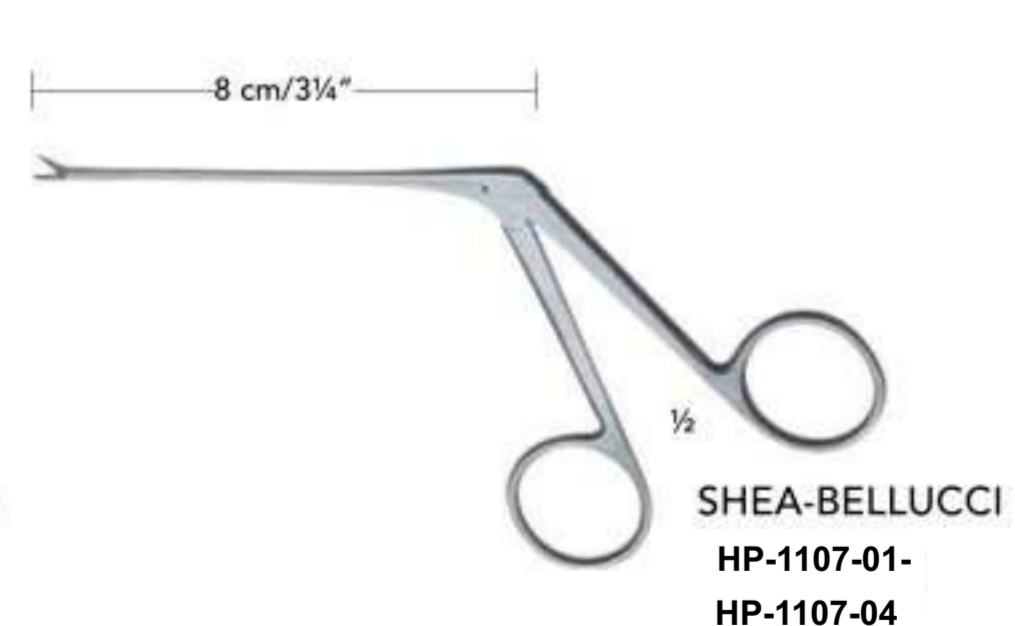
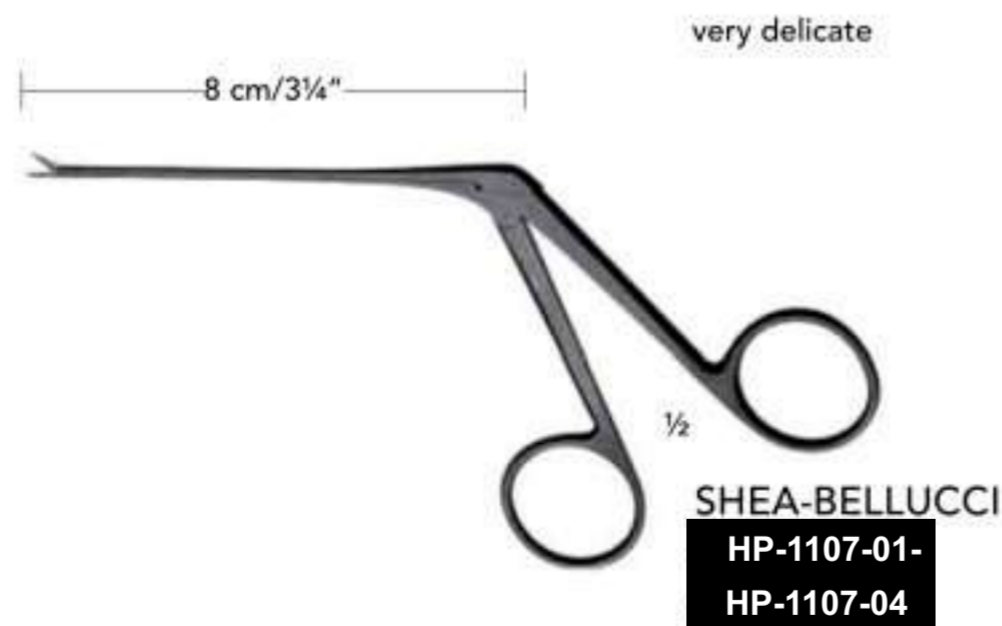

Straight



HP-1007-01  
HP-1107-01

Bent upwards



HP-1007-02  
HP-1107-02

Right



HP-1007-03  
HP-1107-03

Left



HP-1007-04  
HP-1107-04



### Sickle knife



**SCHUKNECHT**  
HP-1020-06  
14.5 cm/5¾"

### Roller knives

#### Vertical



**SCHUKNECHT**  
HP-1020-01  
15.5 cm/6"

#### Horizontal



**SCHUKNECHT**  
HP-1020-02  
15.5 cm/6"

### Micro knife



**ROSEN**  
15 cm/6"

#### Diameter

- Ø 1.0 mm
- Ø 1.4 mm
- Ø 1.5 mm
- Ø 1.6 mm
- Ø 2.0 mm
- Ø 2.3 mm
- Ø 2.5 mm
- Ø 2.6 mm
- Ø 2.8 mm
- Ø 3.0 mm

- HP-1021-20
- HP-1021-09
- HP-1021-10

#### 45°



- HP-1022-10
- HP-1022-14
- HP-1022-16
- HP-1022-20
- HP-1022-26
- HP-1022-28
- HP-1022-30

#### 90°



- HP-1023-10
- HP-1023-15
- HP-1023-16
- HP-1023-20
- HP-1023-23
- HP-1023-25
- HP-1023-26
- HP-1023-28
- HP-1023-30

### Sickle knife



**WULLSTEIN**  
HP-1020-11  
15.5 cm/6"

### Mucosa knife



**TABB**  
HP-1020-16  
15.5 cm/6"

### Flap knife



**PLESTER**  
HP-1020-21  
15 cm/6"

### Ear knives



**SEXTON**  
HP-1513-17  
17 cm/6¾"



**SEXTON-GERZOG**  
HP-1514-17  
17 cm/6¾"

Tympanum needles



POLITZER  
HP-1630-16  
17.5 cm/7"



POLITZER  
HP-1616-13  
16 cm/6¼"



POLITZER  
HP-1655-16  
15.5 cm/6"



POLITZER  
HP-1657-16  
16 cm/6¼"



LUCAE  
HP-1661-18  
18 cm/7"



LUCAE  
HP-1663-18  
17.5 cm/7"

Micro ear needles



16 cm/6¼"



BARBARA  
HP-1624-01



BARBARA  
HP-1624-02



BARBARA  
HP-1624-03



ROSEN  
HP-1624-04



25°

- 0.3 mm HP-1024-06
- 0.6 mm HP-1024-07
- 1.0 mm HP-1024-08

Micro ear hooks



45°



90°

- |        |            |            |
|--------|------------|------------|
| 0.3 mm | VI-1024-11 | VI-1024-21 |
| 0.6 mm | VI-1024-12 | VI-1024-22 |
| 1.0 mm | VI-1024-13 | VI-1024-23 |
| 1.2 mm | VI-1024-14 | VI-1024-24 |
| 1.5 mm | VI-1024-15 | VI-1024-25 |
| 2.0 mm | VI-1024-16 | VI-1024-26 |
| 2.5 mm | VI-1024-17 | VI-1024-27 |

Micro ear needles



HP-1029-01



HP-1029-02



- 0.5 mm VI-1024-31
- 1.0 mm VI-1024-32

BARBARA  
15.5 cm/6"



Micro hooks, Picks

	Straight	25° Angled
0.3 mm	VI-1026-03	VI-1027-03
0.5 mm	VI-1026-05	VI-1027-05
0.6 mm	VI-1026-06	VI-1027-06
1.0 mm	VI-1026-10	VI-1027-10



SHAMBAUGH  
16 cm/6¼"

Micro otology hooks

	25° Upwards	25° Downwards
0.3 mm	VI-1040-11	VI-1041-16
0.6 mm	VI-1040-12	VI-1041-17
1.0 mm	VI-1040-13	VI-1041-18



15.5 cm/6¼"

	45° Angled	90° Angled
0.3 mm	VI-1032-03	40-1034-03
0.5 mm	VI-1032-05	40-1034-05
0.6 mm	VI-1032-06	40-1034-06
1.0 mm	VI-1032-10	40-1034-10
1.2 mm	VI-1032-12	40-1034-12
1.5 mm	VI-1032-15	40-1034-15
2.0 mm	VI-1032-20	40-1034-20
2.5 mm	VI-1032-25	40-1034-25

	45° Upwards	45° Downwards
0.3 mm	VI-1042-21	VI-1043-26
0.6 mm	VI-1042-22	VI-1043-27
1.0 mm	VI-1042-23	VI-1043-28

	90° Upwards	90° Downwards
0.3 mm	VI-1045-03	VI-1046-03
0.6 mm	VI-1045-06	VI-1046-06
1.0 mm	VI-1045-10	VI-1046-10

Micro dissectors

	angled to right	angled to left
HP-1036-01	15 cm/6"	HP-1036-02
HP-1036-05	15.5 cm/6¼"	HP-1036-06

FISCH

HOUSE  
15.5 cm/6¼"

Micro measuring rods

HP-1038-01	Ø 3.5 mm
HP-1038-02	Ø 4.0 mm
HP-1038-03	Ø 4.5 mm
HP-1038-04	Ø 5.0 mm

Foreign body levers

MOLDENHAUER	HP-1561-16
ZAUFAL	HP-1563-16

16 cm/6¼"

15 cm/6"

Periosteal elevators



**LEMPERT**  
**HP-1737-20**  
20.5 cm/8"



**LEMPERT**  
**HP-1739-17**  
18 cm/7"

Ear scoop sharp



**HP-1743-10**  
Fig. 1



**HP-1743-20**  
Fig. 2



**HP-1743-30**  
Fig. 3



**HP-1743-40**  
Fig. 4



**HP-1743-50**  
Fig. 5



**LEMPERT**  
21.5 cm/8 1/2"

Foreign body instrument

Micro ear periosteal elevator



**ROSEN**  
**HP-1036-23**  
15 cm/6"



**WEBER-LOCH**  
**HP-1551-01**  
17 cm/6"



**SHAPLEIGH**  
15 cm/6"

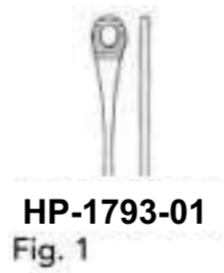

**HP-1793-01**  
Fig. 1



**HP-1493-02**  
Fig. 2

Micro curettes



**HP-1044-01**



Ø 1.2 mm



**HP-1044-02**



Ø 1.8 mm



**HP-1044-03**



Ø 1.2 mm



**HOUSE**  
14.5 cm/5 3/4"



sharp	HP-1494-01	HP-1494-02	HP-1494-10	HP-1494-11	HP-1494-12	HP-1494-13	HP-1494-14
	1.8 mm Fig. 000	2.1 mm Fig. 00	2.6 mm Fig. 0	3.2 mm Fig. 1	3.7 mm Fig. 2	4.1 mm Fig. 3	4.4 mm Fig. 4
blunt	HP-1495-01	HP-1495-02	HP-1495-10	HP-1495-11	HP-1495-12	HP-1495-13	HP-1495-14
	1.8 mm Fig. 000	2.1 mm Fig. 00	2.6 mm Fig. 0	3.2 mm Fig. 1	3.7 mm Fig. 2	4.1 mm Fig. 3	4.4 mm Fig. 4
sharp	HP-1496-01	HP-1496-02	HP-1496-10	HP-1496-11	HP-1496-12	HP-1496-13	HP-1496-14
	1.8 mm Fig. 000	2.1 mm Fig. 00	2.6 mm Fig. 0	3.2 mm Fig. 1	3.7 mm Fig. 2	4.1 mm Fig. 3	4.4 mm Fig. 4
blunt	HP-1497-01	HP-1497-02	HP-1497-10	HP-1497-11	HP-1497-12	HP-1497-13	HP-1497-14
	1.8 mm Fig. 000	2.1 mm Fig. 00	2.6 mm Fig. 0	3.2 mm Fig. 1	3.7 mm Fig. 2	4.1 mm Fig. 3	4.4 mm Fig. 4

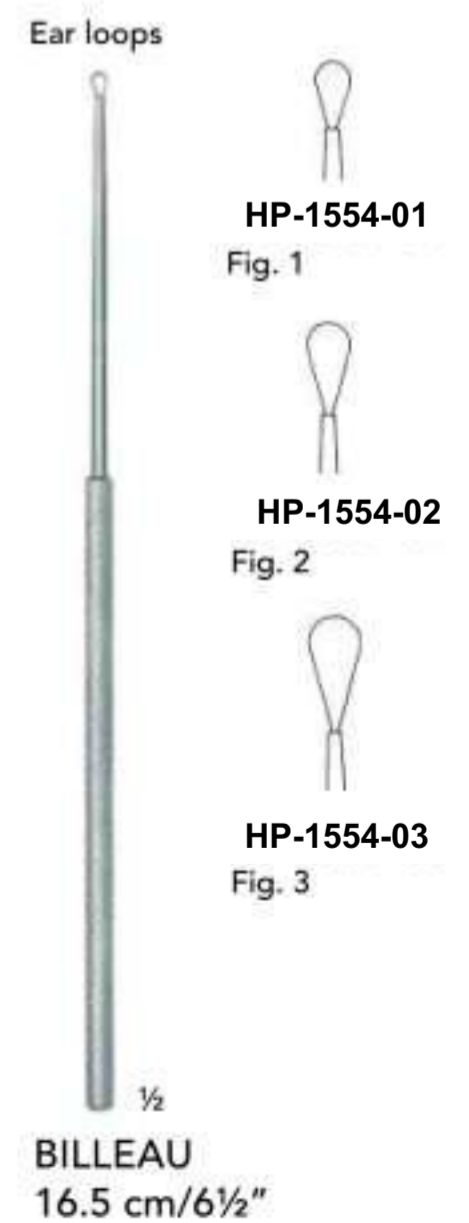

○  
**HP-1112-10**  
 Ø 3 mm  
 Fig. 0

○  
**HP-1112-11**  
 Ø 4 mm  
 Fig. 1

○  
**HP-1112-12**  
 Ø 5 mm  
 Fig. 2

○  
**HP-1112-13**  
 Ø 6 mm  
 Fig. 3

○  
**HP-1112-14**  
 Ø 7.5 mm  
 Fig. 4

○  
**HP-1113-30**  
 Ø 3 mm  
 Fig. 1

○  
**HP-1113-45**  
 Ø 4.5 mm  
 Fig. 3

○  
**HP-1113-55**  
 Ø 5.5 mm  
 Fig. 5

○  
**HP-1113-65**  
 Ø 6.5 mm  
 Fig. 7

○  
**HP-1113-75**  
 Ø 7.5 mm  
 Fig. 9

○  
**HP-1113-40**  
 Ø 4 mm  
 Fig. 2

○  
**HP-1113-50**  
 Ø 5.0 mm  
 Fig. 4

○  
**HP-1113-60**  
 Ø 6.0 mm  
 Fig. 6

○  
**HP-1113-70**  
 Ø 7.0 mm  
 Fig. 8



**HARTMANN**  
 3.6 cm/1½"

Fig.

Set of 3	0-3	HP-1112-03
Set of 3	2-4	HP-1114-03
Set of 4	1-4	HP-1115-04



**HARTMANN**

Fig.

Set of 3	1, 2, 4	KI-1113-03
Set of 4	3, 5, 7, 9	KI-1113-04
Set of 4	2, 4, 6, 8	KI-1114-04

○  
**HP-1115-05**  
 4.5 x 5 mm

○  
**HP-1115-06**  
 5.5 x 6 mm

○  
**HP-1115-07**  
 6.5 x 7 mm

○  
**HP-1115-08**  
 7.5 x 8 mm

Chrome plated, Oval



**HARTMANN**



**TOYNBEE**  
 3.6 cm/1½"

Fig

Set for 3	2 - 4	HP-1118-03
Set for 4	1 - 4	HP-1119-04

○  
**HP-1118-11**  
 Ø 4 mm  
 Fig. 1

○  
**HP-1118-12**  
 Ø 5 mm  
 Fig. 2

○  
**HP-1118-13**  
 Ø 6 mm  
 Fig. 3

○  
**HP-1118-14**  
 Ø 7.5 mm  
 Fig. 4

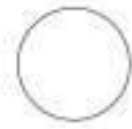

**VI-1120-82**  
Ø 8.2 mm

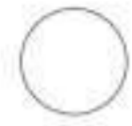

**VI-1120-77**  
Ø 7.7 mm

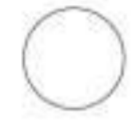

**VI-1120-72**  
Ø 7.2 mm

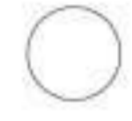

**VI-1120-67**  
Ø 6.7 mm

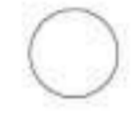

**VI-1120-63**  
Ø 6.3 mm

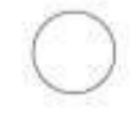

**VI-1120-58**  
Ø 5.8 mm



**VI-1120-53**  
Ø 5.3 mm



**VI-1120-48**  
Ø 4.8 mm



**VI-1120-43**  
Ø 4.3 mm



**HP-1120-38**  
Ø 3.8 mm



**HP-1120-33**  
Ø 3.3 mm

Satin finish, round



FARRIOR

Satin finish, oval



FARRIOR



**VI-1121-80**  
9.0 mm

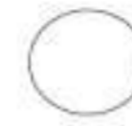

**VI-1121-75**  
8.5 mm

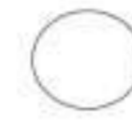

**VI-1121-70**  
8.0 mm



**VI-1121-65**  
7.5 mm

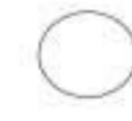

**VI-1121-60**  
7.0 mm

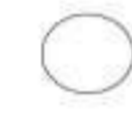

**VI-1121-55**  
6.5 mm



**VI-1121-50**  
6.0 mm



**VI-1121-45**  
5.5 mm



**VI-1121-40**  
5.0 mm



**HP-1121-35**  
4.5 mm



**HP-1121-33**  
4.0 mm

Satin finish, oval



FARRIOR



**VI-1122-80**  
9.0 mm



**VI-1122-75**  
8.5 mm

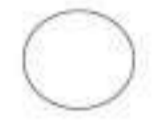

**VI-1122-70**  
8.0 mm



**VI-1122-65**  
7.5 mm



**VI-1122-60**  
7.0 mm

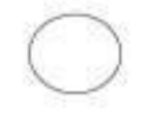

**VI-1122-55**  
6.5 mm



**VI-1122-50**  
6.0 mm



**VI-1122-45**  
5.5 mm



**VI-1122-40**  
5.0 mm



**HP-1122-35**  
4.5 mm



**HP-1122-33**  
4.0 mm



**HP-1148-12**  
Ear specula storage rack

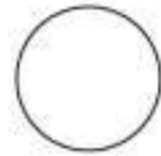
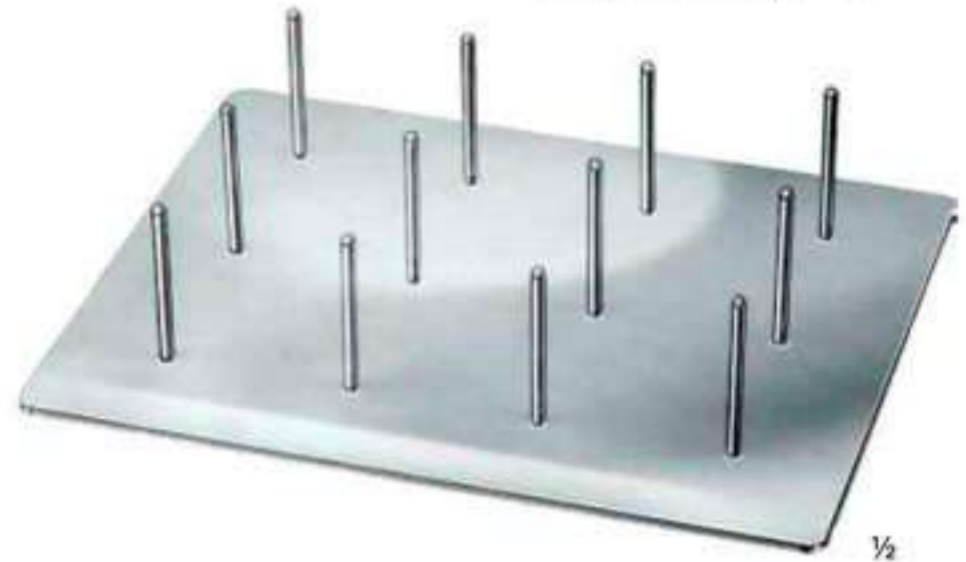

**HP-1134-07**  
Ø 11.5 mm  
Fig. 7

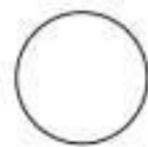

**HP-1134-06**  
Ø 11.5 mm  
Fig. 6



**HP-1134-05**  
Ø 10.5 mm  
Fig. 5

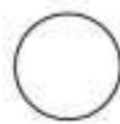

**HP-1134-04**  
Ø 8.5 mm  
Fig. 4



**HP-1134-03**  
Ø 7.5 mm  
Fig. 3



**HP-1134-02**  
Ø 6.5 mm  
Fig. 2



**HP-1134-01**  
Ø 5.5 mm  
Fig. 1



**HP-1132-00**  
Fig. 1-6  
Complete set

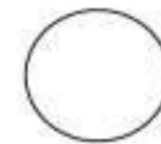

**HP-1132-06**  
11.5 mm  
Fig. 6

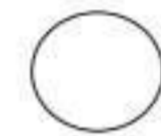

**HP-1132-05**  
10.5 mm  
Fig. 5

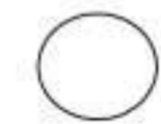

**HP-1132-04**  
9.5 mm  
Fig. 4



**HP-1132-03**  
8.5 mm  
Fig. 3



**HP-1132-02**  
7.5 mm  
Fig. 2



**HP-1132-01**  
6.5 mm  
Fig. 1



FRENCH  
HP-1170-07  
C<sup>2</sup> 16



FRENCH  
HP-1172-08  
C<sup>1</sup> 32



HARTMANN  
HP-1172-09  
C 64



HARTMANN  
HP-1174-10  
C 128



HARTMANN  
HP-1177-11  
C<sup>1</sup> 256



with dampers

**ALUMINIUM**



**HP-1190-00**

Set of 5  
(C 128 Hz - C 2048 Hz)

**HP-1180-10**  
C 128

**HP-1182-11**  
C 256

**HP-1184-12**  
C 512

**HP-1186-13**  
C 1024

**HP-1188-14**  
C 2048



**HARTMANN**  
**HP-1189-10**  
C 128

**HARTMANN**  
**HP-1192-11**  
C¹ 256

**HARTMANN**  
**HP-1194-12**  
C² 512

**HARTMANN**  
**HP-1196-13**  
C³ 1024

**HARTMANN**  
**HP-1198-14**  
C⁴ 2048

**HARTMANN**  
**HP-1200-15**  
C⁵ 4096



LUCAE  
HP-1210-10  
C 128



LUCAE  
HP-1212-11  
C<sup>1</sup> 256



LUCAE  
HP-1214-12  
C<sup>2</sup> 512

HP-1216-98  
Socket only



LUCAE  
HP-1216-13  
C<sup>3</sup> 1024



LUCAE  
HP-1218-14  
C<sup>4</sup> 2048



LUCAE  
HP-1220-15  
C<sup>5</sup> 4096



LUCAE  
HP-1221-10  
C 128

HP-1221-98  
Socket only

with hammer, pinwheel,  
brush & wheel for Neuro



**RYDEL-SEIFFERT**  
HP-1224-10  
C 64/C 128

HP-1224-90  
Damper white  
scale for

HP-1224-91  
Damper black  
scale for

HP-1224-92

HP-1224-93



HP-1226-00  
C 64/C 128

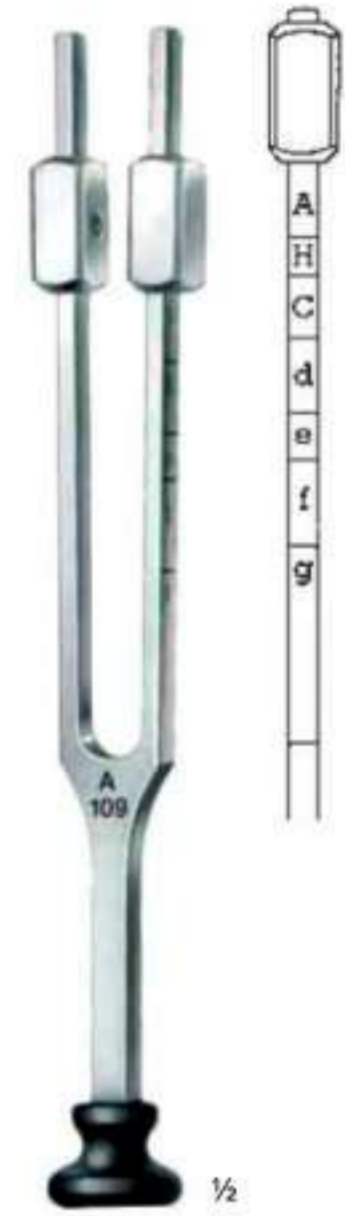

**KOENIG**  
HP-1230-59  
A 109



**HARTMANN**  
HP-1223-11  
C' 128

HP-1223-98  
Socket only

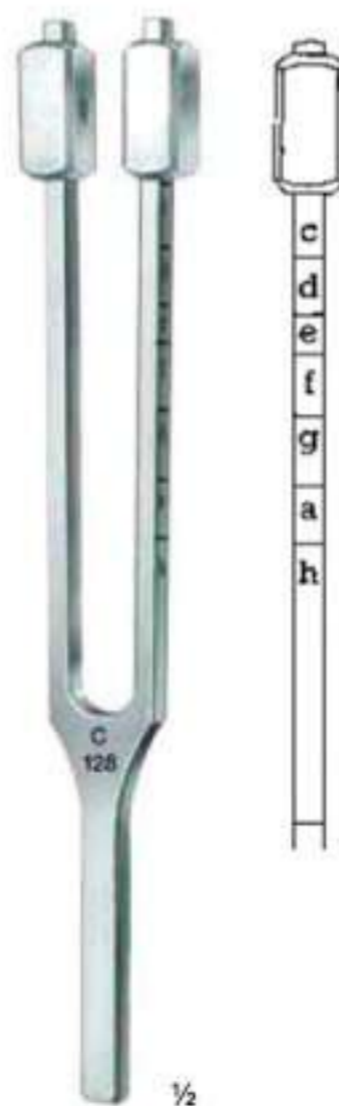

**HARTMANN**  
HP-1222-10  
C 128

HP-1234-90  
Bakelit base



**HP-1234-61**  
a<sup>1</sup> 440

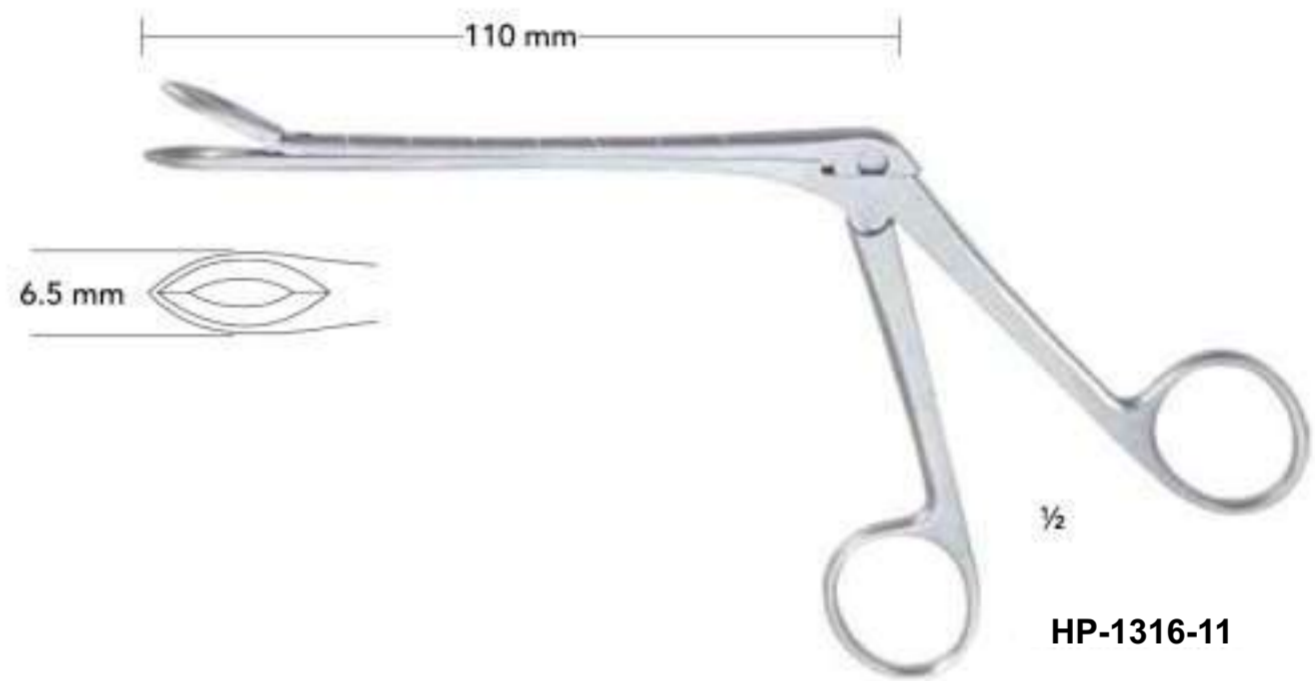
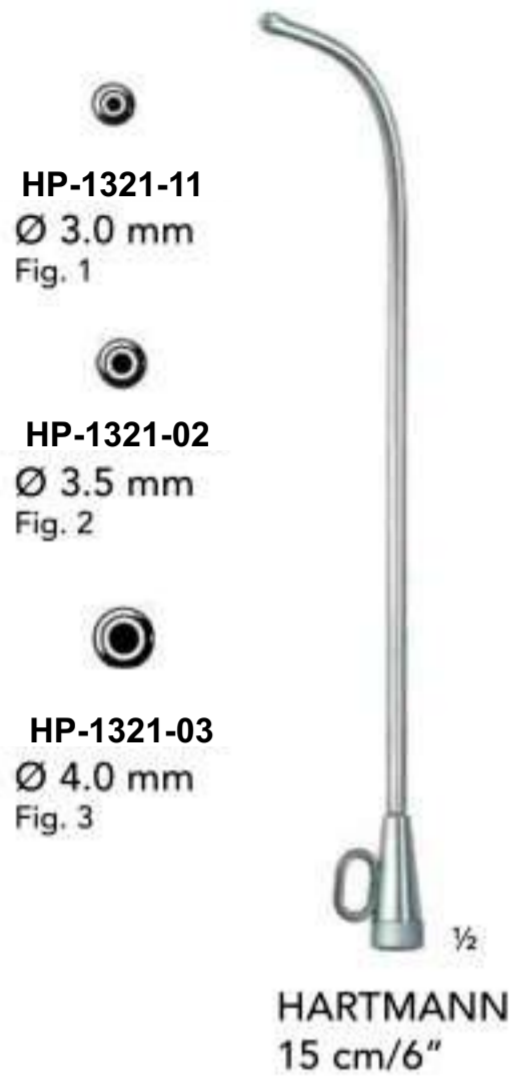

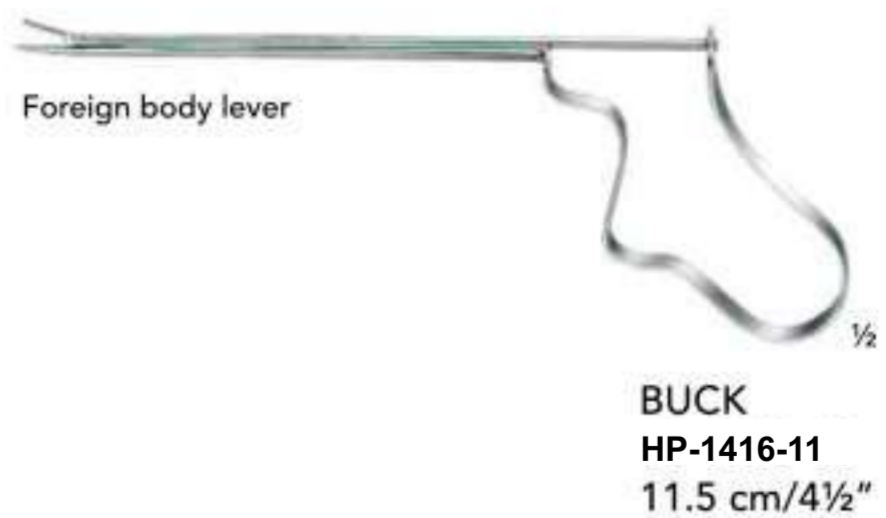
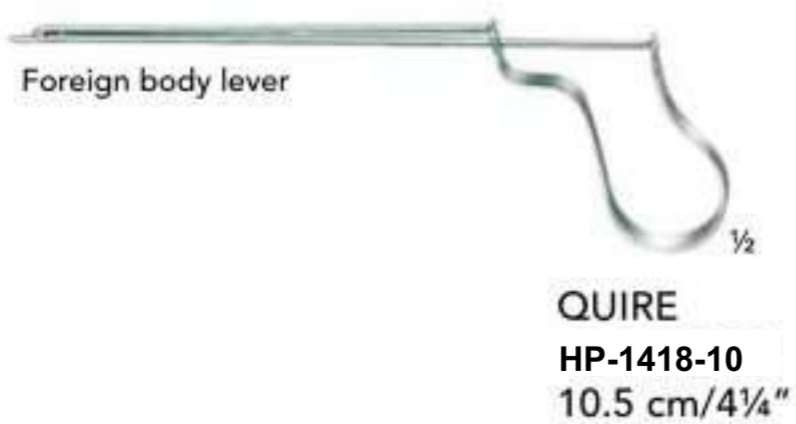
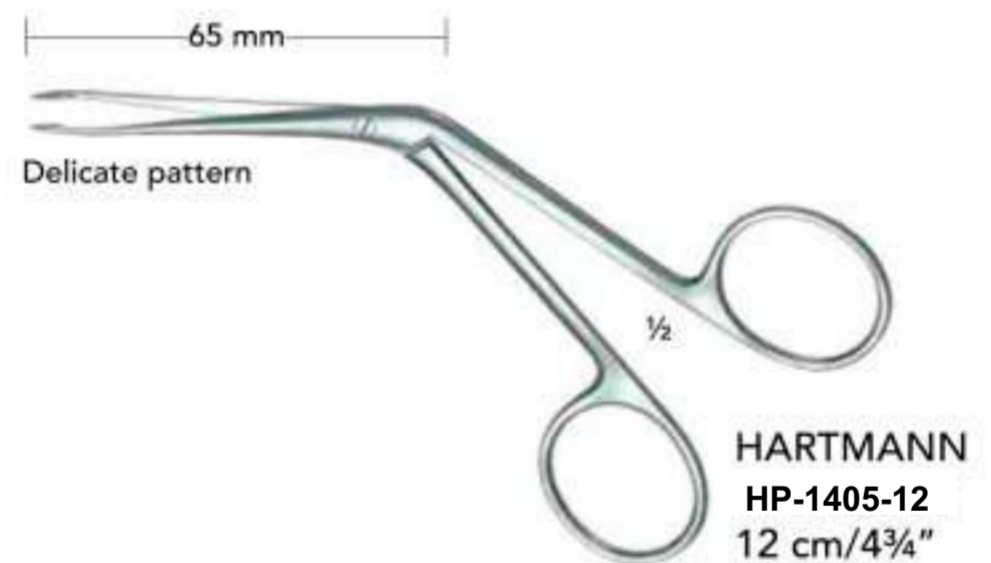
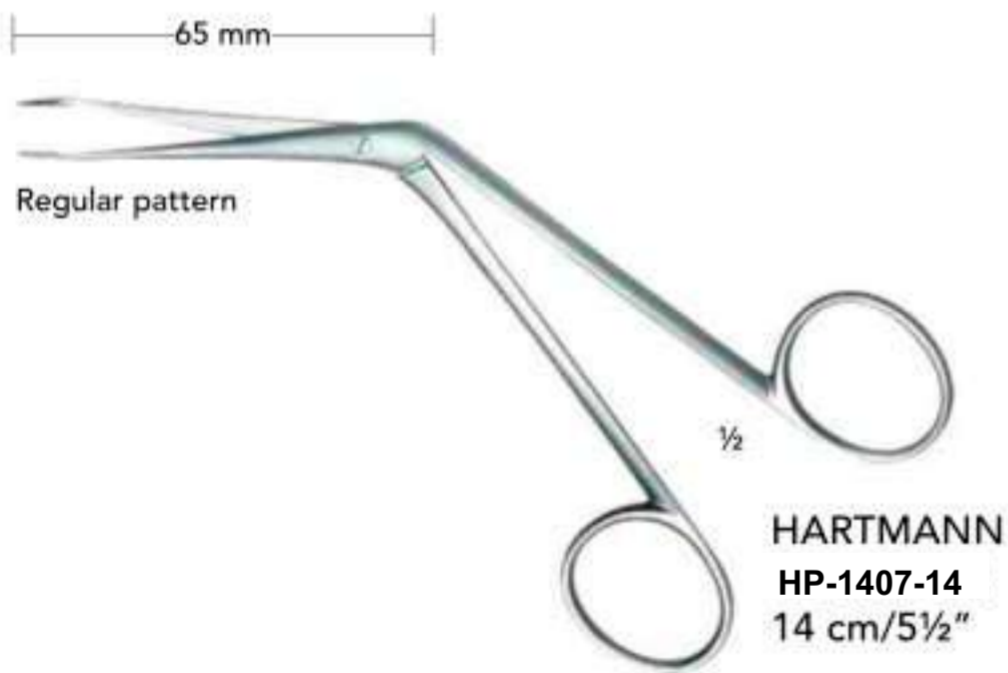
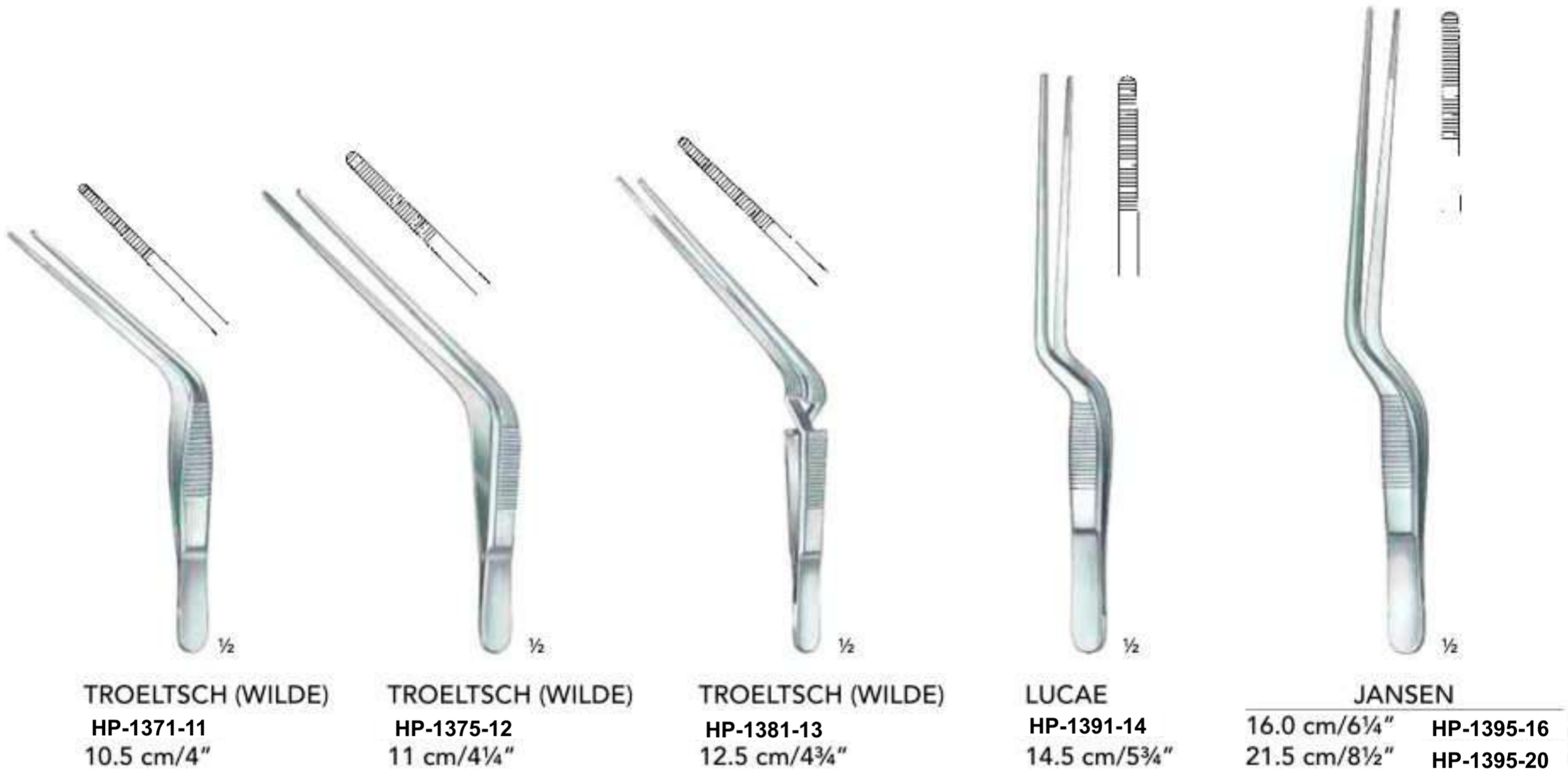



Serrated



**HARTMANN-WULLSTEIN**  
 1.8 x 4.0 mm **HP-1425-04**  
 1.8 x 8.0 mm **HP-1425-08**

Smooth



**HARTMANN-WULLSTEIN**  
 1.8 x 8.0 mm **HP-1426-04**



**HARTMANN-WULLSTEIN**  
 8.5 cm/3 1/4"  
 Ø 1.0 mm **VI-1442-10**  
 Ø 2.0 mm **VI-1442-20**  
 Ø 2.5 mm **VI-1442-25**  
 Ø 3.0 mm **VI-1442-30**

Serrated



**HARTMANN**  
 8.5 cm/3 1/4" **VI-1430-08**  
 14 cm/5 1/2" **VI-1430-14**  
 16.5 cm/6 1/2" **VI-1430-16**

1:2



**HARTMANN**  
 8.5 cm/3 1/2" **VI-1431-08**  
 14 cm/5 1/2" **VI-1431-14**

Ø 3 mm



**HARTMANN**  
**HP-1445-08**  
 8.5 cm/3 1/4"

Ø 2 mm



**HARTMANN-HERZFELD**  
**HP-1442-81**  
 8.5 cm/3 1/4"

Ø 2.5 mm



**HARTMANN-HERZFELD**  
**HP-1442-82**  
 8.5 cm/3 1/4"

Ø 3 mm



**HARTMANN-HERZFELD**  
**HP-1442-83**  
 8.5 cm/3 1/4"

through cutting  
 Ø 2 mm



**HARTMANN-HOFFMANN**  
**HP-1456-08**  
 8.5 cm/3 1/4"



**HARTMANN-NOYES**  
 Serrated **HP-1434-09**  
 1x2 teeth **HP-1435-09**



**STRÜMPEL**  
**HP-1448-08**  
 8.5 cm/3 1/4"



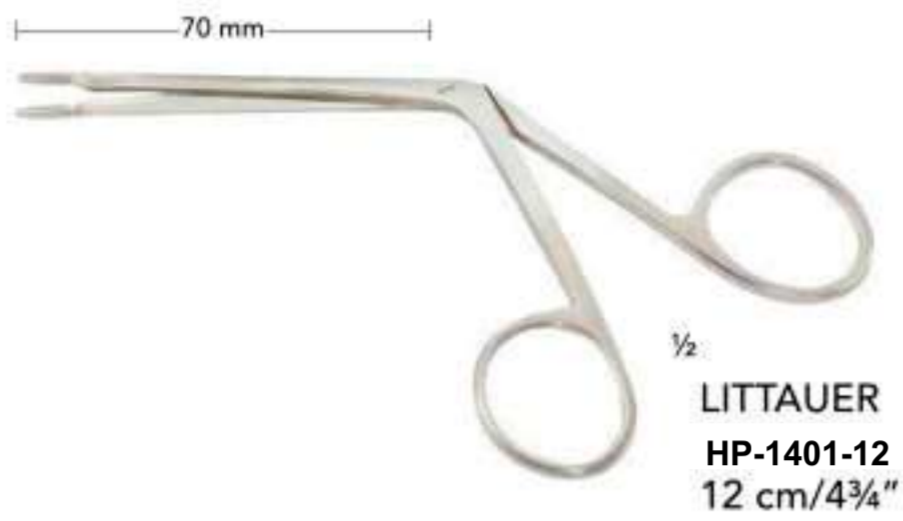

### Mastoid Rongeurs

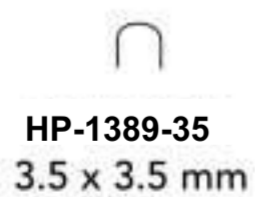
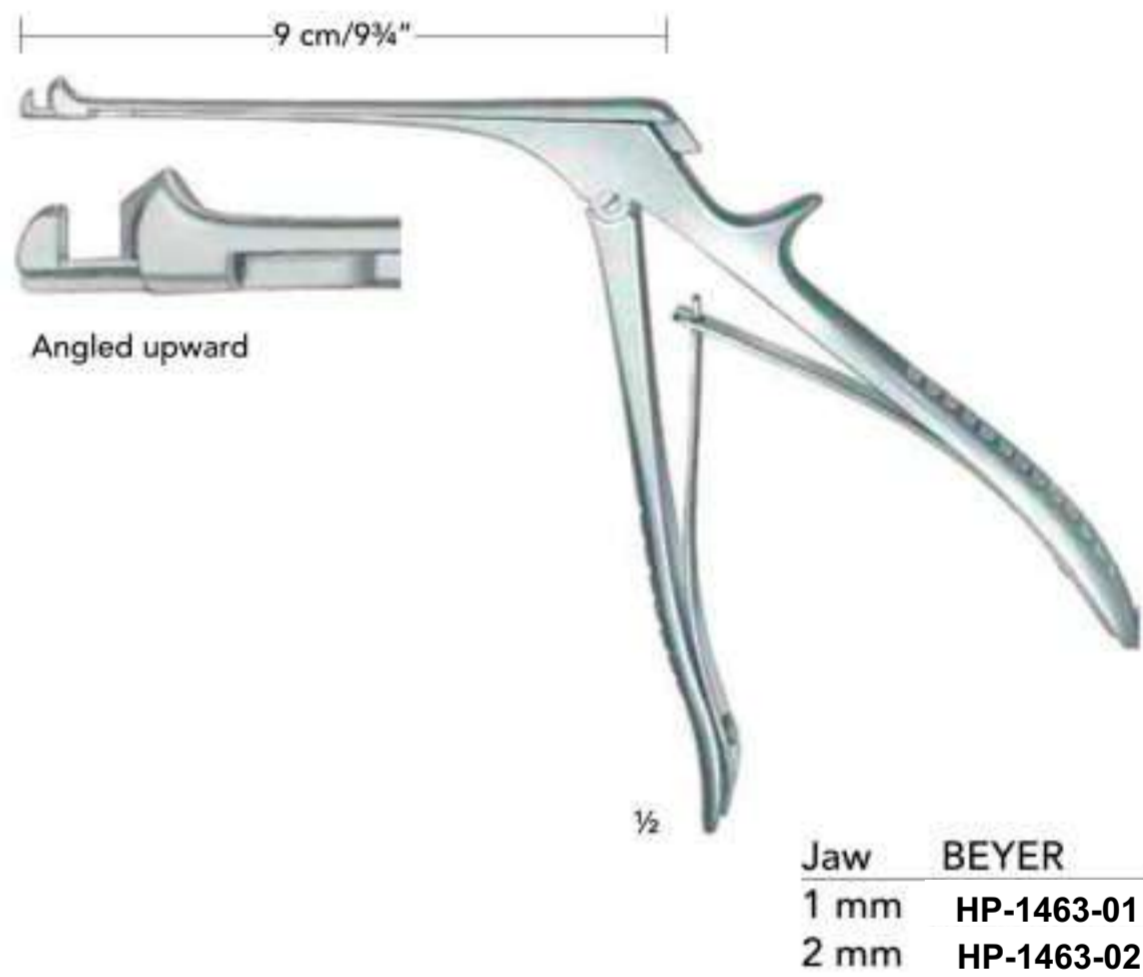

Valve Attachment



HP-1794-02

Suction Nozzle



HP-1794-04

Protecting Disc



HP-1794-05

Metal Olive



HP-1794-06

Conical tip



HP-1794-07

Button ended tip



HP-1794-08

Threaded tip



HP-1794-09



HP-1794-03

Flexible tube



HP-1794-00

Complete, self filling  
in plastic pouch

HP-1794-90

Rubber gasket

HP-1794-91

Retention spring

HP-1795-01

Syringe, only  
10 ml

**HP-1795-90**

Complete ear syringe with shield & 2 tips

Irrigation adapters



All metal syringe only Luer-Lock



**SCHIMMELBUSCH**

50 ml	<b>VI-1795-50</b>
75 ml	<b>VI-1795-75</b>
100 ml	<b>VI-1795-10</b>
150 ml	<b>VI-1795-15</b>
200 ml	<b>VI-1795-20</b>

**SCHIMMELBUSCH**

50 ml	<b>VI-1796-50</b>
75 ml	<b>VI-1796-75</b>
100 ml	<b>VI-1796-10</b>
150 ml	<b>VI-1796-15</b>
200 ml	<b>VI-1796-20</b>

Accessories for SCHIMMELBUSCH

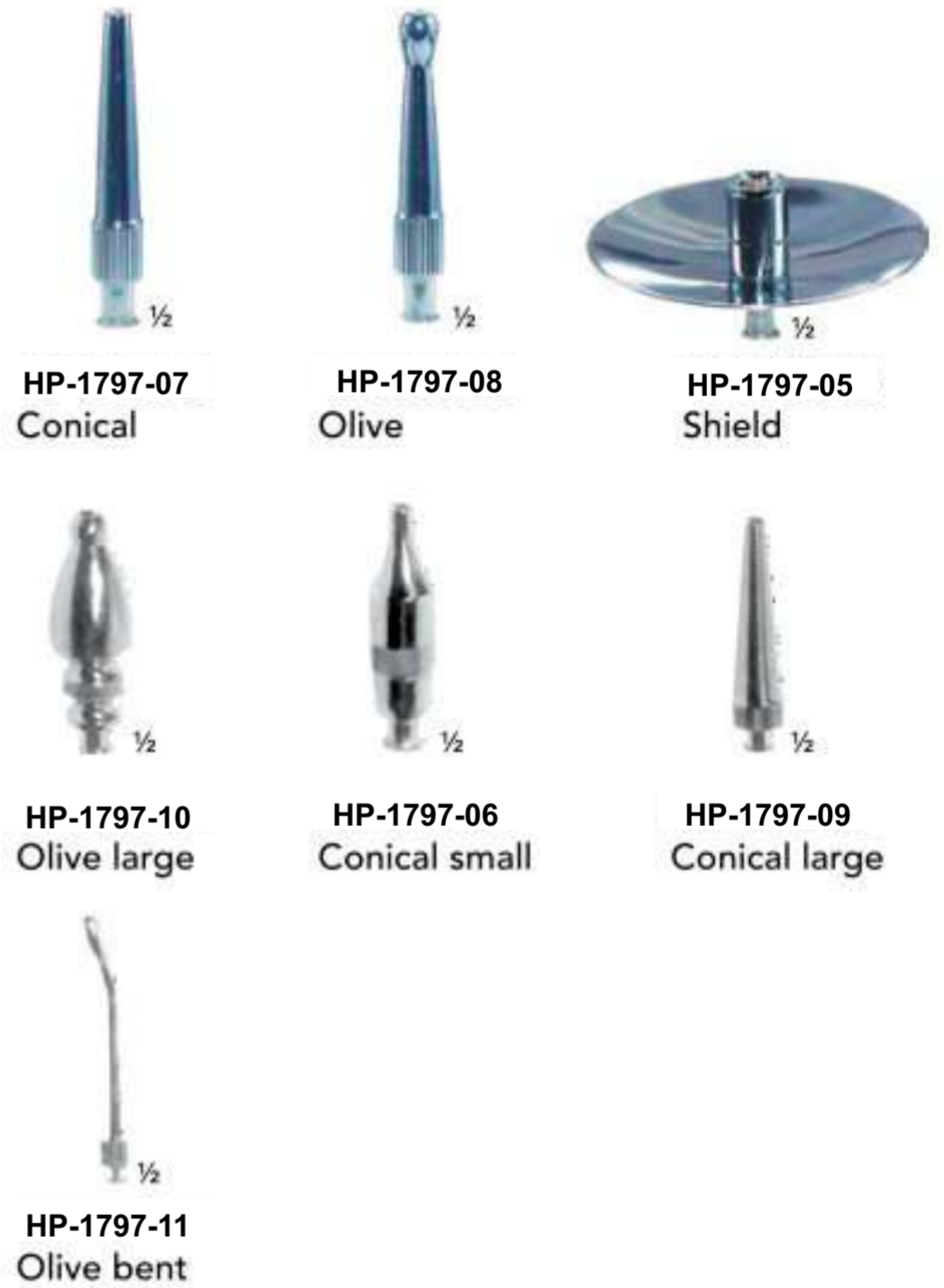

## Rhinology

- Adenoid Currettes
- Cartilage Crushers
- Chisels
- Elevators
- Osteotomes
- Gouges
- Nasal Cutting Forceps
- Nasal Dressing Forceps
- Nasal Knives
- Nasal Rasps
- Nasal Retractors
- Nasal Speculas
- Polypus Forceps
- Retractors
- Septum Forceps
- Skin Hooks



**HARTMANN**  
16.5 cm/6½"

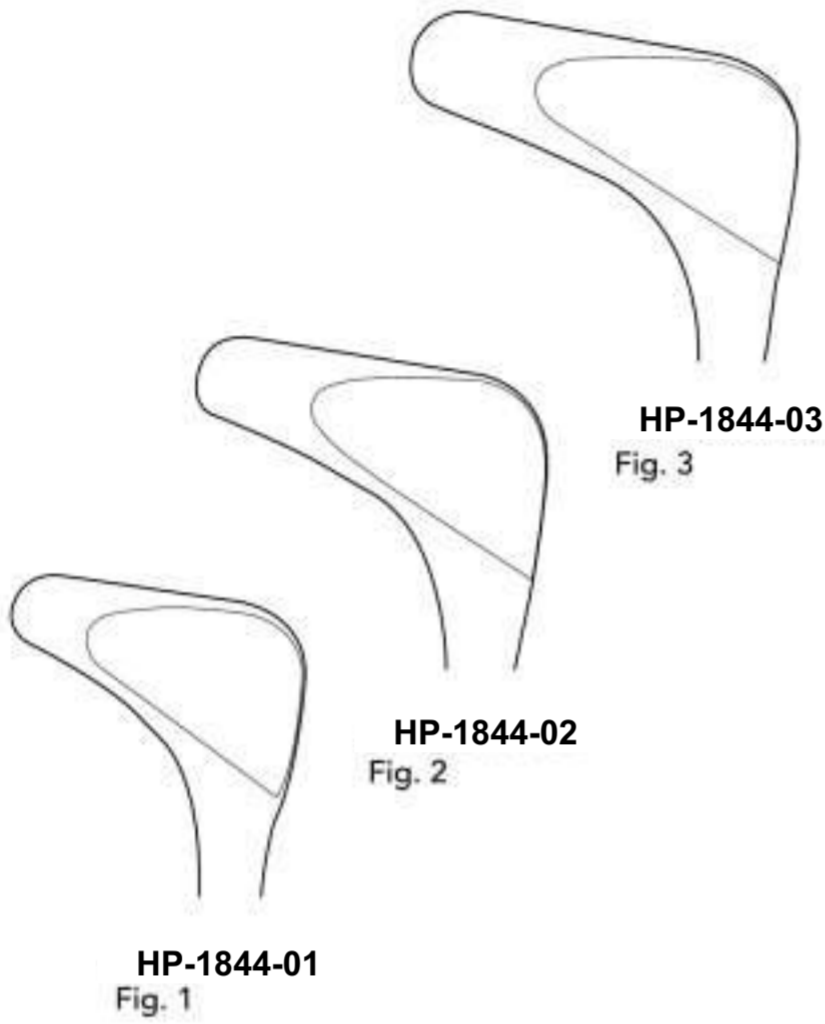

**HP-1844-01**  
Fig. 1

**HP-1844-02**  
Fig. 2

**HP-1844-03**  
Fig. 3



**HARTMANN-HALLE**  
14 cm/5½"

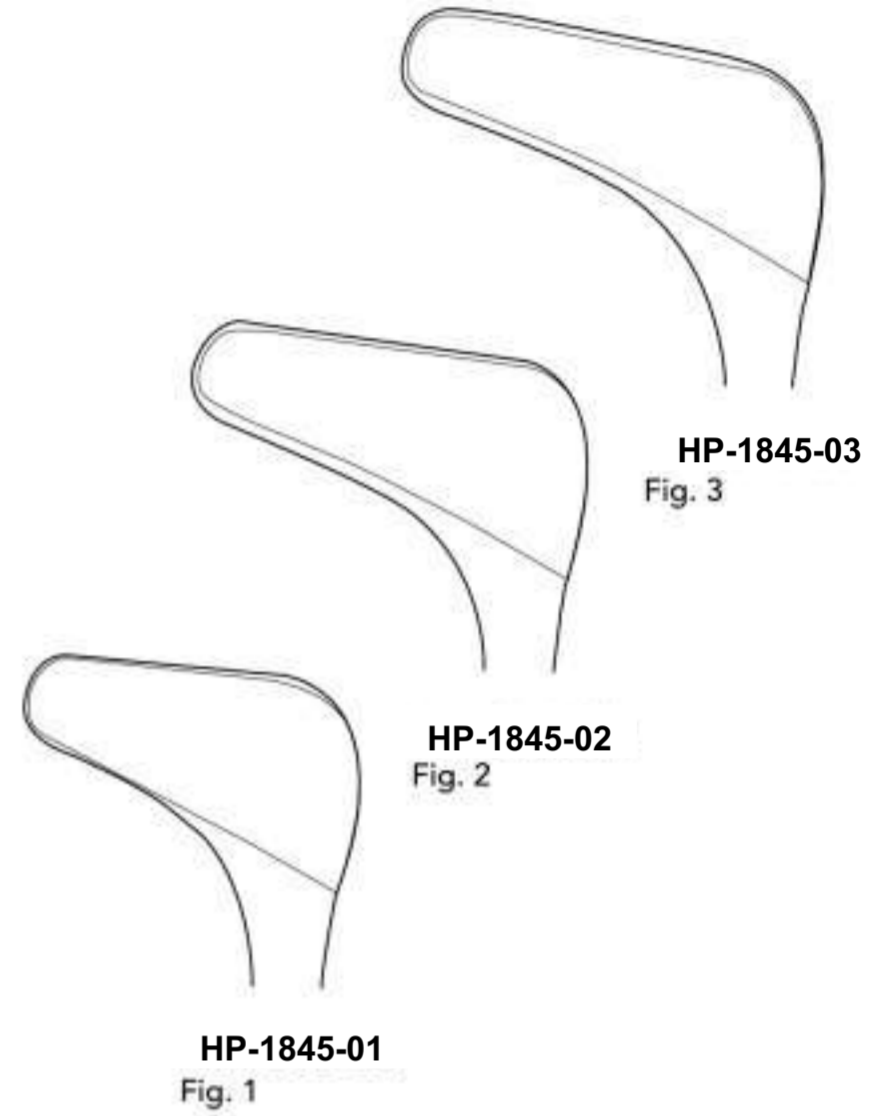

**HP-1845-01**  
Fig. 1

**HP-1845-02**  
Fig. 2

**HP-1845-03**  
Fig. 3



**VIENNA**  
14 cm/5½"

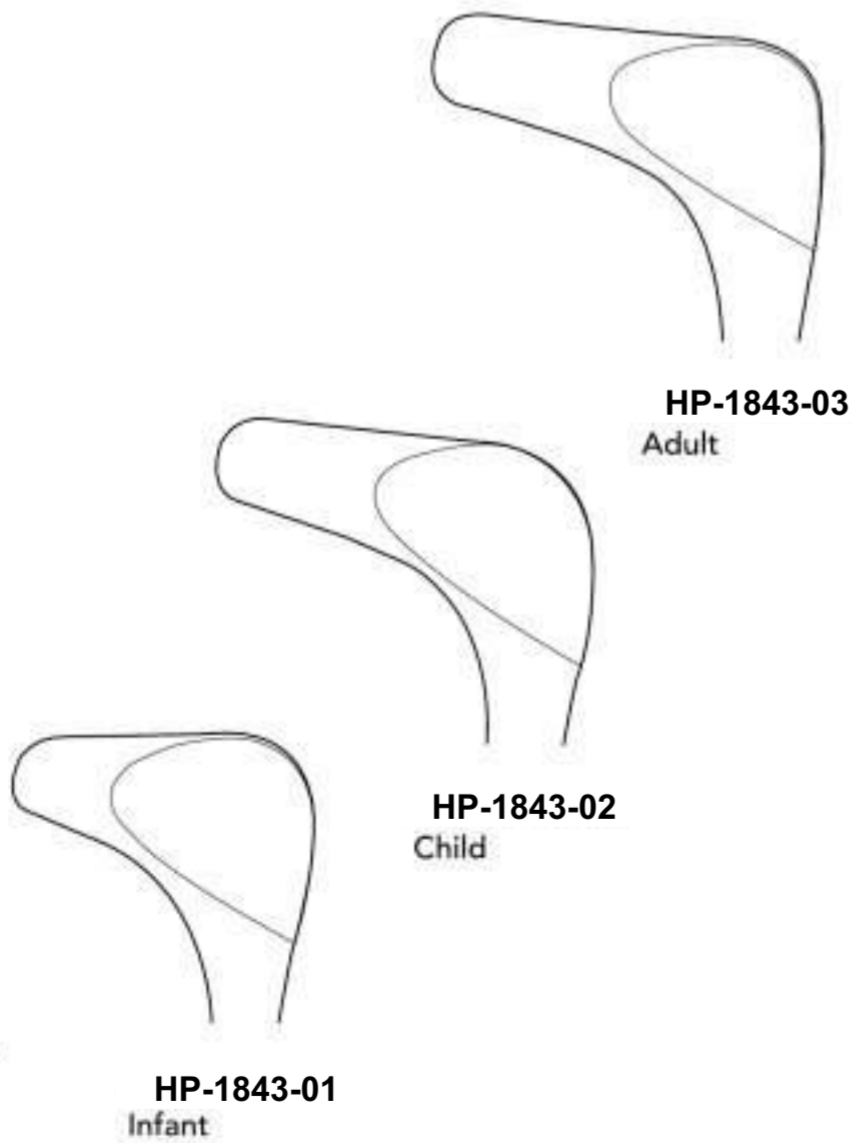

**HP-1843-01**  
Infant

**HP-1843-02**  
Child

**HP-1843-03**  
Adult



**VIENNA**  
**HP-1844-00**  
14 cm/5½"

light weight from  
sheet metal

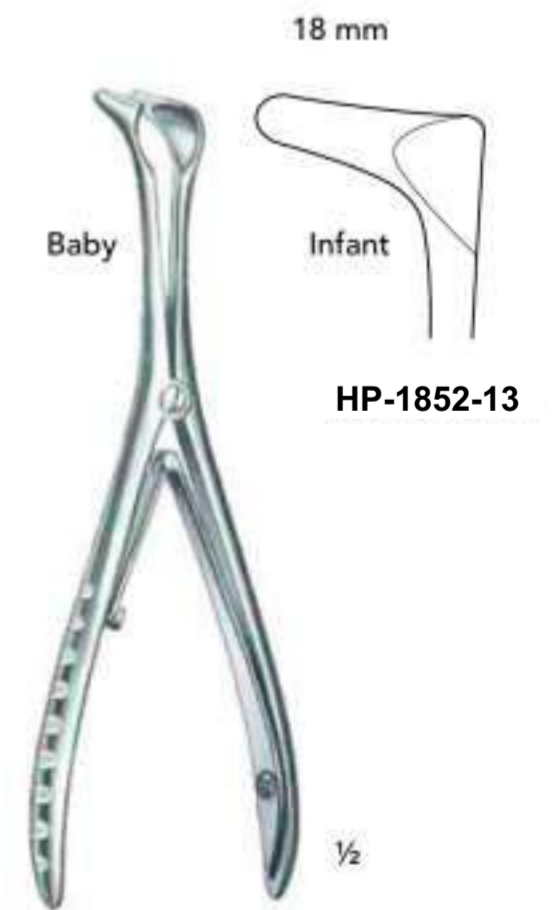

**TIECK-HALLE**  
**HP-1852-11**  
13 cm/5"

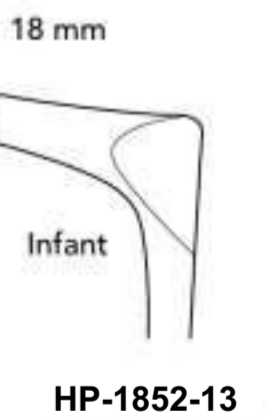

Baby

Infant

**HP-1852-13**



**KILLIAN**  
14 cm/5½"

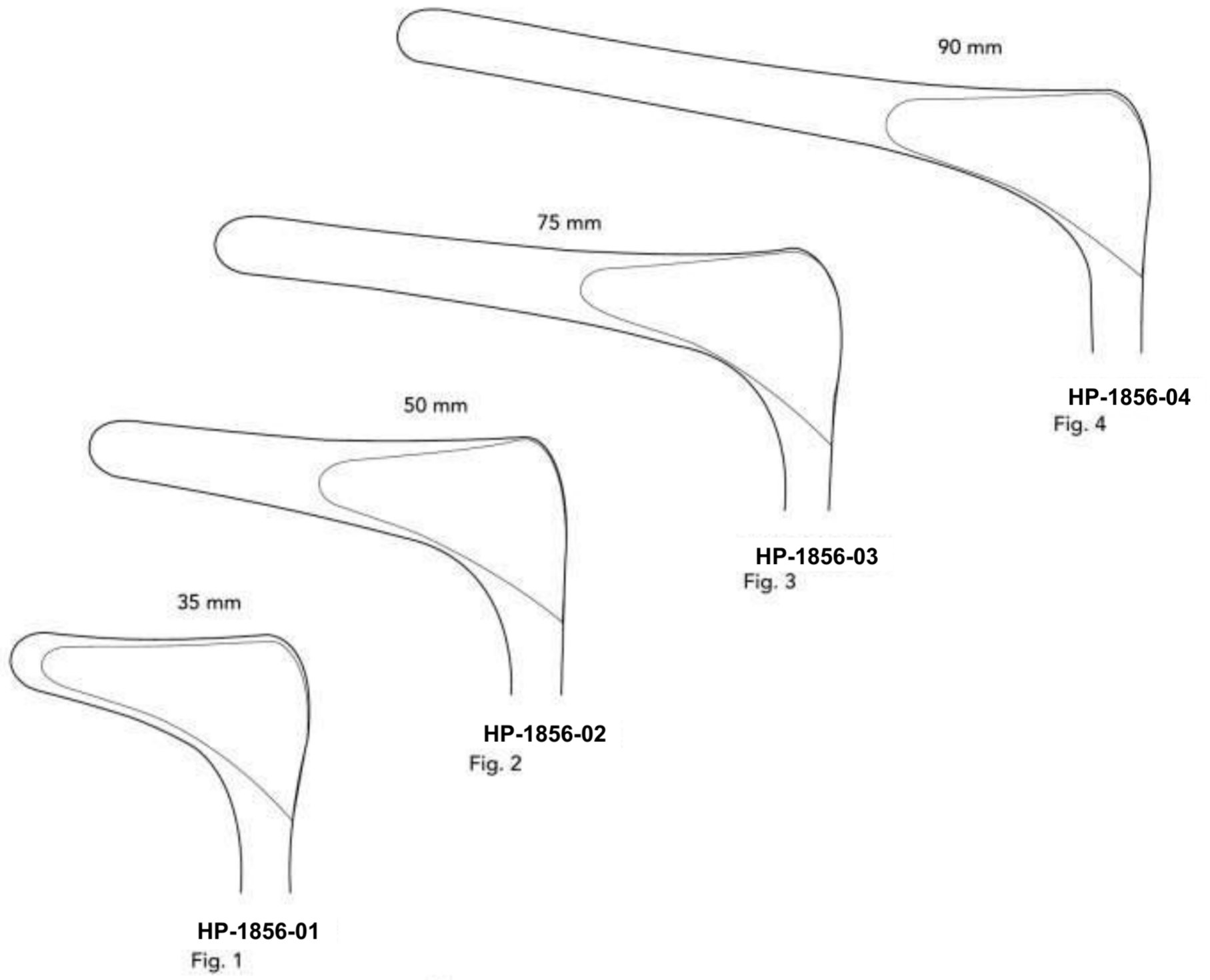

**COTTLE**  
15 cm/6"

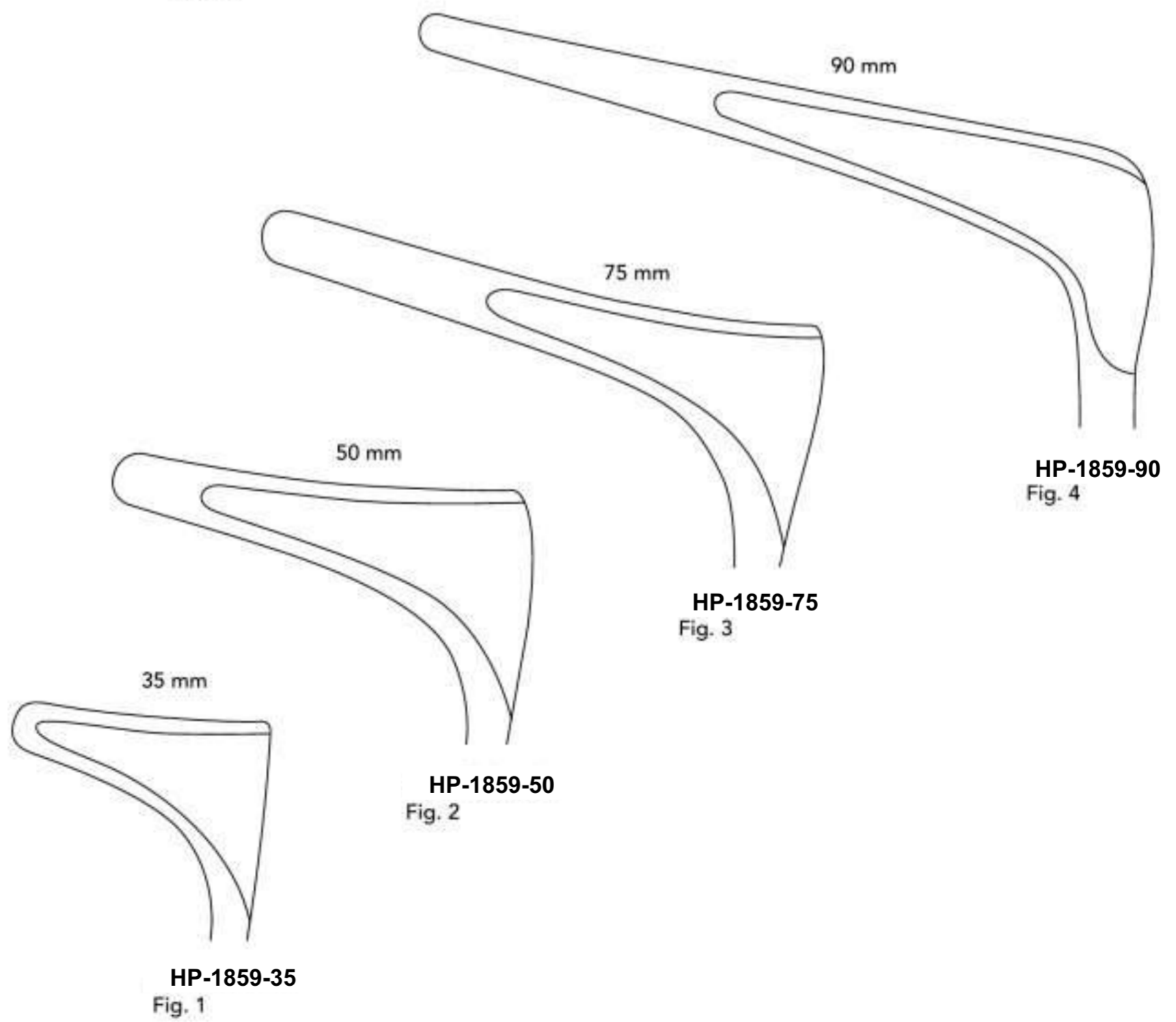



**GOLDSMITH-THUDICHUM**  
6.5 cm/2½"

18.5 x 9.5 mm

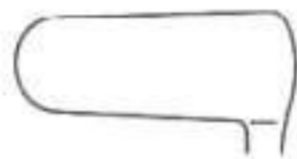

**HP-1817-01**  
Fig. 1

21.0 x 10.5 mm

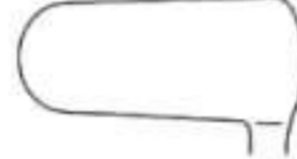

**HP-1817-02**  
Fig. 2

21.0 x 11.5 mm



**HP-1817-03**  
Fig. 3



**THUDICHUM (MARK HOVELL)**

8.5 x 6.0 mm



**HP-1818-70**  
70 mm

9.0 x 7.0 mm



**HP-1818-71**  
71 mm

12.5 x 8.0 mm



**HP-1818-72**  
72 mm

15.0 x 8.5 mm



**HP-1818-73**  
73 mm

16.5 x 9.0 mm



**HP-1818-74**  
74 mm

18.0 x 10.0 mm



**HP-1819-74**  
74 mm

19.5 x 10.6 mm

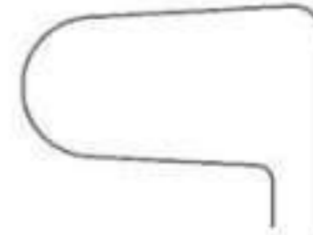

**HP-1818-75**  
75 mm



GRUENWALD (JANSEN)



TROELTSCH  
HP-1101-14  
14.5 cm/5¾"



TROELTSCH  
HP-1101-15  
15.5 cm/6"



TROELTSCH  
15 cm/6" HP-1105-15  
18 cm/7" HP-1105-18



WESTMACOTT  
HP-1121-20  
20 cm/8"



LUBET-BARBON  
HP-1129-20  
18.5 cm/7¼"



HARTMANN  
HP-1145-20  
18.5 cm/7¼"





**KNIGHT**  
HP-1207-18  
17 cm/6¾"



**GRAIG**  
HP-1213-18  
16 cm/6¼"



15.5 cm/6"



**LUC**  
20 cm/8"

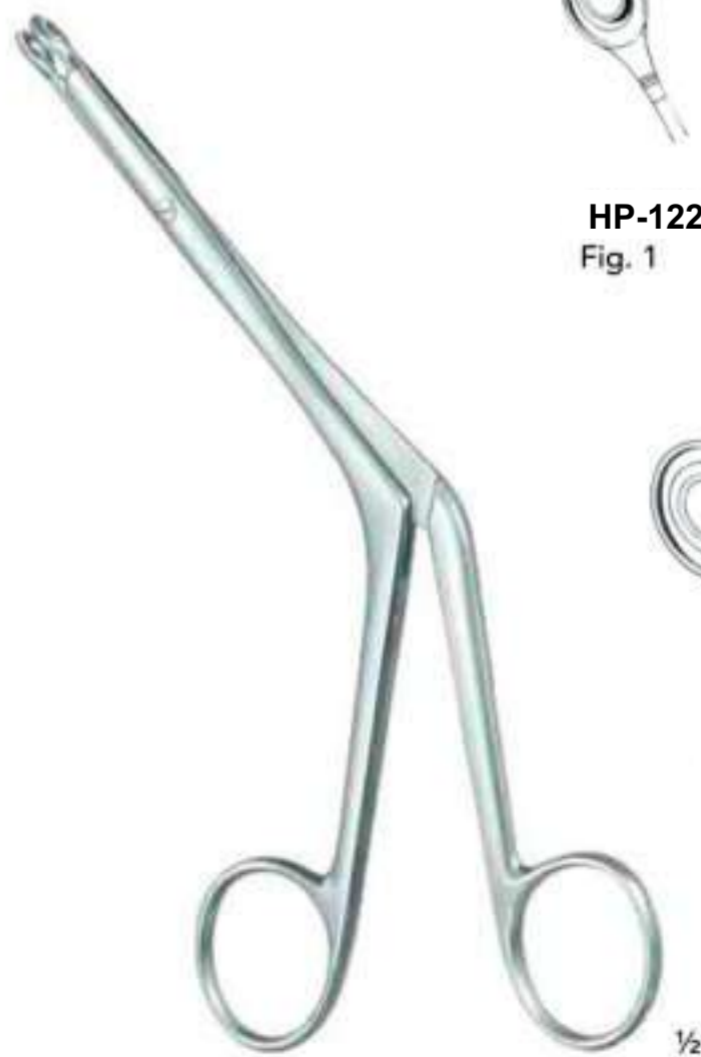

**BRUENINGS**  
16.5 cm/6½"



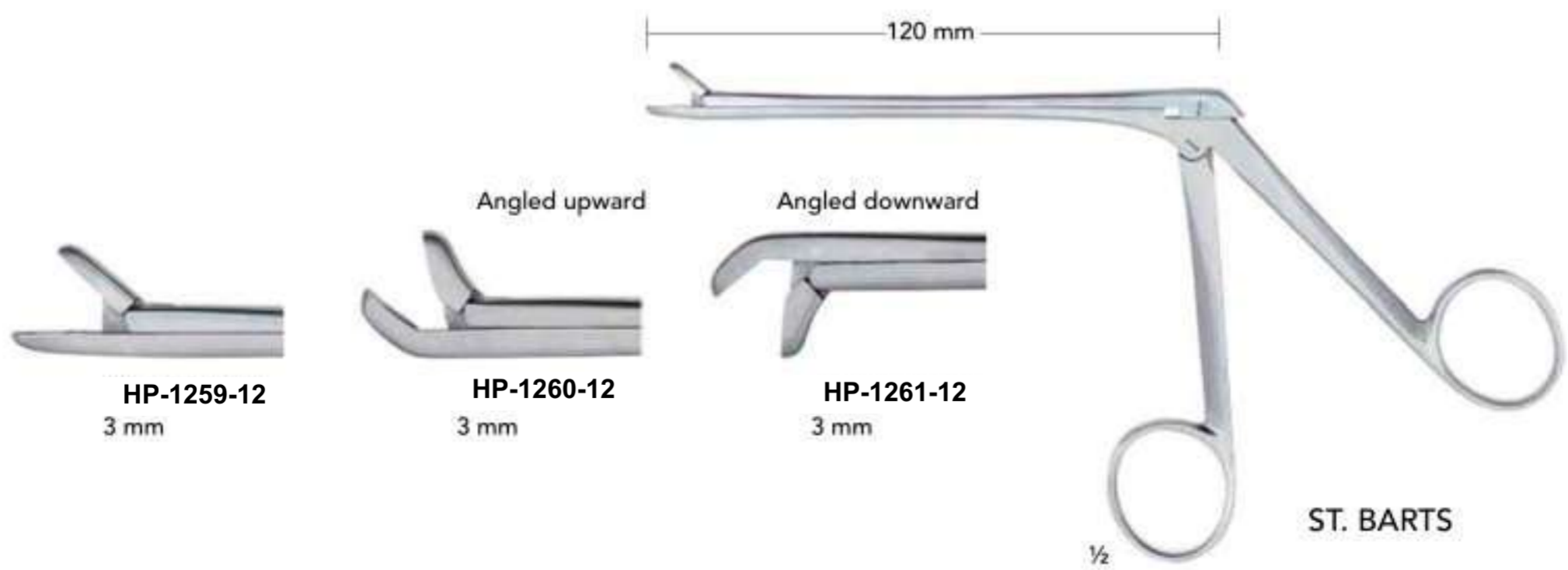
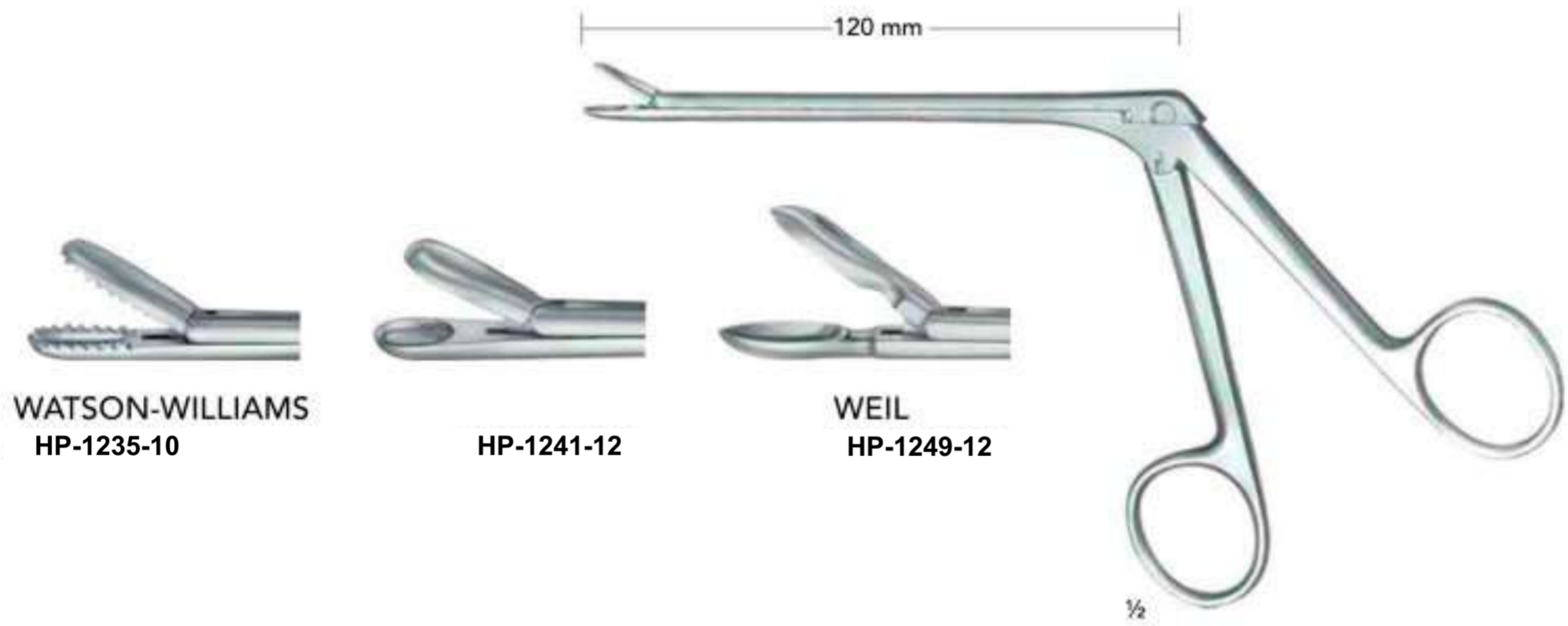
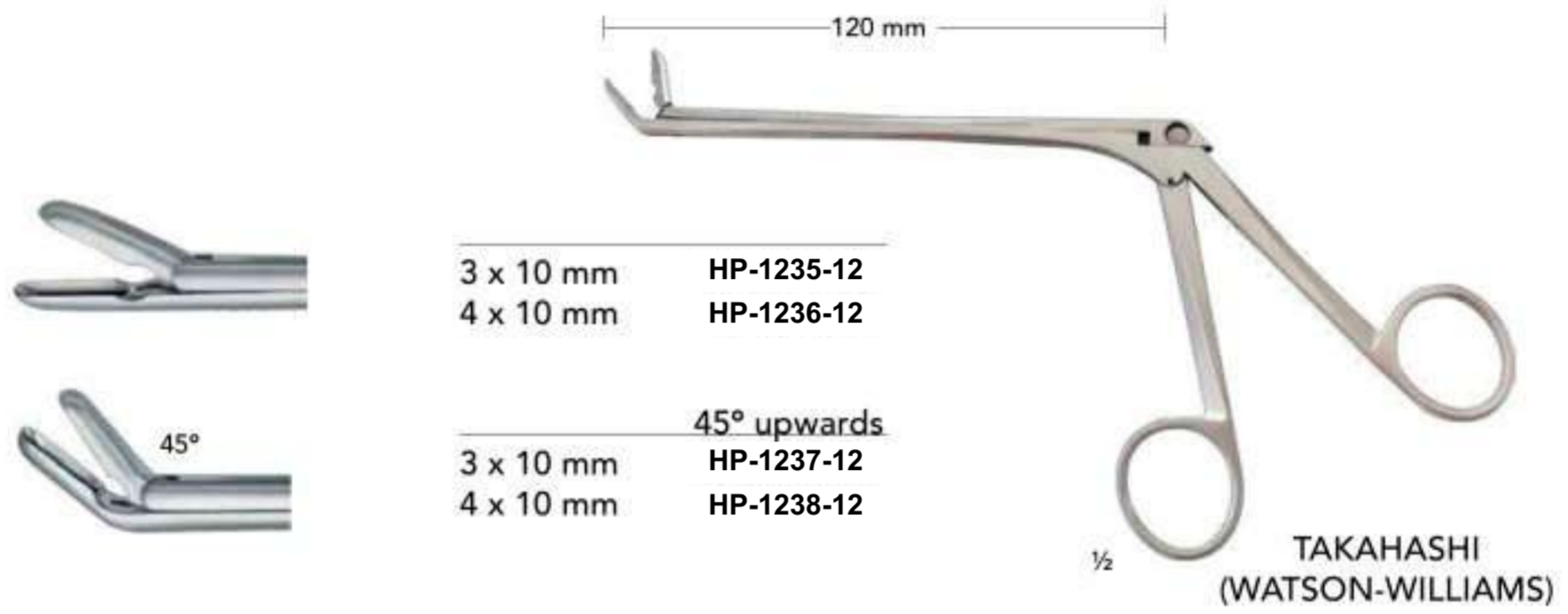

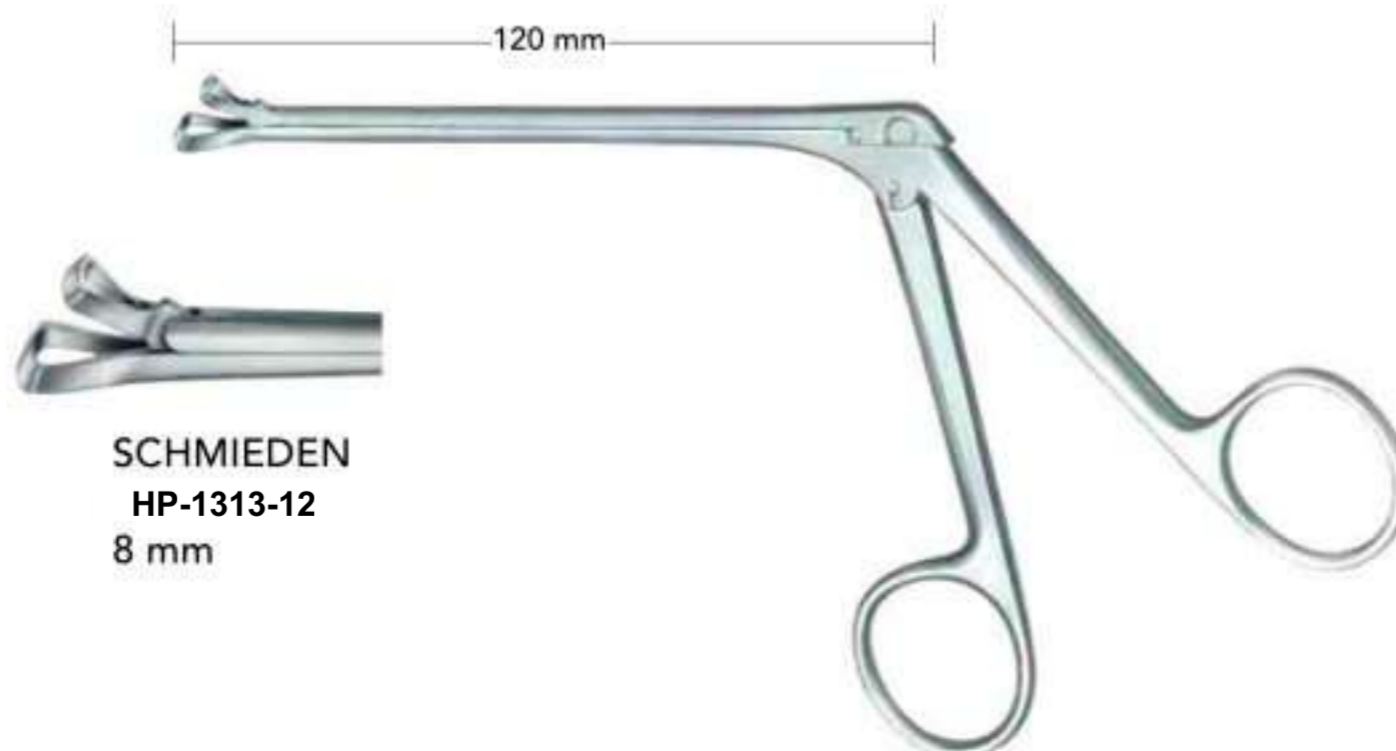
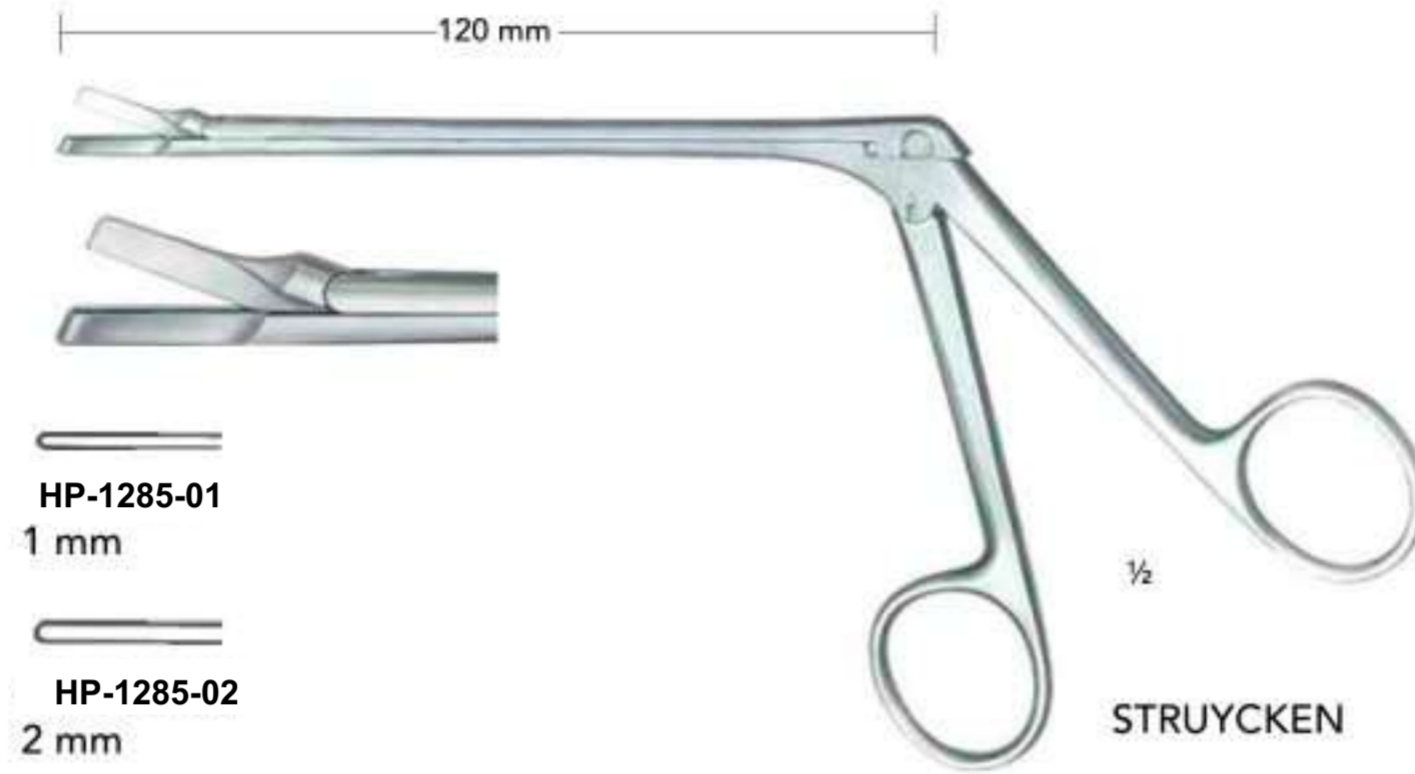

### Nasal Cutting Forceps



**VI-1255-01**  
3 mm  
Fig. 1



**VI-1255-02**  
3.5 mm  
Fig. 2



**VI-1255-03**  
4.5 mm  
Fig. 3



**VI-1255-04**  
5.5 mm  
Fig. 4



**VI-1255-05**  
6 mm  
Fig. 5



**VI-1256-01**  
3 mm  
Fig. 1



**VI-1256-02**  
3.5 mm  
Fig. 2



**VI-1256-03**  
4.5 mm  
Fig. 3



**VI-1256-04**  
5.5 mm  
Fig. 4



**VI-1256-05**  
6 mm  
Fig. 5



**VI-1258-01**  
3 mm  
Fig. 1



**VI-1258-02**  
3.5 mm  
Fig. 2



**VI-1258-03**  
4.5 mm  
Fig. 3



**VI-1258-04**  
5.5 mm  
Fig. 4



**VI-1258-05**  
6 mm  
Fig. 5



**WEIL-BLAKESLEY**

### Nasal Through Cutting Forceps



**VI-4440-01**  
3 mm  
Fig. 1



**VI-4440-02**  
3.5 mm  
Fig. 2



**VI-4440-03**  
4.5 mm  
Fig. 3



**VI-4440-04**  
5.5 mm  
Fig. 4



**VI-4440-05**  
6 mm  
Fig. 5



**VI-4441-01**  
3 mm  
Fig. 1



**VI-4441-02**  
3.5 mm  
Fig. 2



**VI-4441-03**  
4.5 mm  
Fig. 3



**VI-4441-04**  
5.5 mm  
Fig. 4



**VI-4441-05**  
6 mm  
Fig. 5



**BLAKESLEY**

180 mm

	90°	90°	40°
	upward cutting	downward cutting	downward cutting
3 mm	HP-1356-17	HP-1357-17	HP-1362-03
5 mm	HP-1360-17	HP-1361-17	HP-1362-05

1/2

**FERRIS-SMITH-KERRISON**

180 mm

	straight	angled upward	angled downward
2 x 10 mm	VI -1364-02	VI -1365-02	VI -1367-02
3 x 10 mm	VI -1364-03	VI -1365-03	VI -1367-03
4 x 10 mm	VI -1364-04	VI -1365-04	VI -1367-04
5 x 10 mm	VI -1364-05	VI -1365-05	VI -1367-05
6 x 10 mm	VI -1364-06	VI -1365-06	VI -1367-06

30°

1/2

140 mm

90° up	90° down
HP-1342-12	HP-1342-13
3.5 x 3.5 mm	3.5 x 3.5 mm

**HAJEK-KOFLER**

90° up	90° down
HP-1343-12	HP-1343-13
4 x 4 mm	4 x 4 mm

**HAJEK**

1/2



**KRAUSE**  
HP-1885-26  
26 cm/10¼"



**KRAUSE-VOSS**  
HP-1887-26  
26 cm/10¼"

Snare wire, coil of 10 m



½  
Ø 0.3 mm HP-1898-30  
Ø 0.4 mm HP-1898-40



Snare Wire

½  
**HP-1899-12**  
Ø 0.3 mm  
Bundle with 12 pieces

Through-cutting

TC Jaws

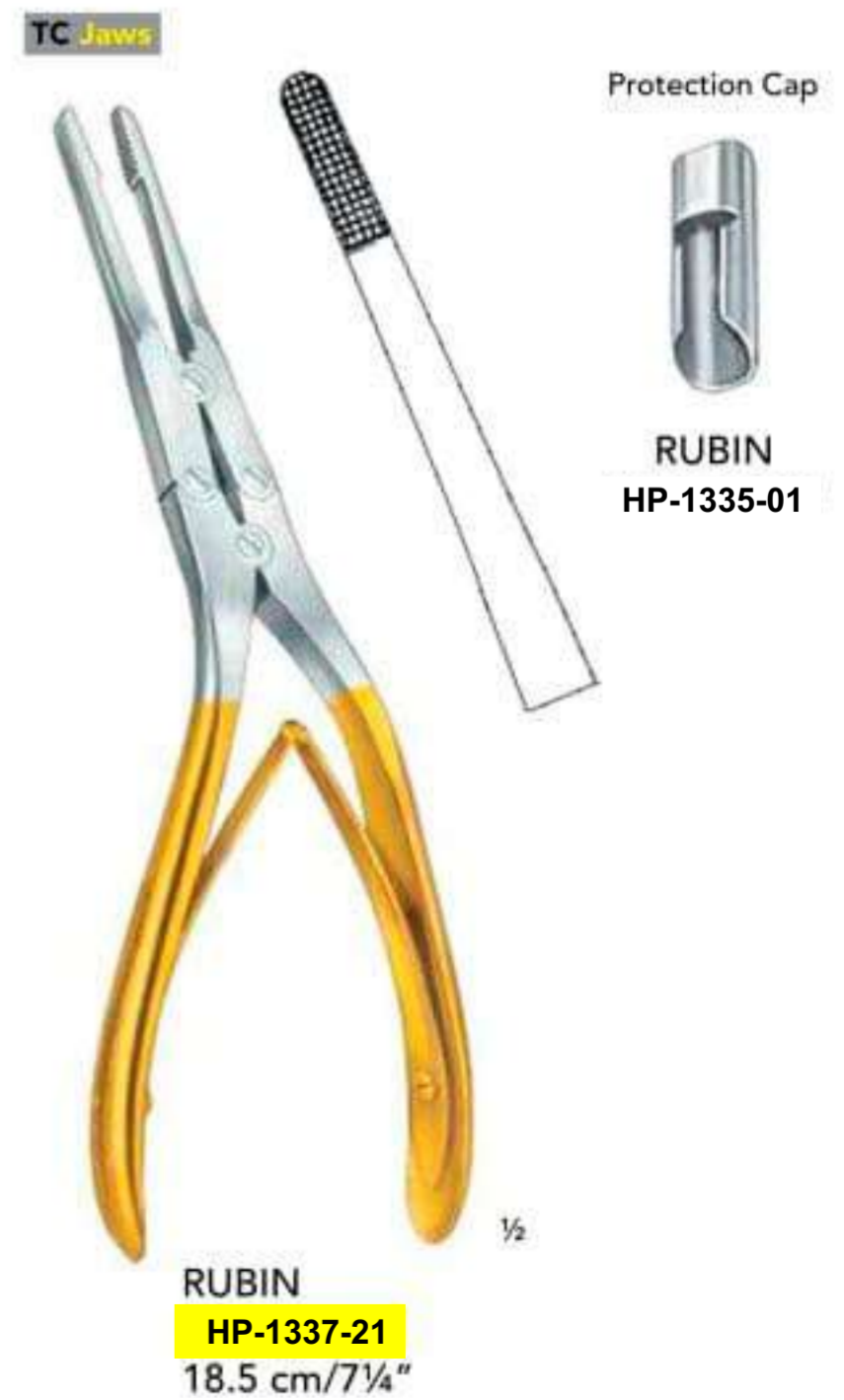

One toothed cutting edge



**CAPLAN**  
HP-1331-20  
20 cm/8"

Longitudinal Jaw

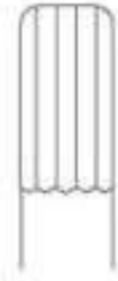

HP-1500-18

TC Jaws

Morselizer Jaw



HP-1501-18



**GUNTER**  
18 cm/7"

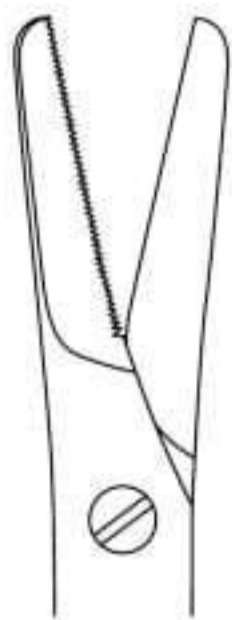

TC Edge



**CAPLAN**  
HP-1799-21  
21 cm/8¼"

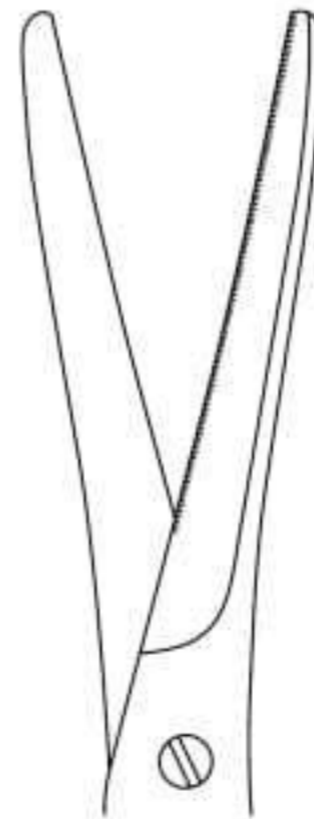

TC Edge

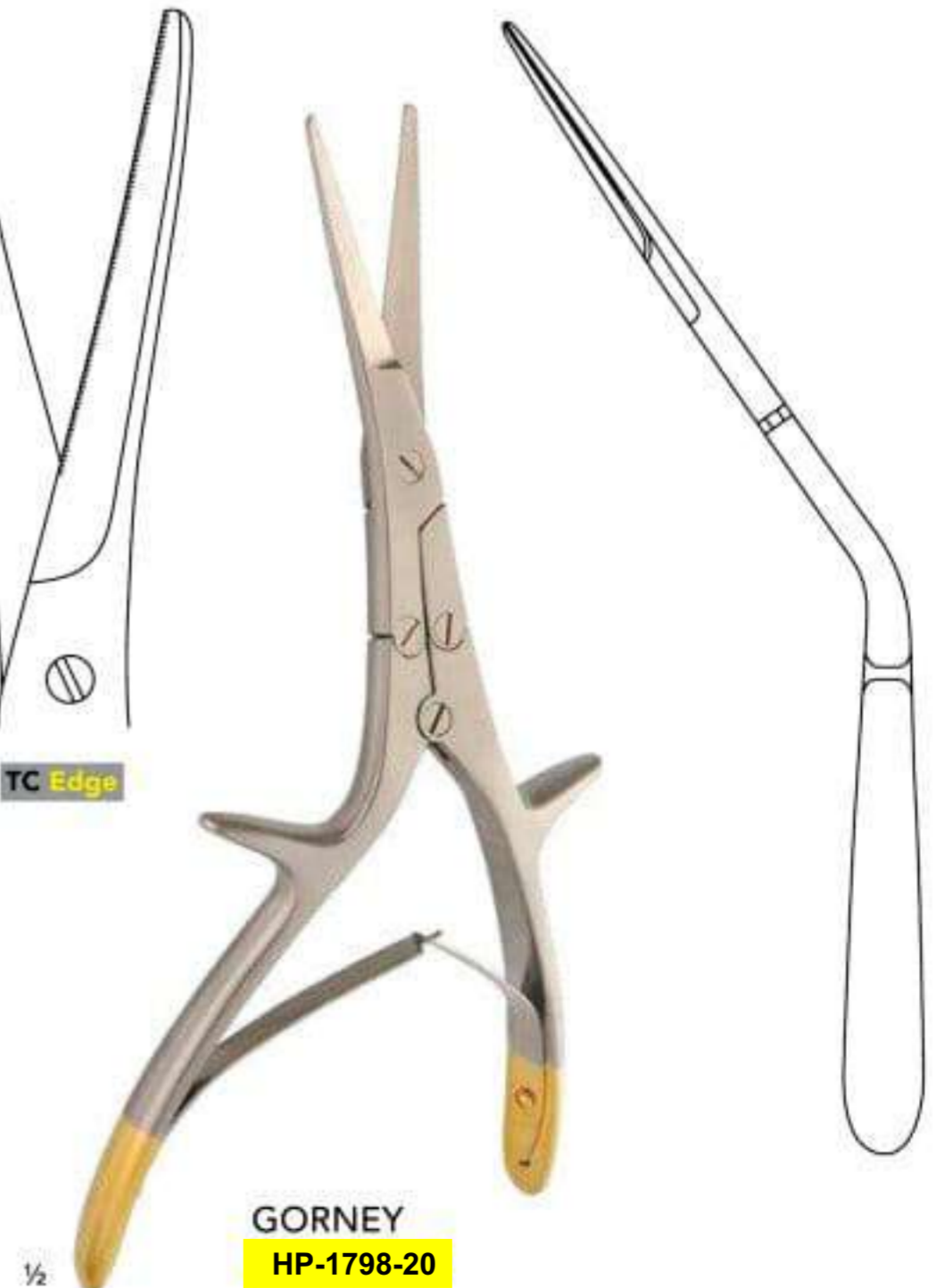

**GORNEY**  
HP-1798-20  
20.5 cm/8"



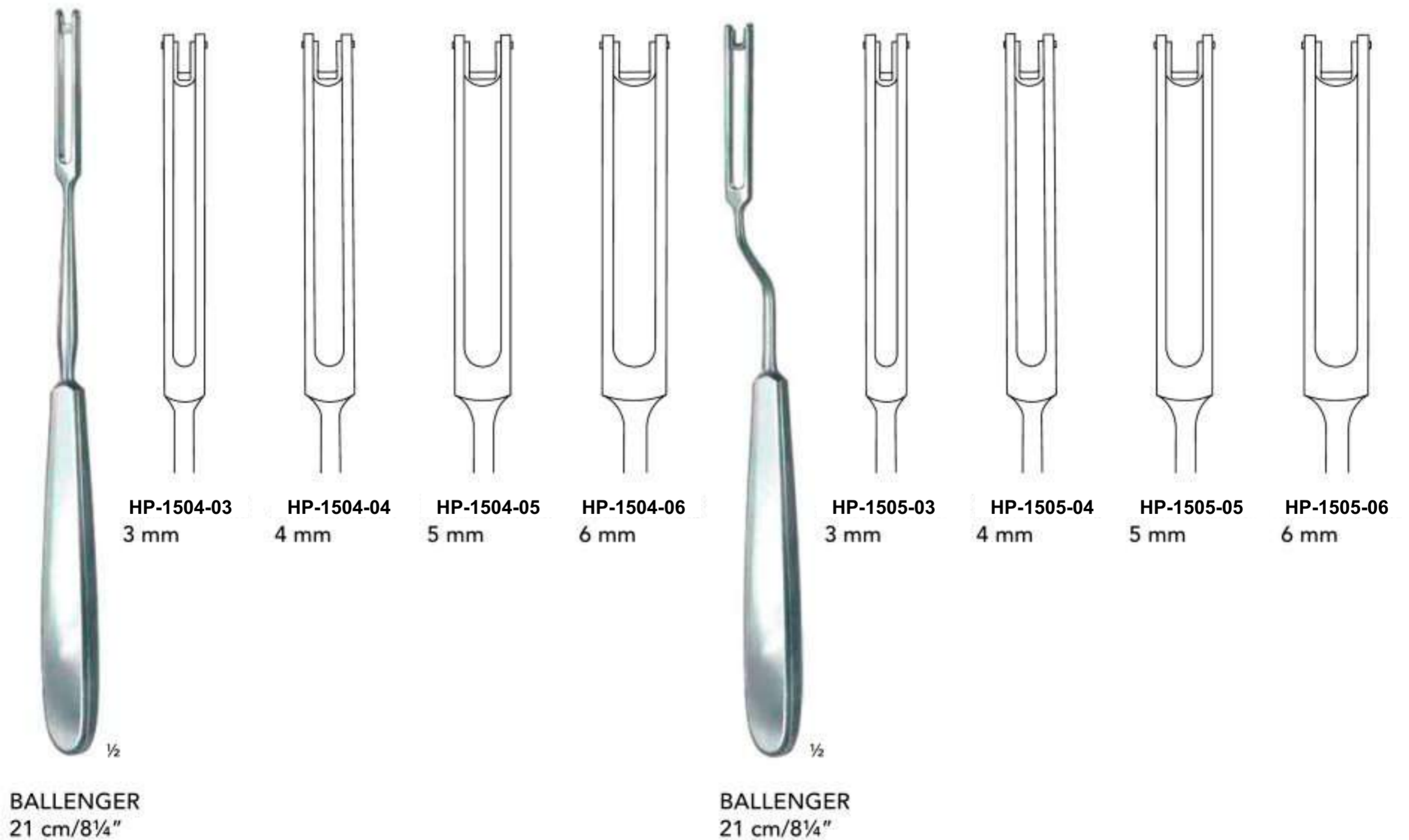
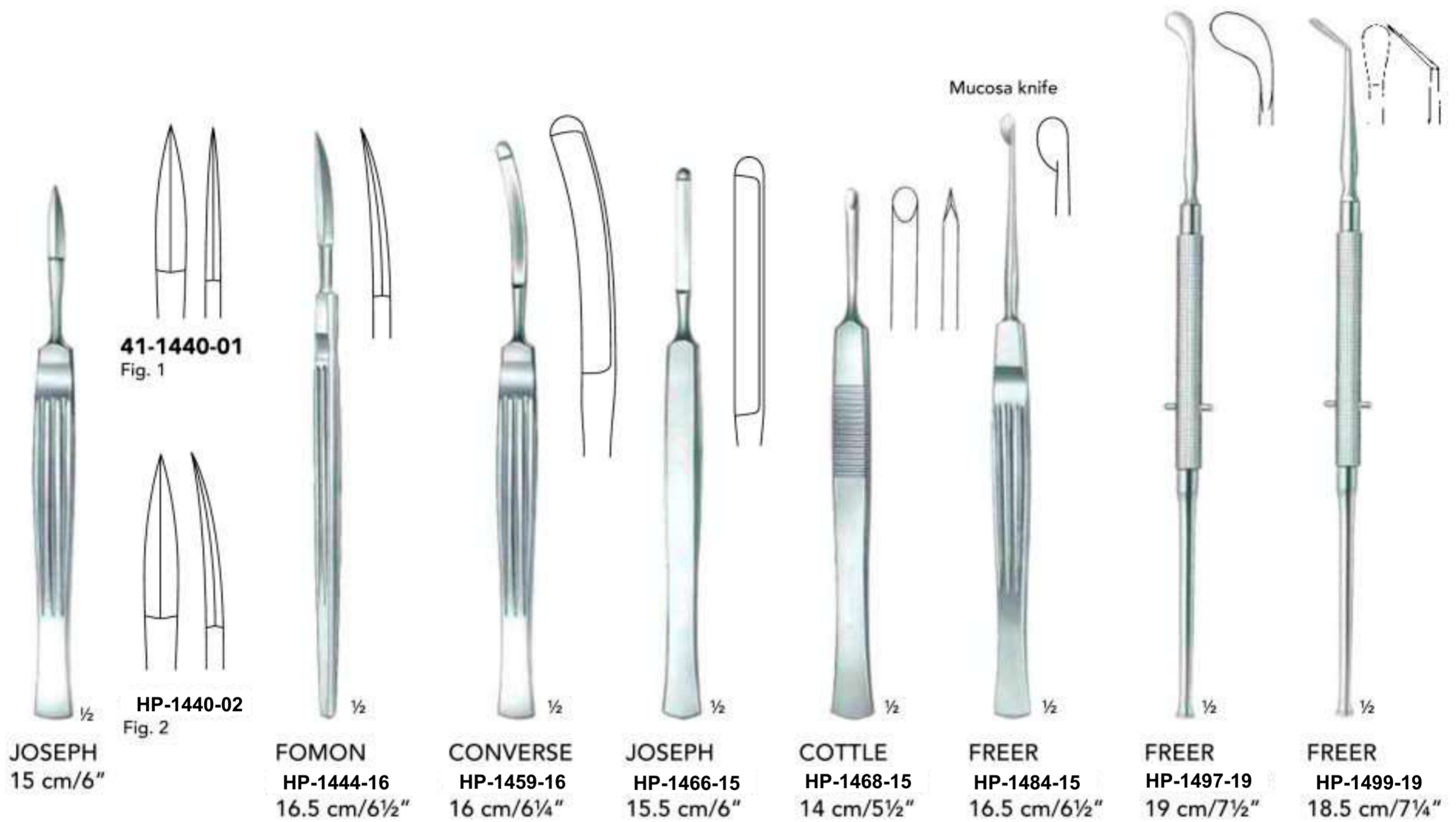

Rhinology

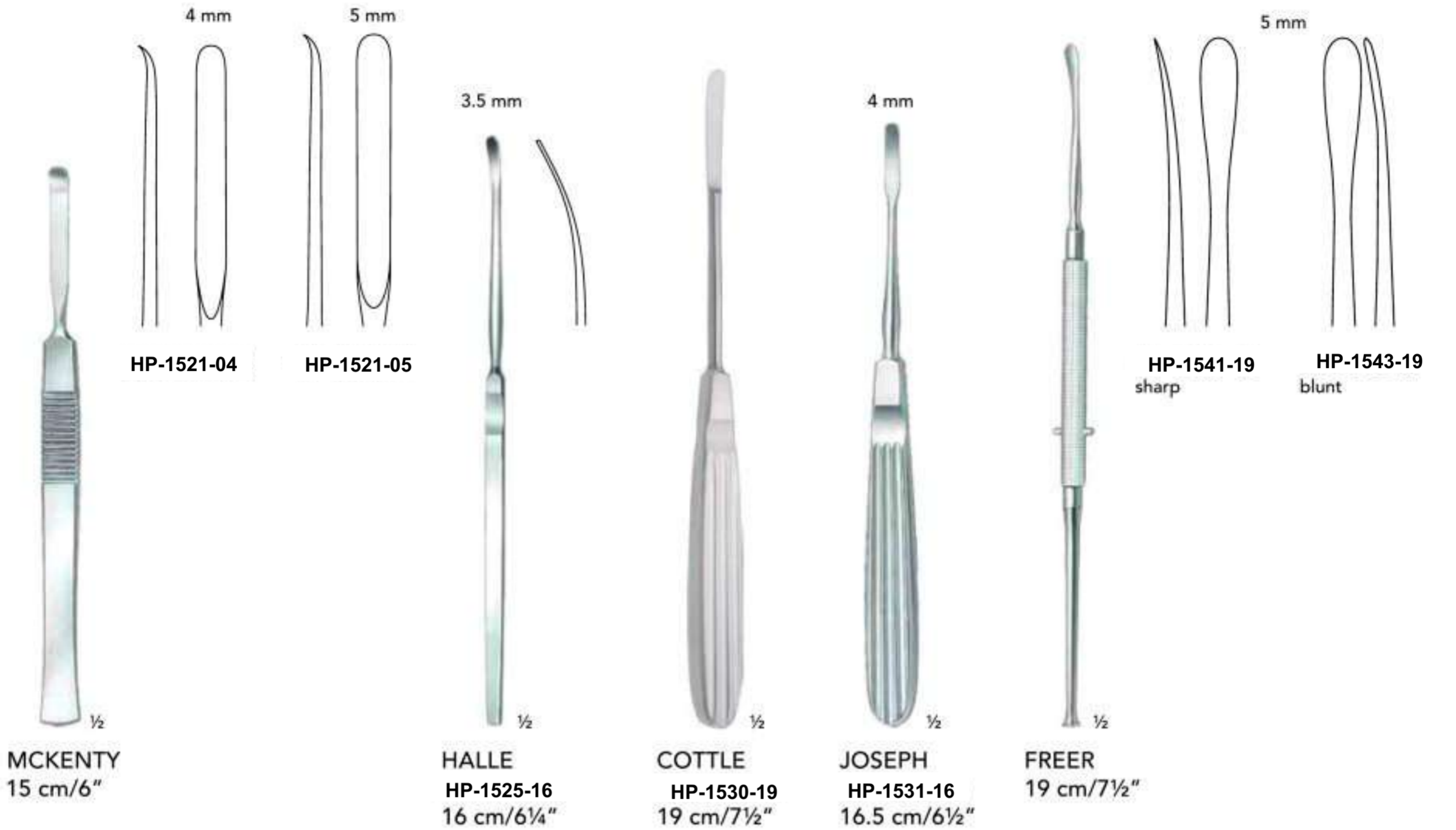

Cleft Palate Periosteal Raspatory

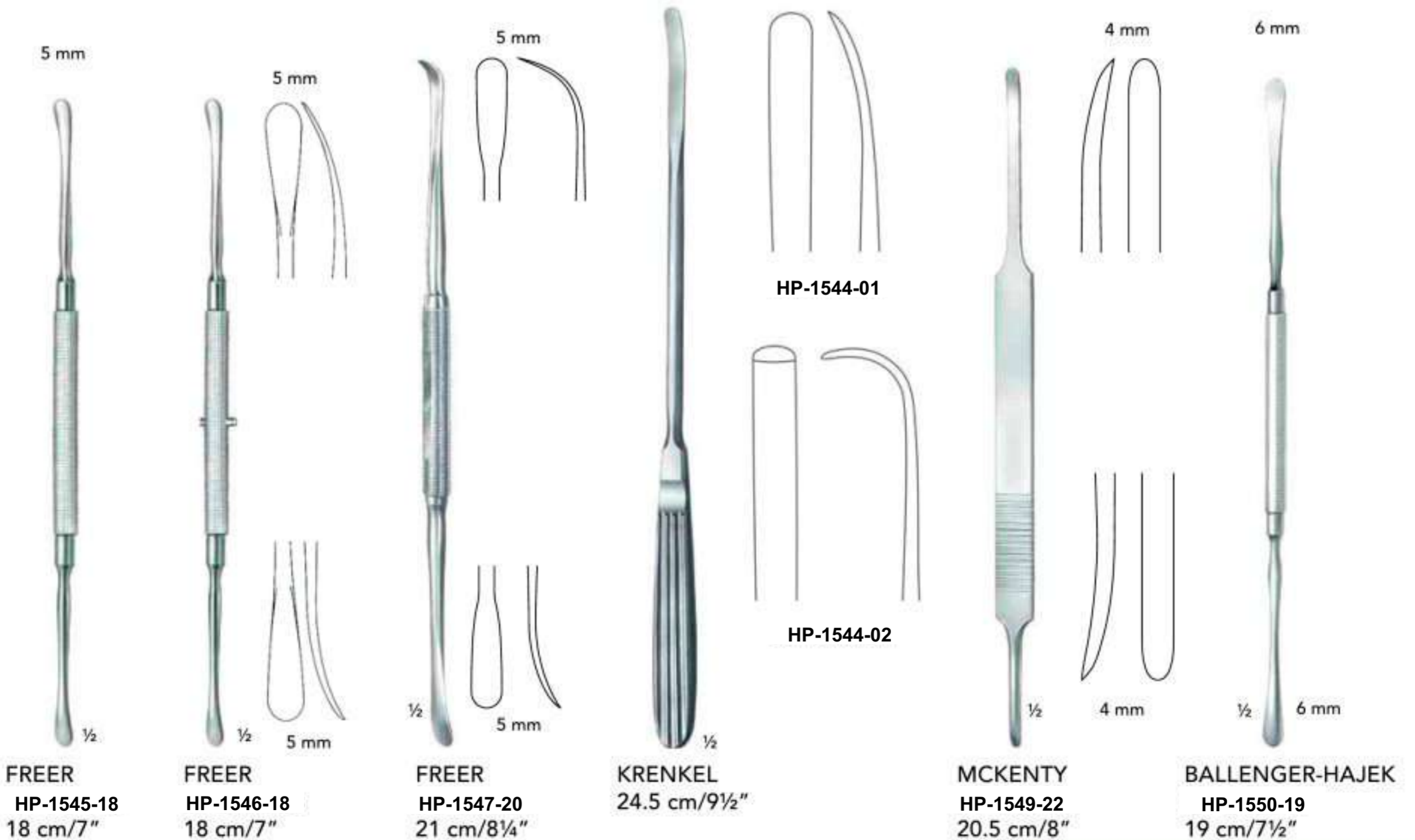



**HOWARD**  
HP-1557-22  
21.5 cm/8½"



**COTTLE**  
HP-1559-23  
23.5 cm/9¼"

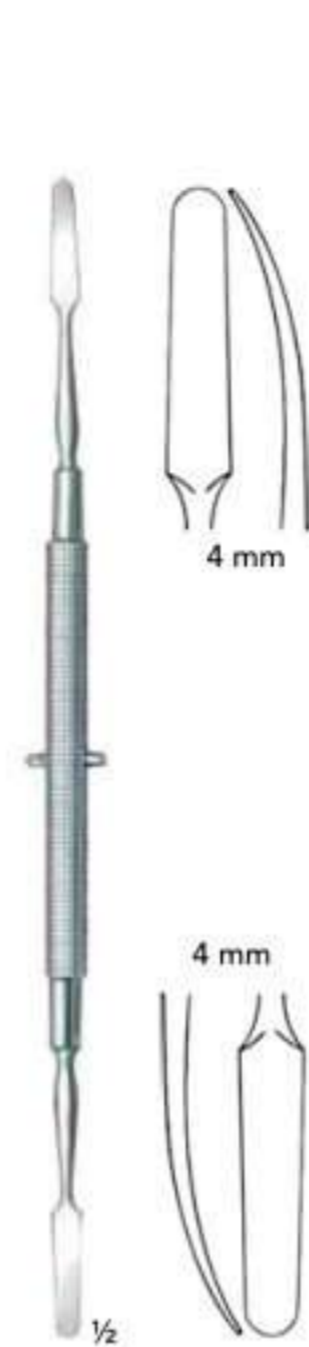

**KILLIAN**  
HP-1560-18  
18 cm/7"



**KILLIAN**  
HP-1562-22  
23.5 cm/9¼"



**PENNINGTON**  
HP-1568-21  
21 cm/8"



**ROGER**  
HP-1572-19  
19 cm/7½"



**JOSEPH-MASING**  
HP-1579-22  
21.5 cm/8½"

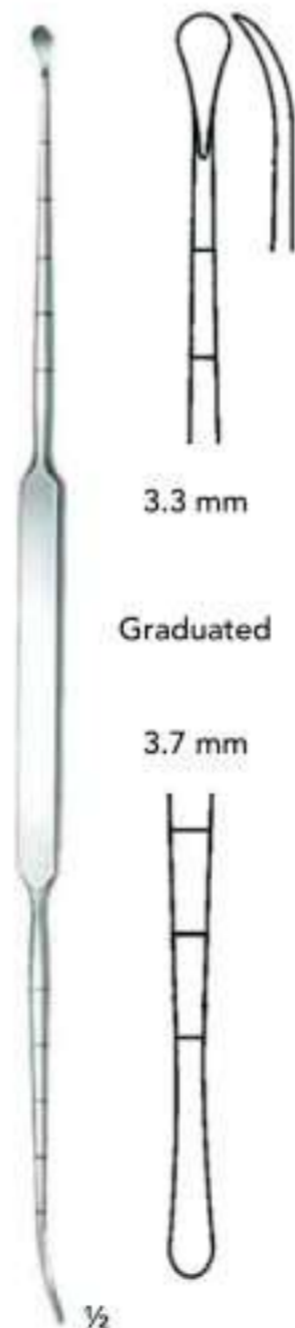

**COTTLE**  
HP-1581-22  
23 cm/9"

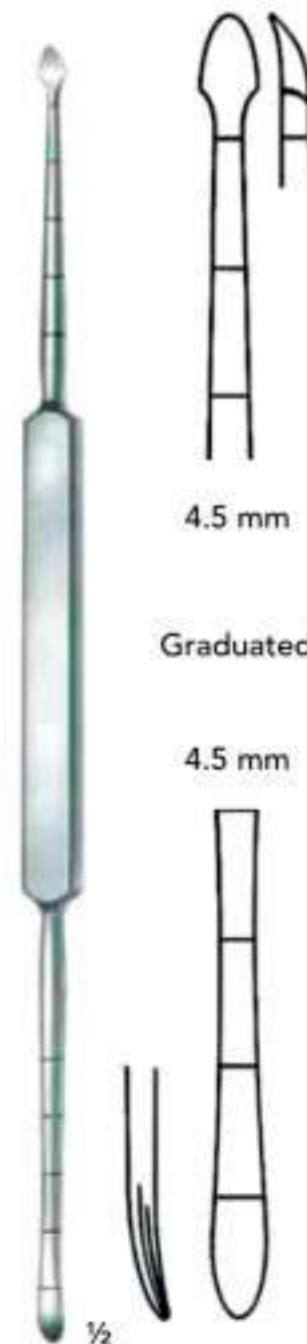

**COTTLE**  
HP-1585-22  
23 cm/9"



**JOSEPH**  
HP-1585-16  
18 cm/7"

## Rhinology

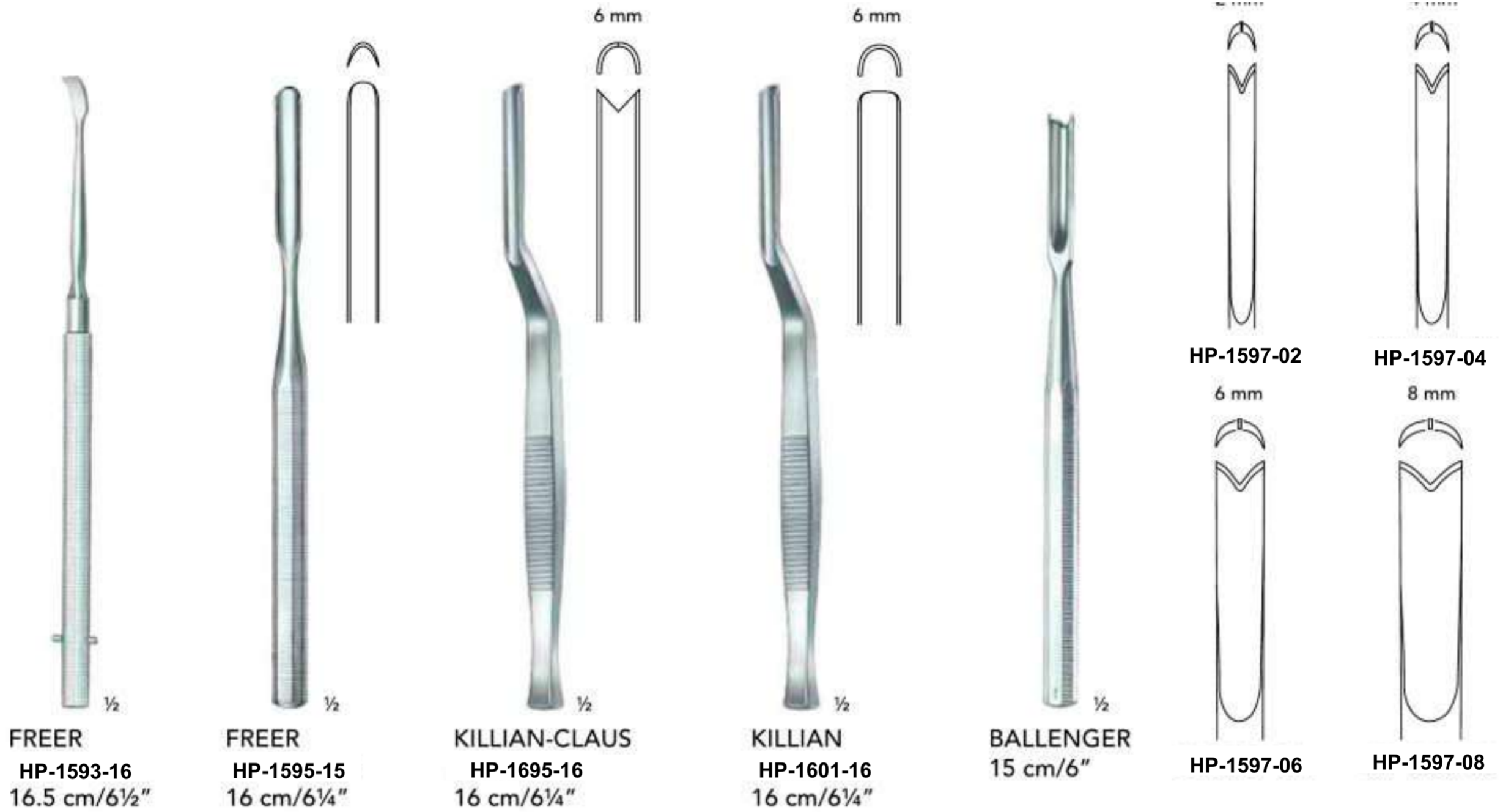

2 mm	VI -1626-02	9 mm	VI -1626-09
3 mm	VI -1626-03	10 mm	VI -1626-10
4 mm	VI -1626-04	11 mm	VI -1626-11
5 mm	VI -1626-05	12 mm	VI -1626-12
6 mm	VI -1626-06	13 mm	VI -1626-13
7 mm	VI -1626-07	14 mm	VI -1626-14
8 mm	VI -1626-08	15 mm	VI -1626-15



6 mm	VI -1616-06
8 mm	VI -1616-08
10 mm	VI -1616-10
11 mm	VI -1616-11
12 mm	VI -1616-12
14 mm	VI -1616-14
16 mm	VI -1616-16



2 mm	VI -1606-02
4 mm	VI -1606-04
6 mm	VI -1606-06
7 mm	VI -1606-07
8 mm	VI -1606-08
9 mm	VI -1606-09
10 mm	VI -1606-10
12 mm	VI -1606-12

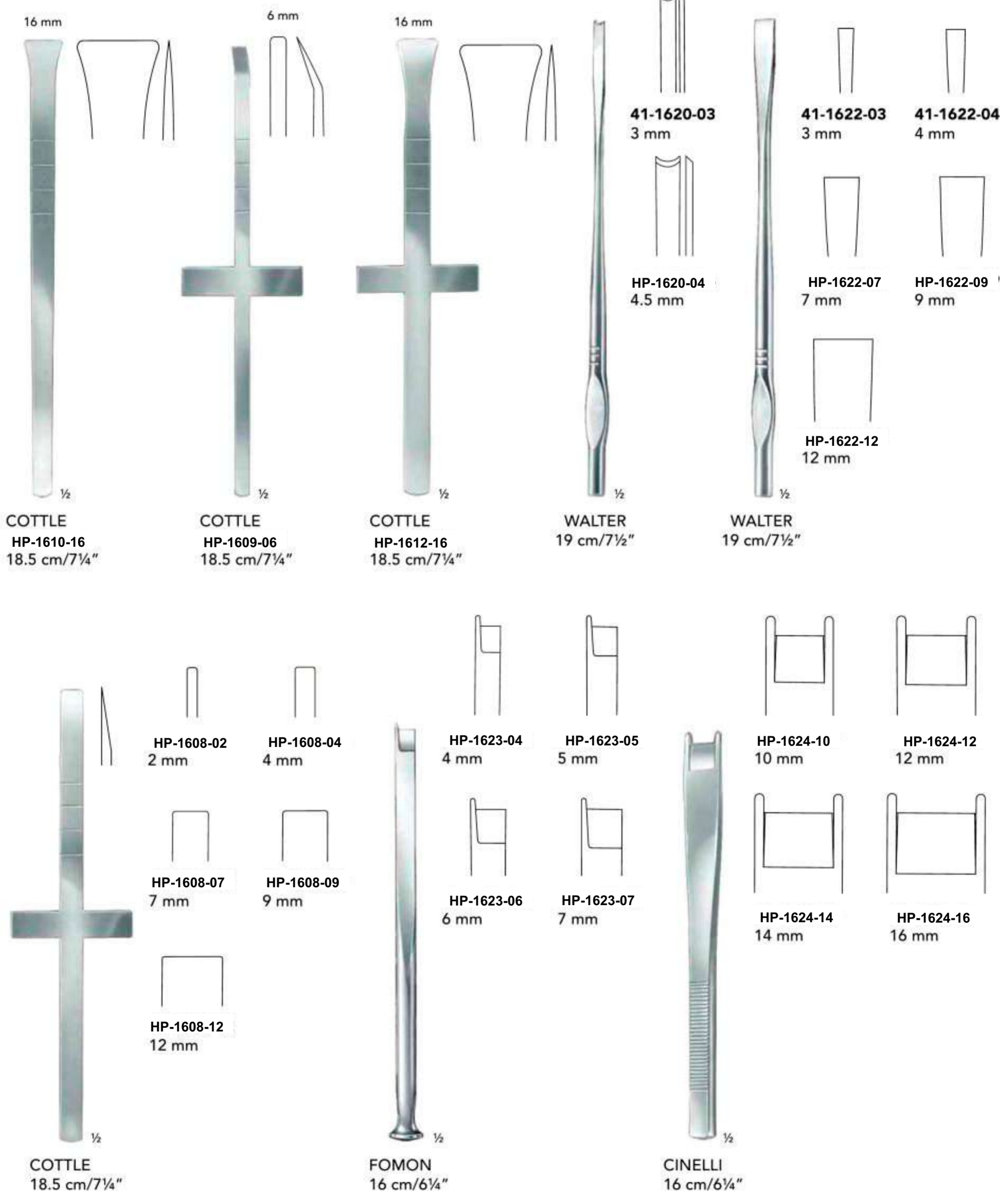

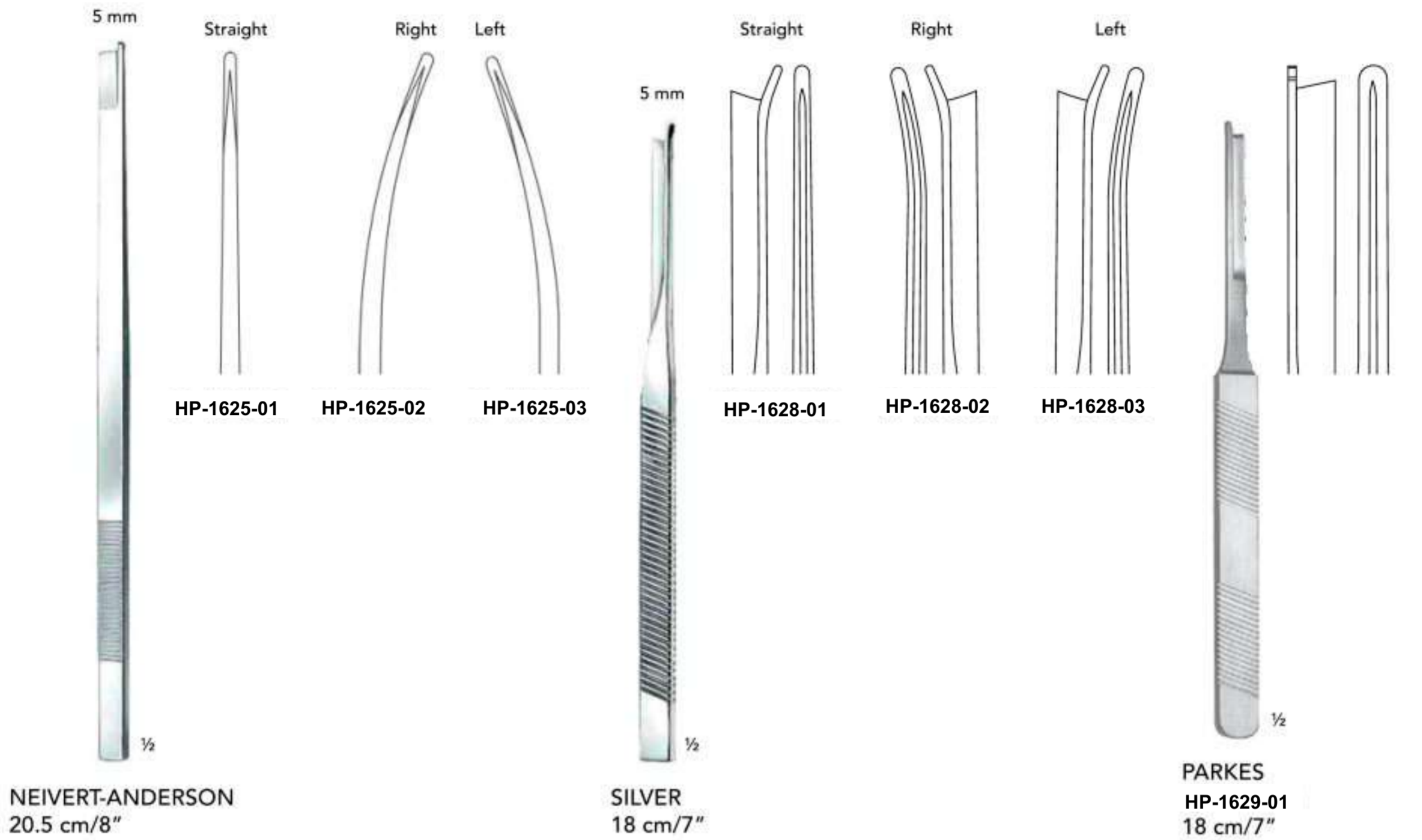

Nasal Saws

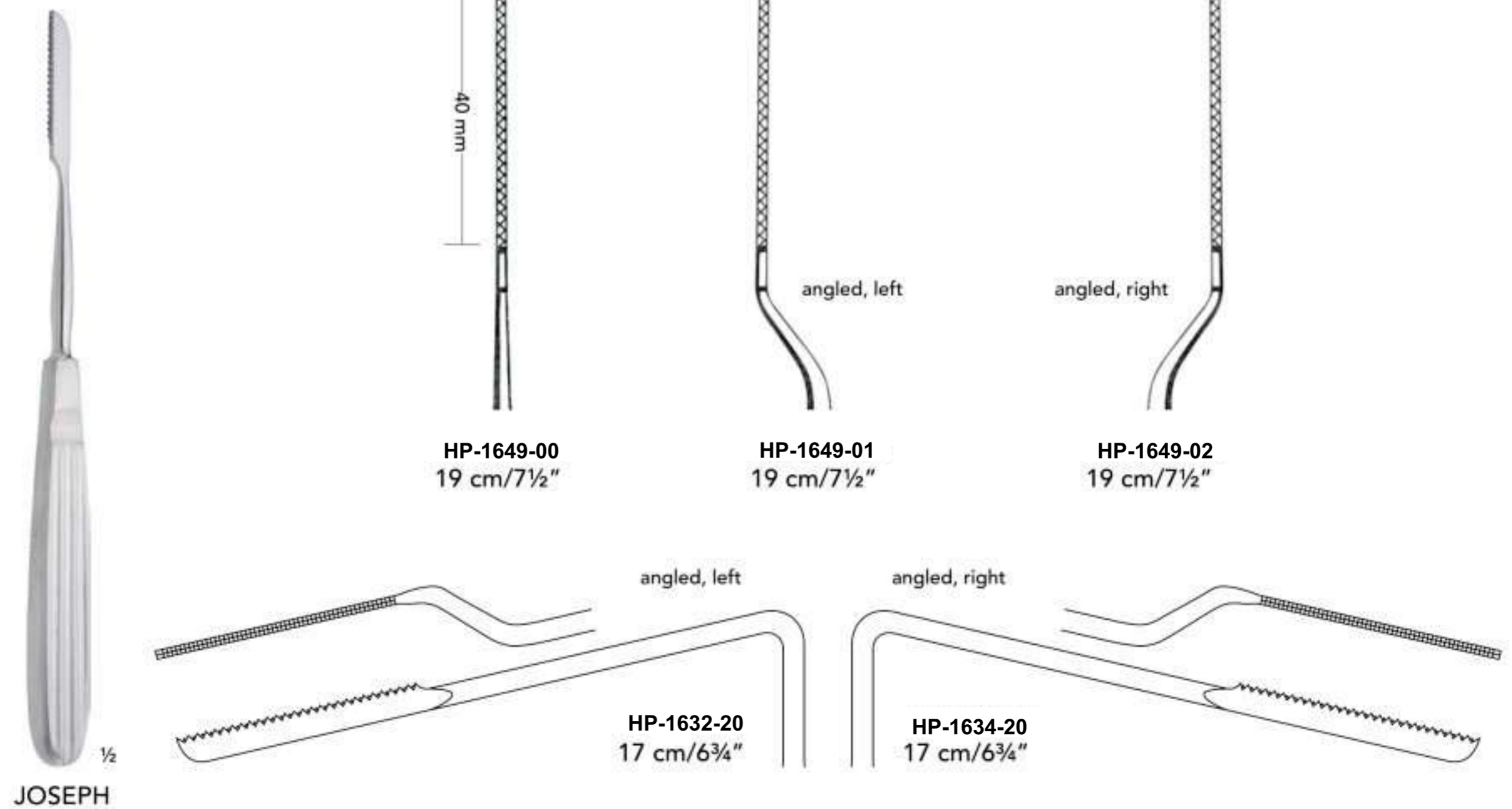

Drawing cut

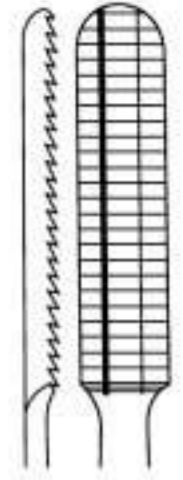

HP-1656-01

Pushing cut

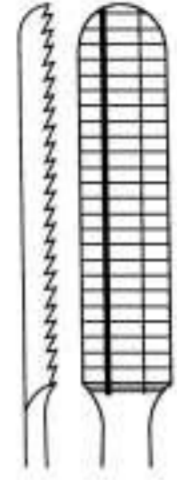

HP-1656-02



**MALTZ**  
17 cm/6¾"

Pushing cut

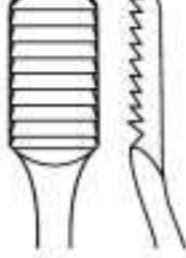

HP-1674-18

Drawing cut

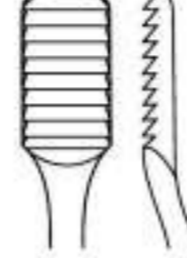

HP-1676-18



**LEWIS**  
19 cm/7½"

45 x 6 mm



HP-1669-02



HP-1669-03



HP-1669-01



**GALLAHER**  
17 cm/6¾"

34 x 8 mm

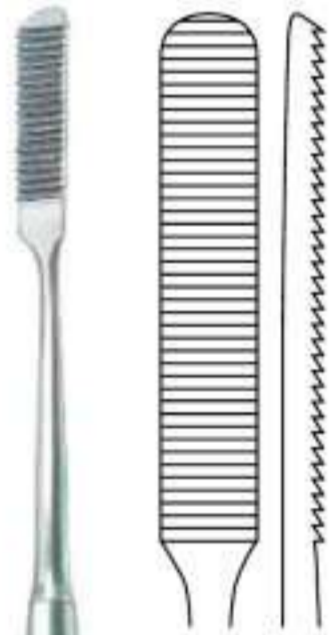

**COTTLE**  
HP-1670-21  
21 cm/8¼"

32 x 9 mm

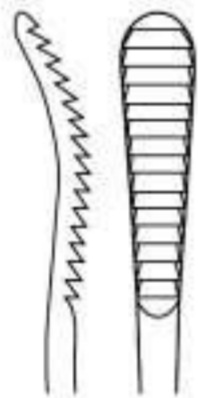

HP-1671-21

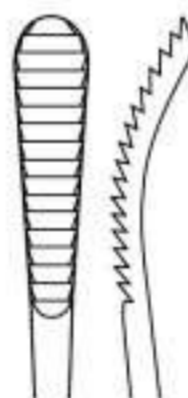

HP-1673-21



**AUFRICHT**  
21 cm/8¼"



**AUFRICHT (GLABELLA)**  
20 cm/8"

	Downward	Upward
4 mm	HP-1674-04	HP-1675-04
7 mm	HP-1674-07	HP-1675-07

TC Jaws



**AUFRICHT (GLABELLA)**

HP-1800-21  
21 cm/8¼"

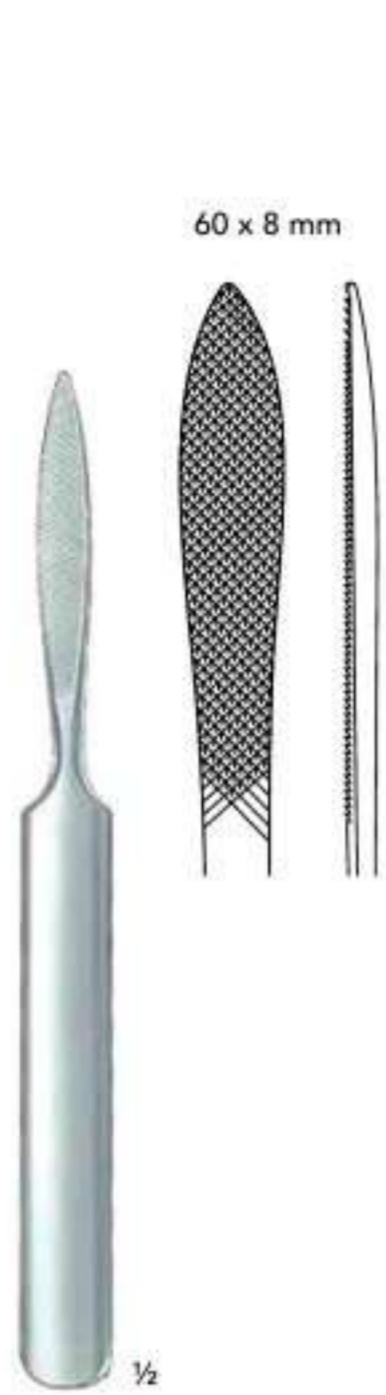

**JOSEPH**  
**HP-1685-01**  
 16 cm/6¼"

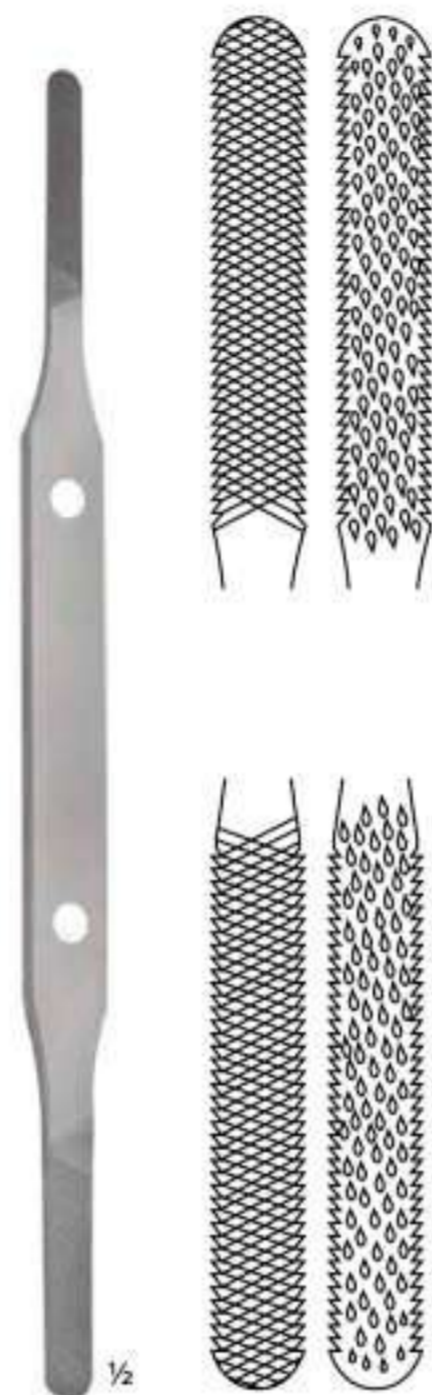

**FOMON**  
 21.5 cm/8½"  
 Fine                      Coarse  
**HP-1684-21      HP-1685-21**

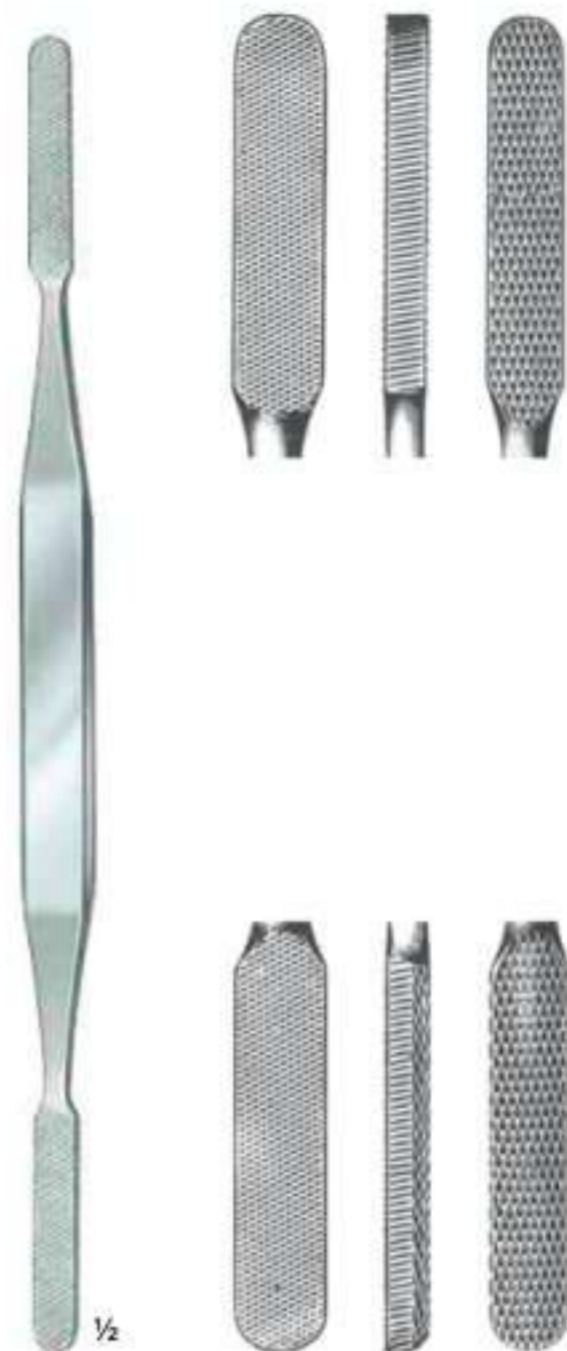

**FOMON**  
**HP-1680-21**  
 20.5 cm/8"



Cartilage Crusher

**COTTLE**

Smooth Bed                      **HP-1652-00**  
 Serrated Bed                      **HP-1652-01**



**TOLSDORF**

Smooth Bed                      **HP-1653-00**  
 Serrated Bed                      **HP-1653-01**

Guide Support for osteotomes



**COTTLE**  
**HP-1650-02**  
 7 mm



Handle for  
**HP-1650-01**

**COTTLE**  
**HP-1650-01**  
 12 cm/4¾"



TC Jaws



1/2  
FOMON  
20 cm/8"

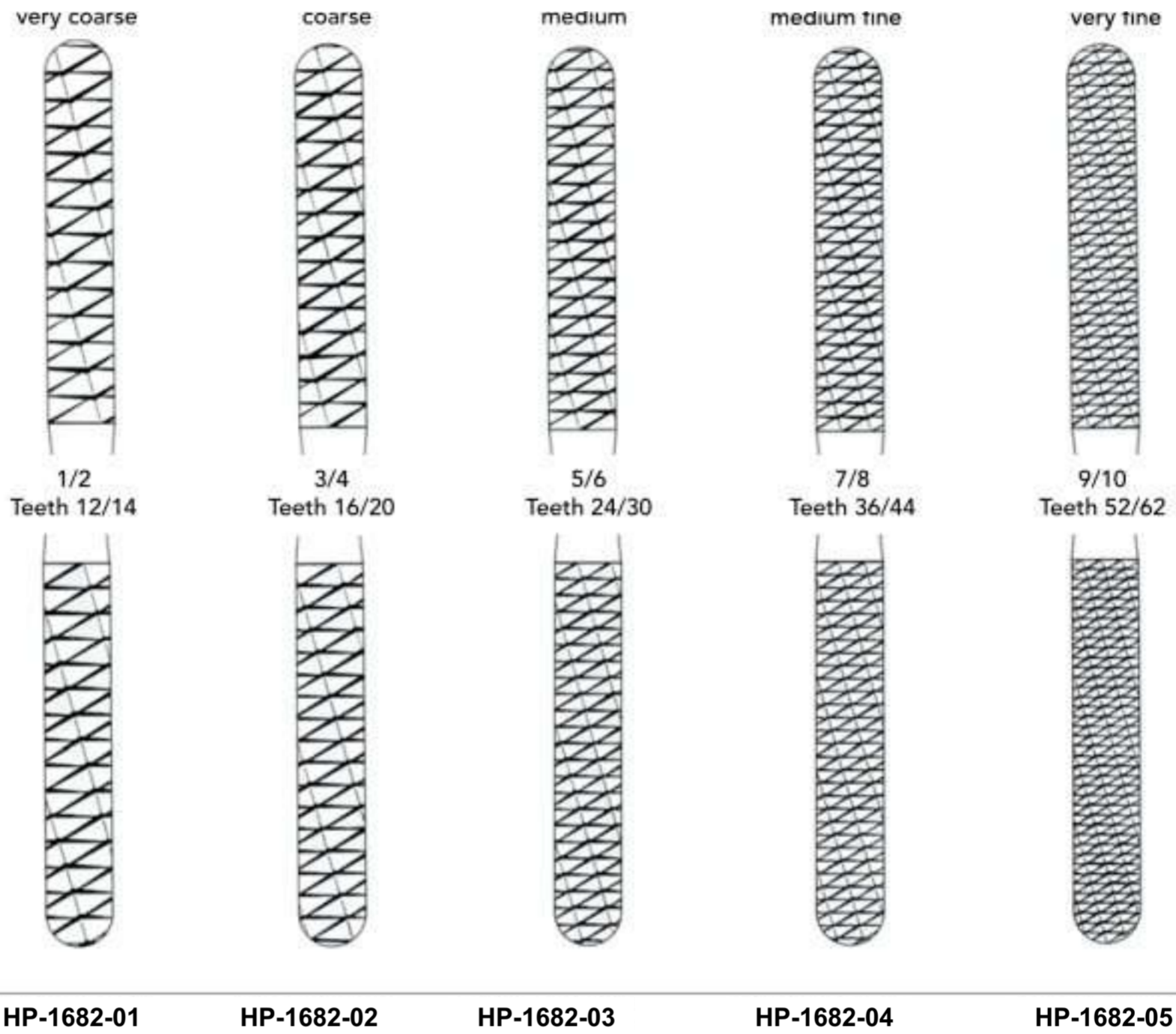

TC Jaws



1/2  
PARKES  
21 cm/8 1/4"

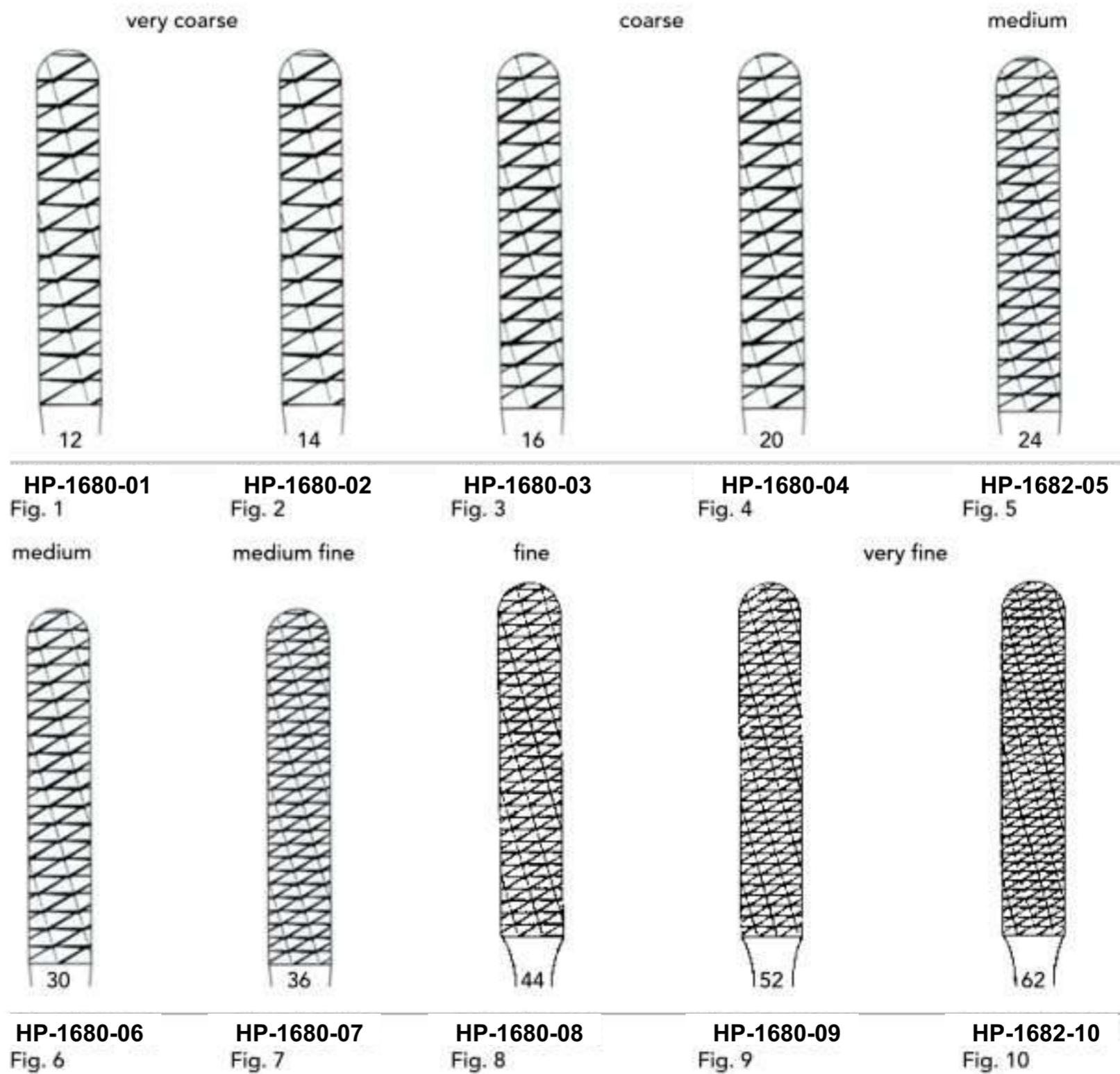

Alar Hooklet, button end

Mucosa Hooklet, sharp

sharp

sharp

HP-1684-15  
15.5 cm/6"

HP-1686-16

180°

HP-1686-17

HP-1688-01  
Fig. 1

HP-1688-02  
Fig. 2

HP-1688-03  
Fig. 3

45 x 11 mm

sharp

sharp

JOSEPH  
HP-1684-15  
15.5 cm/6"

COTTLE  
17 cm/6¾"

COTTLE  
17 cm/6¾"

LANGE  
HP-1692-22  
23 cm/9"

AUFRICHT  
HP-1697-19  
19 cm/7½"

KILNER  
HP-1698-10  
8 cm/3¼"

44 x 11 mm

10 mm

14 mm

HP-1704-01  
1 mm

HP-1704-02  
2 mm

HP-1704-05  
5 mm

HP-1704-07  
7 mm

HP-1704-10  
10 mm

2 buttoned end

HP-1694-17  
17 cm/6¾"

CONVERSE  
HP-1699-11  
10.5 cm/4¼"

CONVERSE  
12 cm/4¾"

Sharp HP-1700-01

Blunt HP-1700-02

FREER  
HP-1702-15  
15 cm/6"

JOSEPH  
16 cm/6¼"

FOMON  
HP-1706-16  
16 cm/6¼"

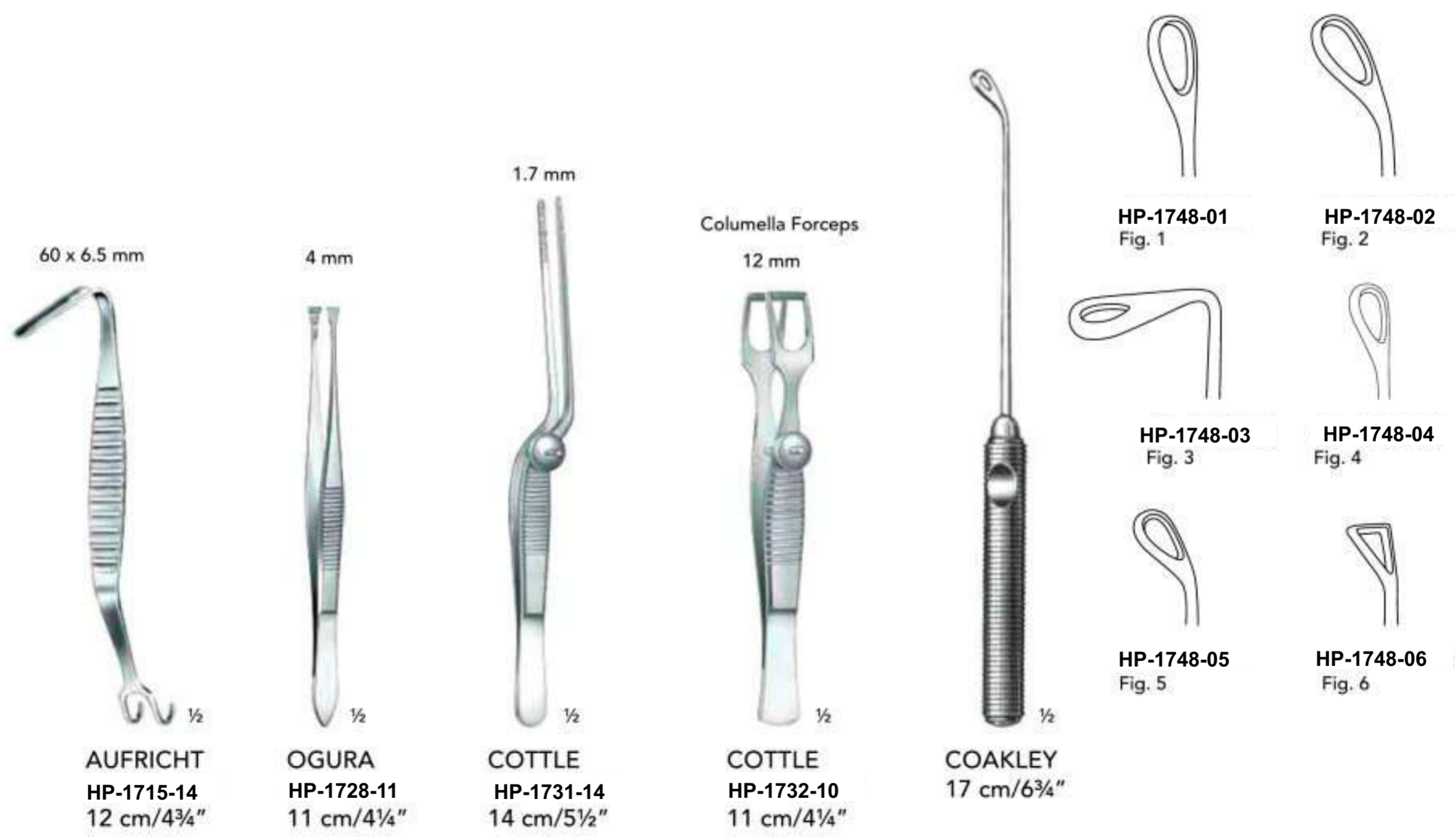
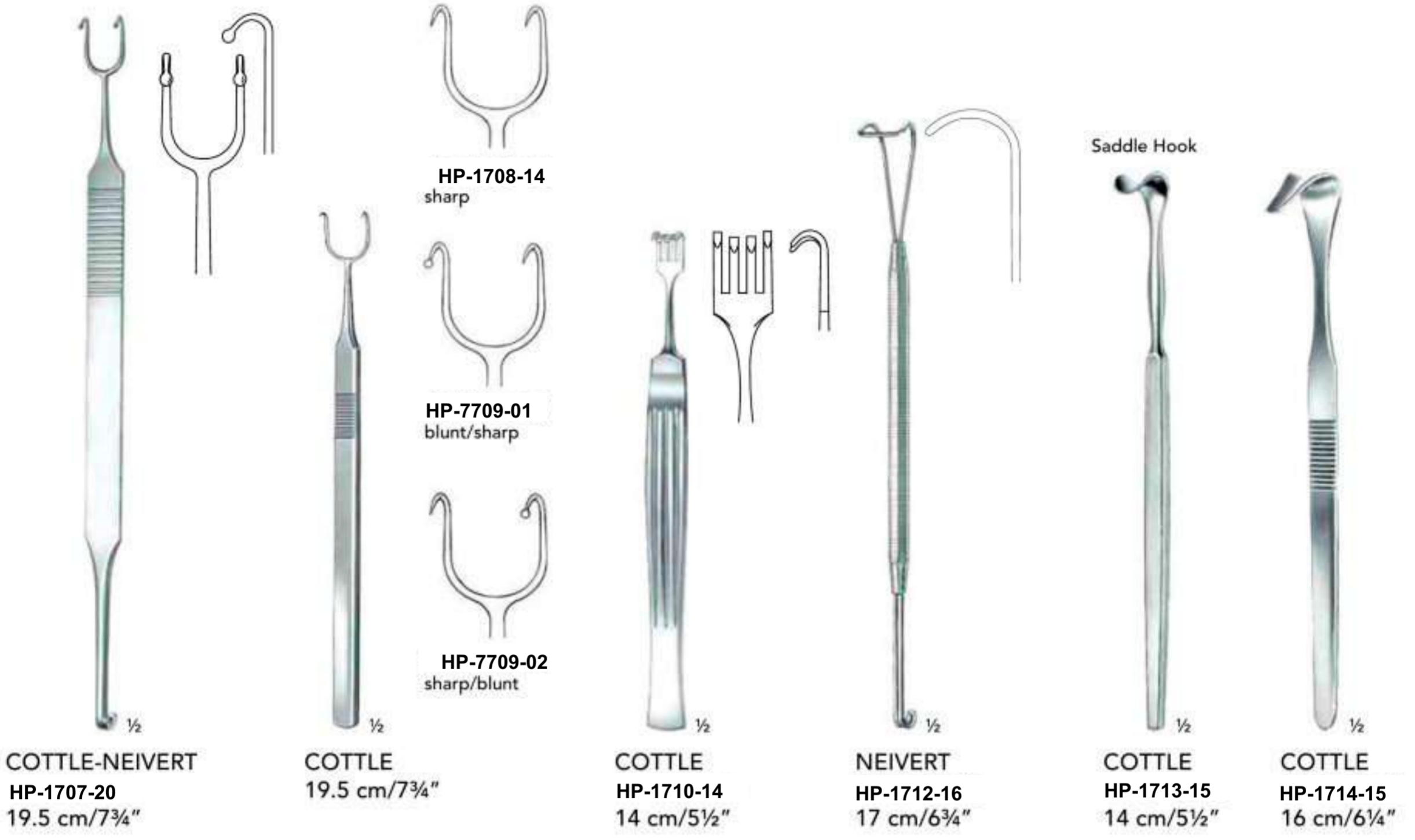



**GORNEY**  
19 cm/7½"

3 mm HP-1570-03  
4 mm HP-1570-04



**GUILLEN**  
HP-1840-20  
19 cm/7½"

HP-1840-90  
Obturator



**RITTER-HALLE**  
19 cm/7½"

41-1842-30  
Ø 3 mm

41-1842-40  
Ø 4 mm



**FAULKNER**  
HP-1842-21  
21 cm/8¼"



Fig.

1	13 mm	KI-1755-01
2	15 mm	KI-1755-02
3	17 mm	KI-1755-03
4	19 mm	KI-1755-04
5	21 mm	KI-1755-05
6	23 mm	KI-1755-06

**BECKMANN**  
22 cm/8¾"

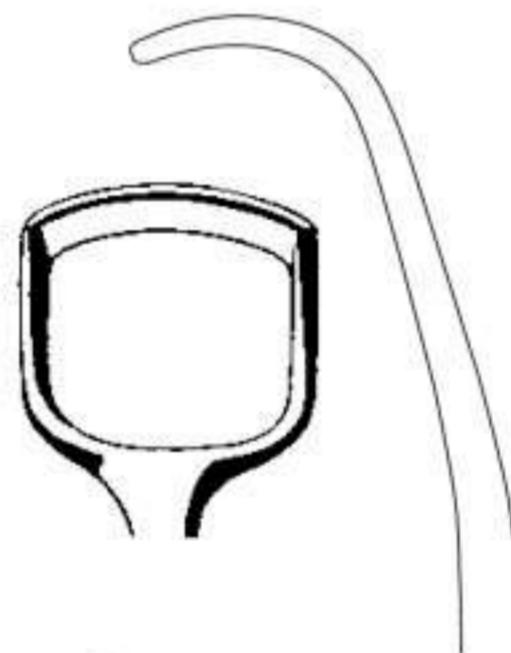

Fig.

1	13 mm	KI-1756-01
2	15 mm	KI-1756-02
3	17 mm	KI-1756-03
4	19 mm	KI-7756-04
5	21 mm	KI-1756-05
6	23 mm	KI-1756-06

**BECKMANN**  
21.5 cm/8½"



**KRESSNER**  
HP-1721-20  
22 cm/8¾"



**COTTLE-WALSHAM**  
16 cm/6¼"



**HP-1724-01**  
Straight



**HP-1724-02**  
Left



**HP-1724-03**  
Right



**ASCH**  
HP-1725-23  
22.5 cm/9"

## Sinus Surgery

- Antrum Cannula
- Antrum Curettes
- Antrum Punches
- Nasal Cutting Forceps
- Nasal Dressing Forceps
- Nasal Scissors
- Punches
- Sickle Knives
- Sinus Probes
- Sinus Seekers
- Spoon Forceps

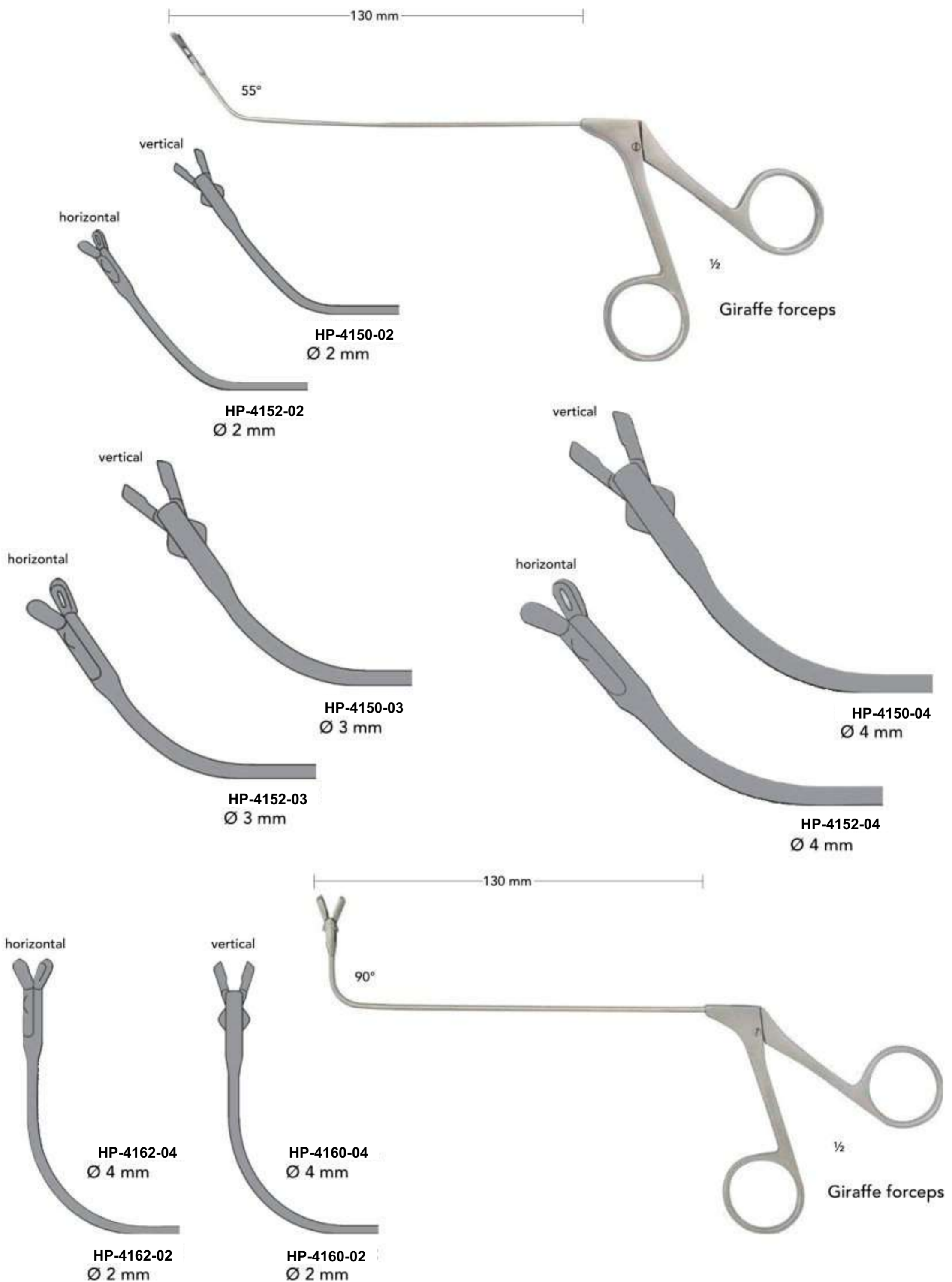

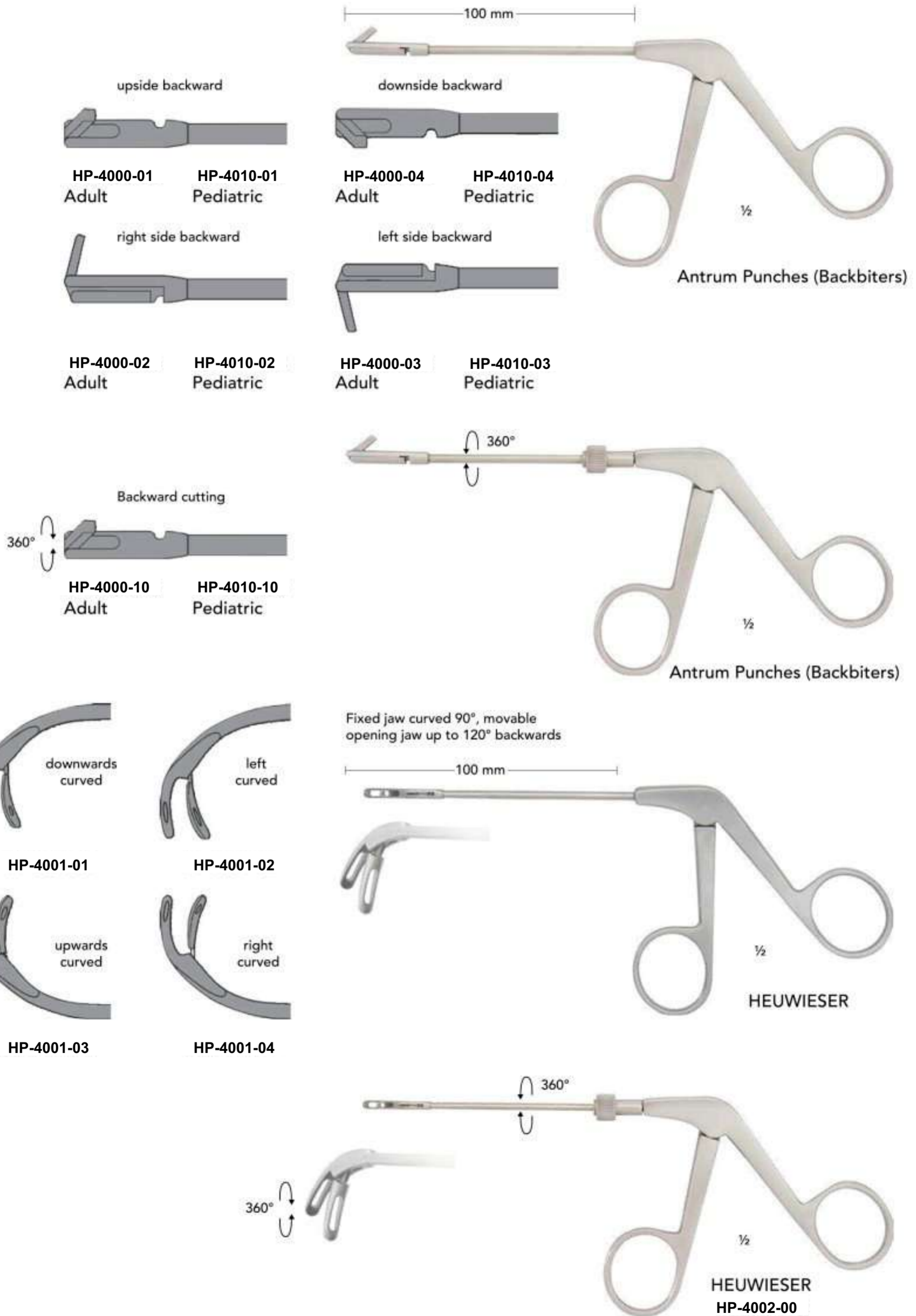



# Double Spoon Biopsy Forceps - Oval Shape

## Sinus Surgery

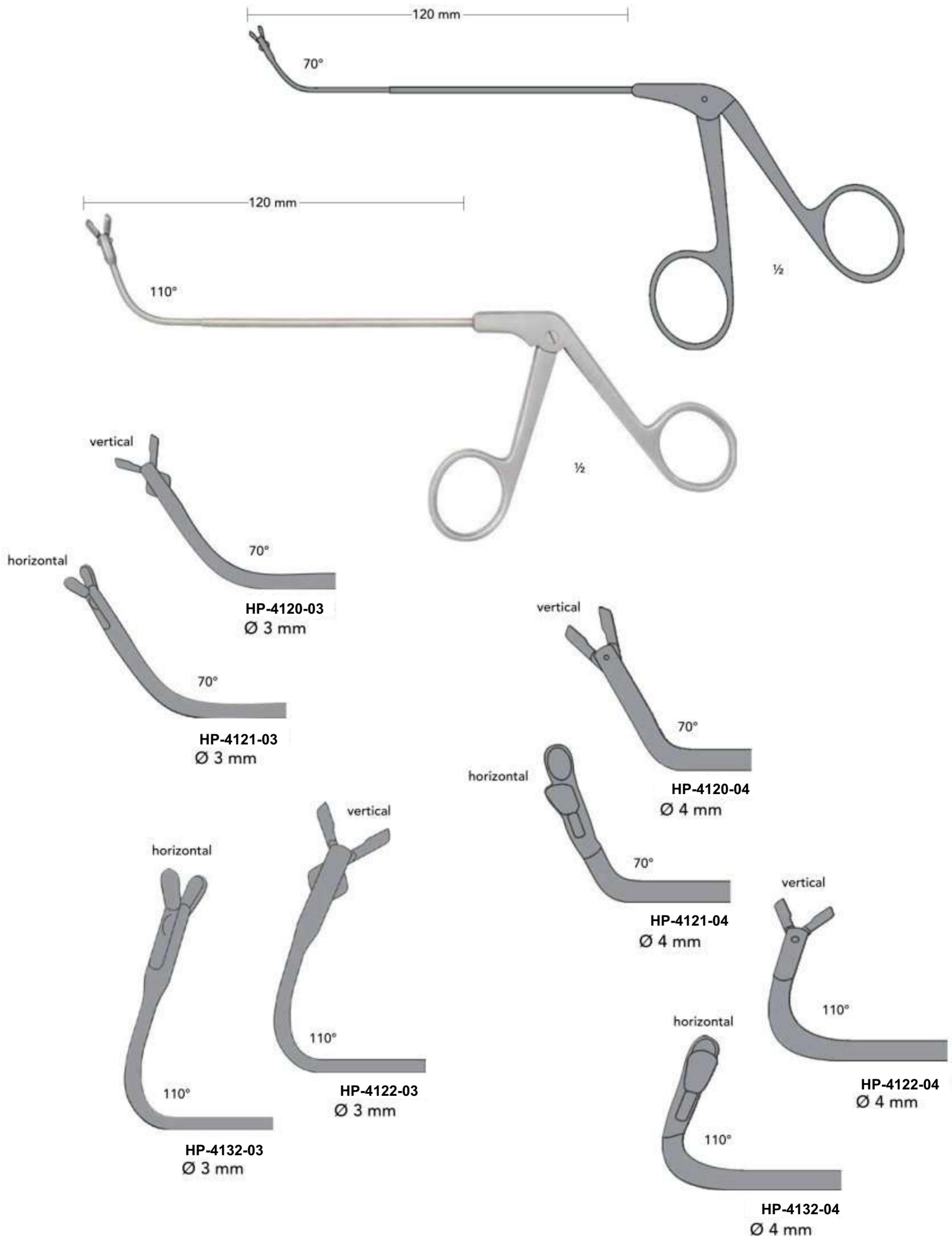

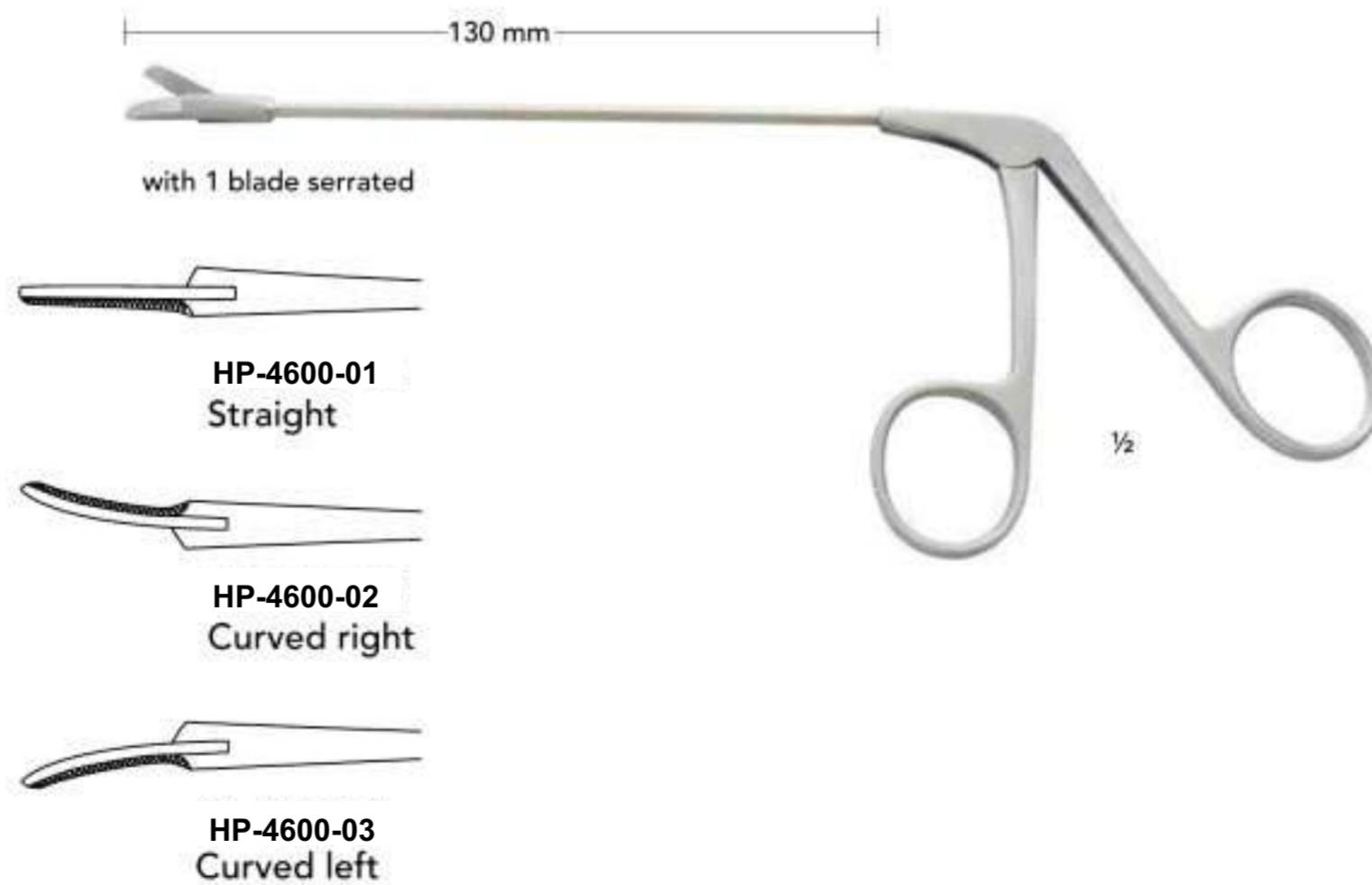
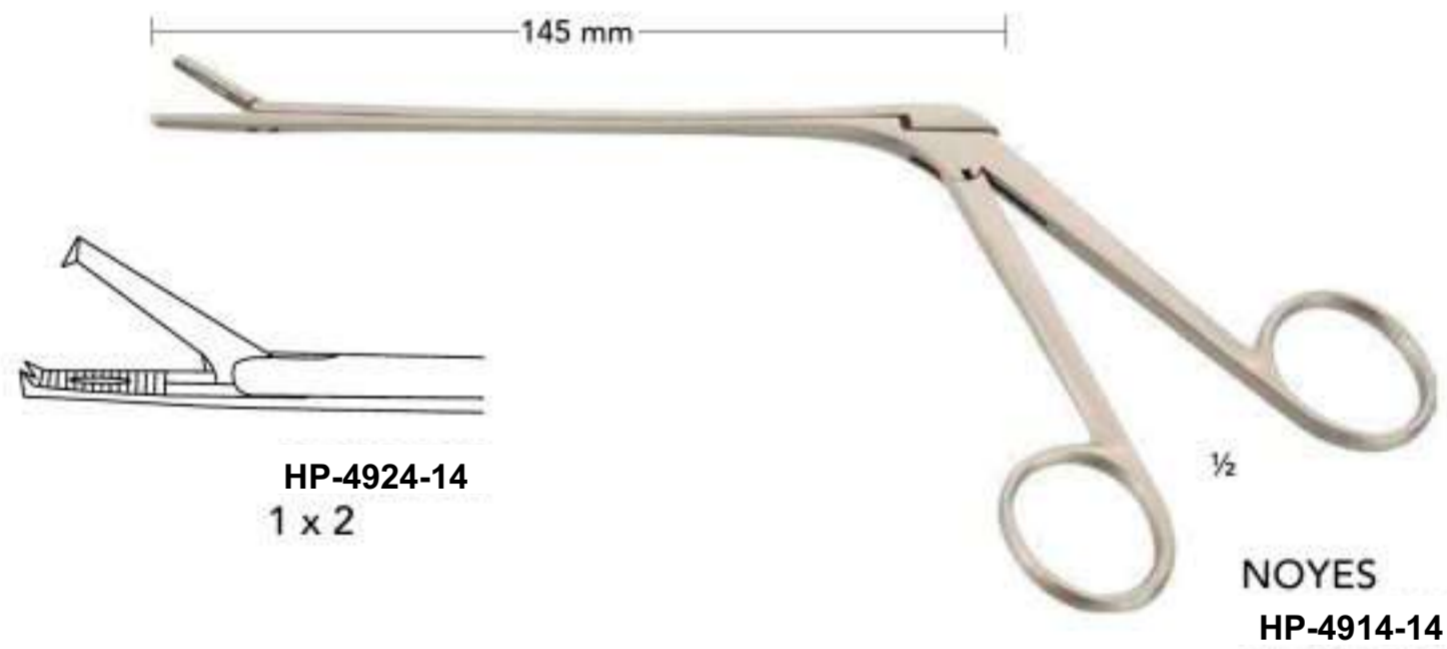
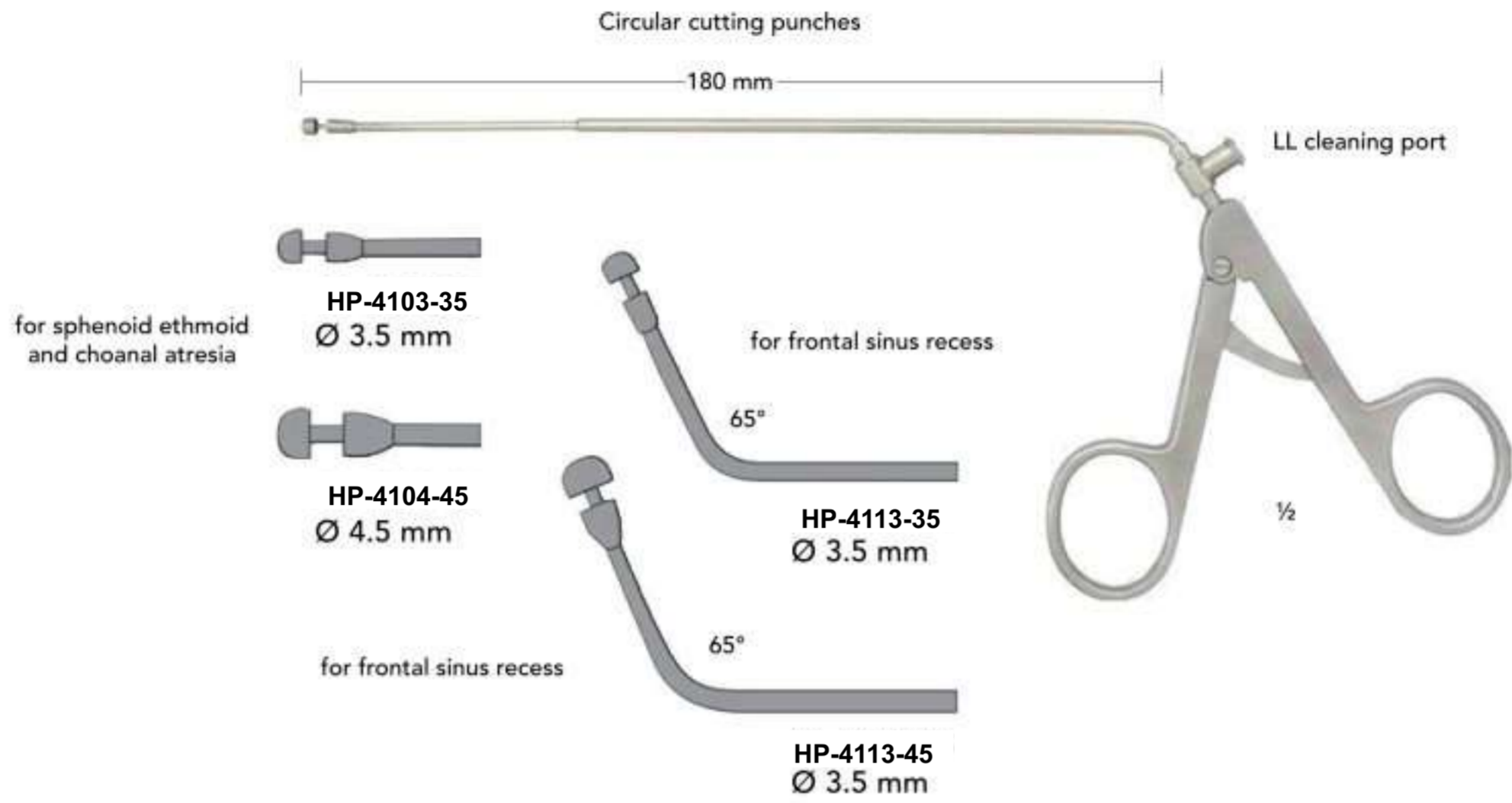

Sinus Surgery

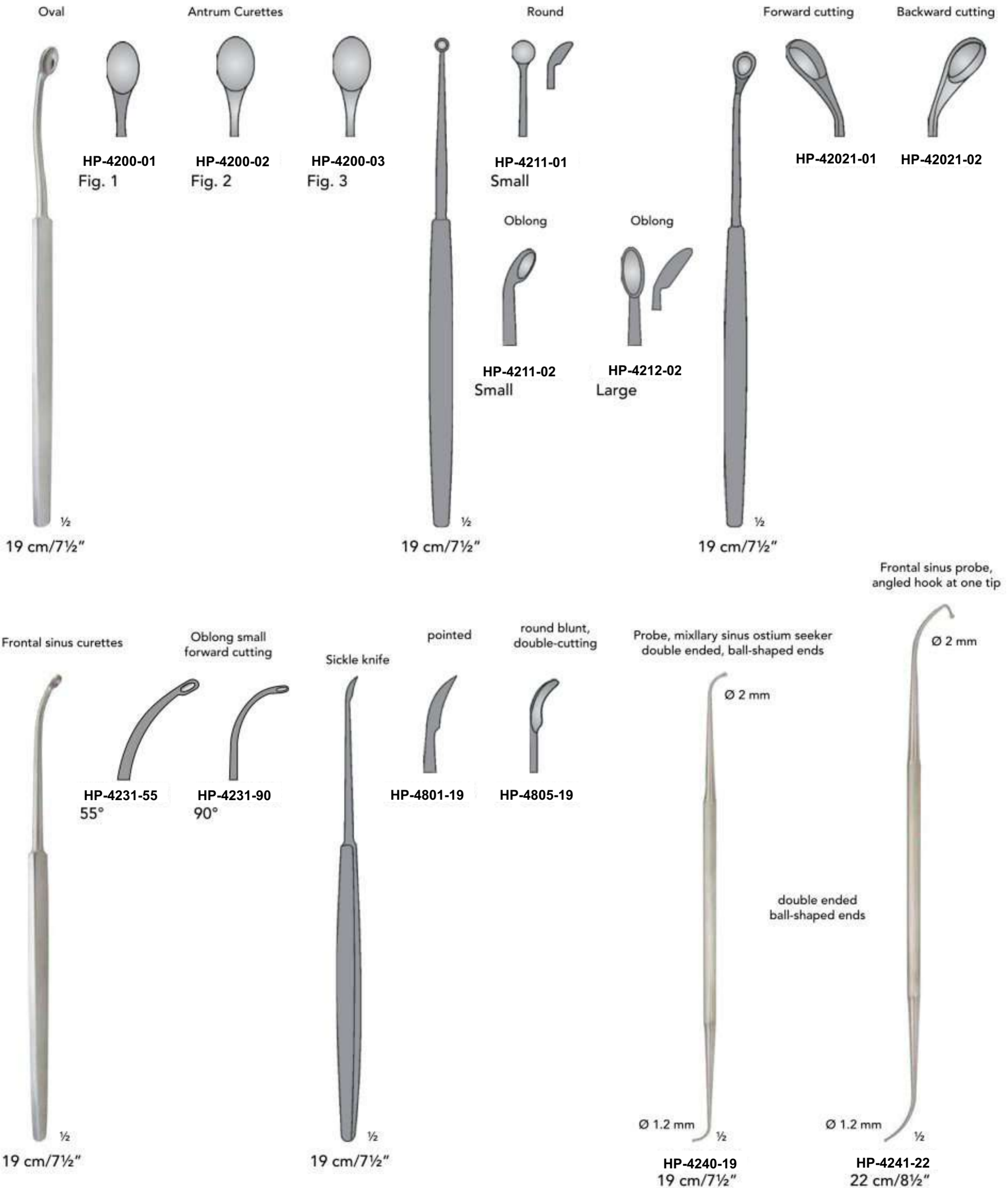

## Larynx, Tonsil

- Injection Needles
- Laryngeal Forceps
- Laryngeal Mirrors
- Laryngeal Polypus Forceps
- Retractors
- Tampon Forceps
- Tongue Depressor
- Tonsil Hemostatic Forceps
- Tonsil Knives
- Tonsil Punches
- Tonsil Seizing Forceps
- Tracheal Instruments

Larynx, Tonsil



Tonsil grasping forceps

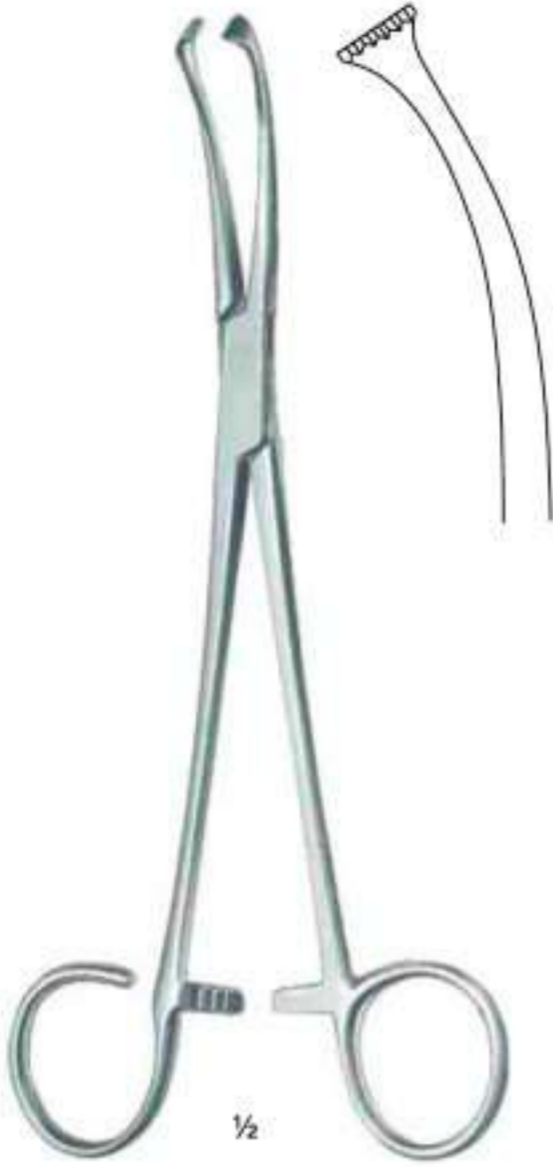

**WHITE**  
HP-4419-18  
18 cm/7"



**BLOHMKE**  
HP-4423-20  
20 cm/8"

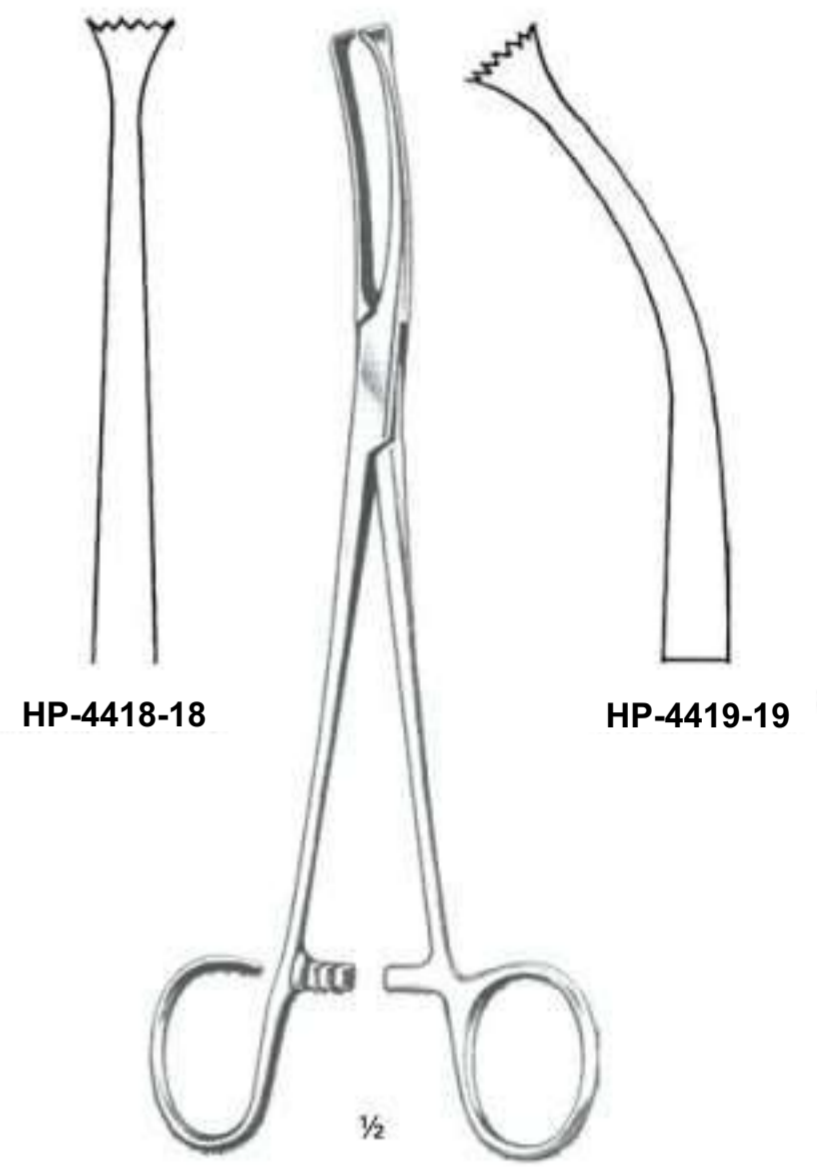

HP-4418-18

HP-4419-19

**COLVER**  
19 cm/7½"

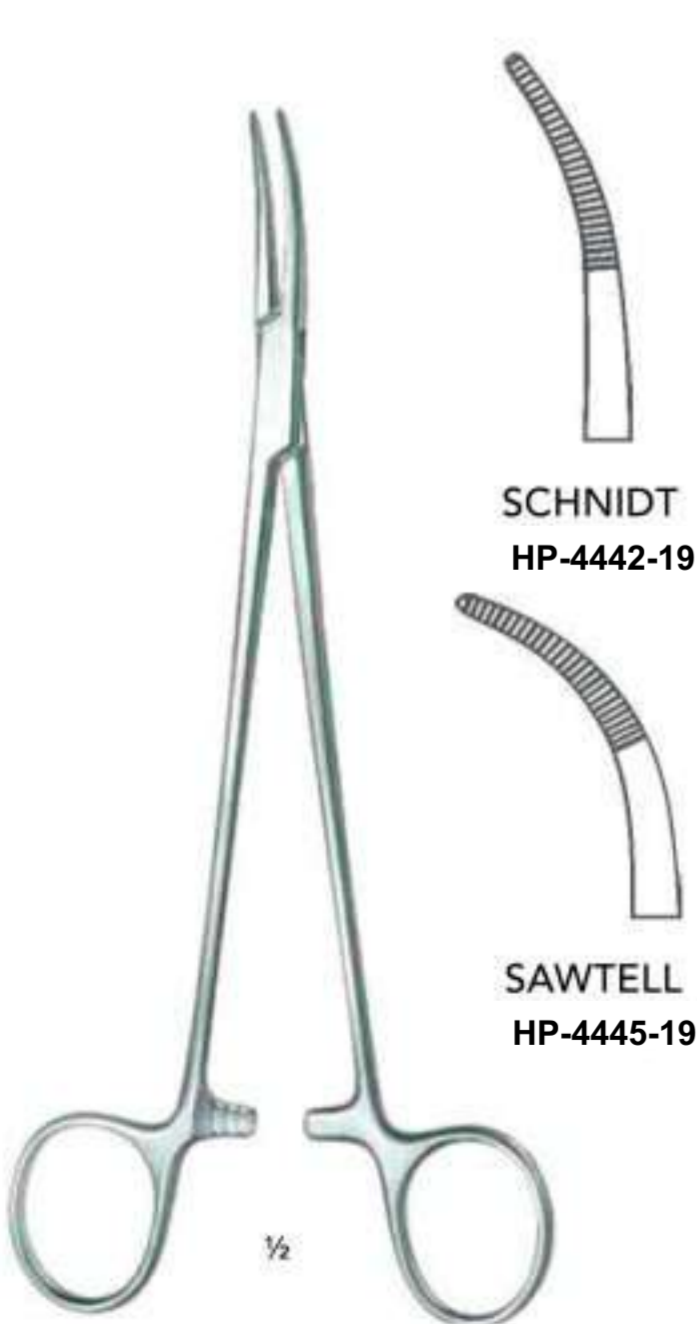

**SCHNIDT**  
HP-4442-19

**SAWTELL**  
HP-4445-19

19 cm/7½"

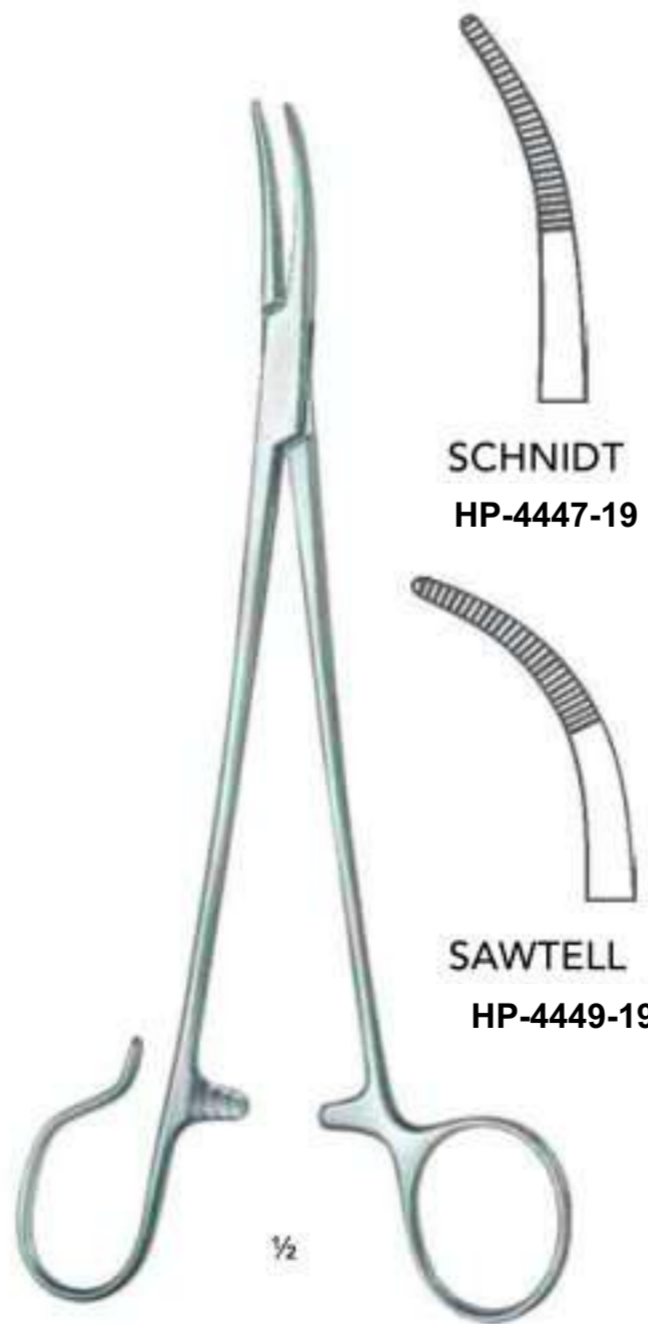

**SCHNIDT**  
HP-4447-19

**SAWTELL**  
HP-4449-19

19 cm/7½"



2 x 2  
HP-4422-22  
Fig. 1

3 x 3  
HP-4423-33  
Fig. 2

**TIVNEN-TYDINGS**  
21 cm/8¼"

# Tonsil Punch, Tonsil Snare

Larynx, Tonsil

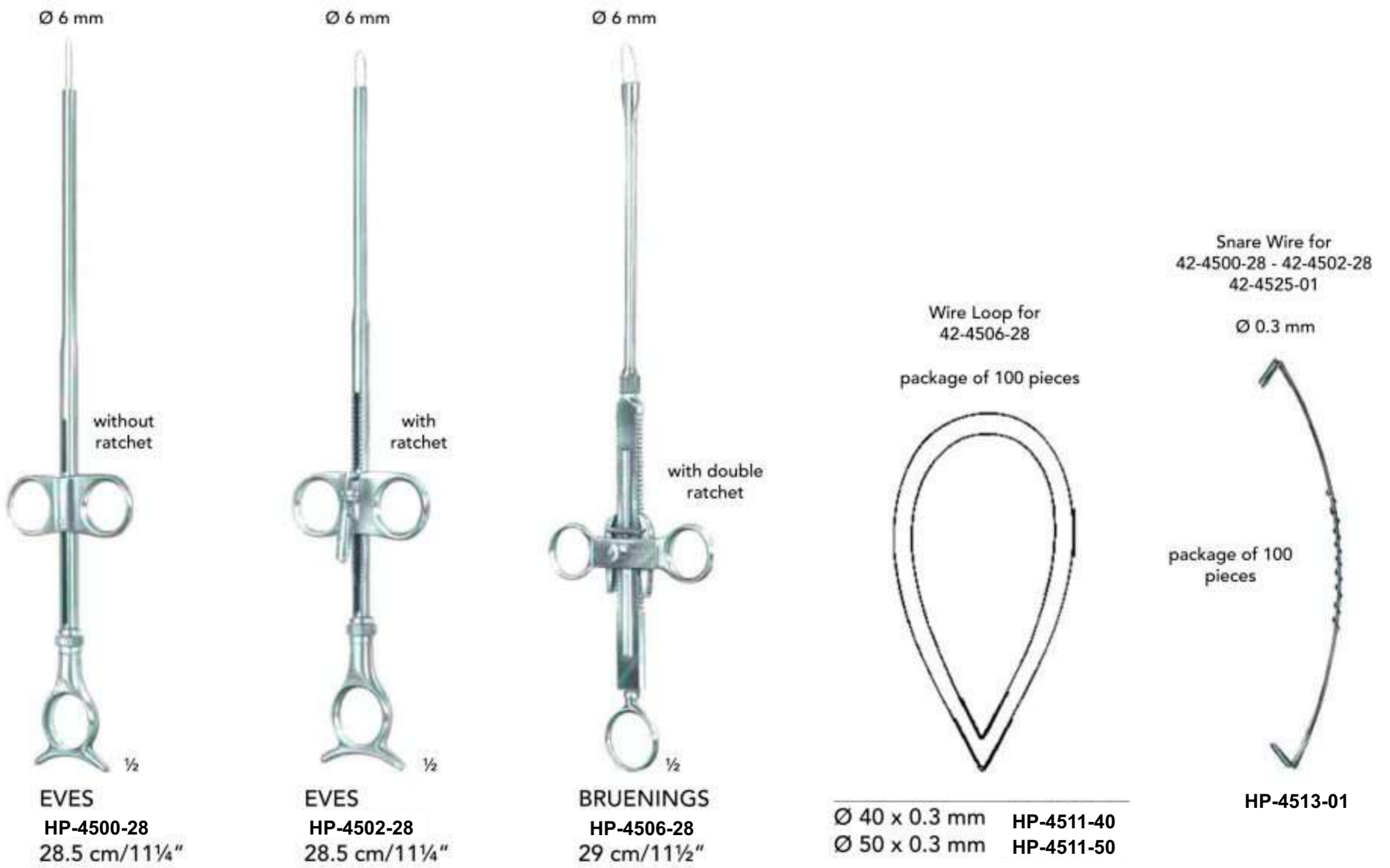
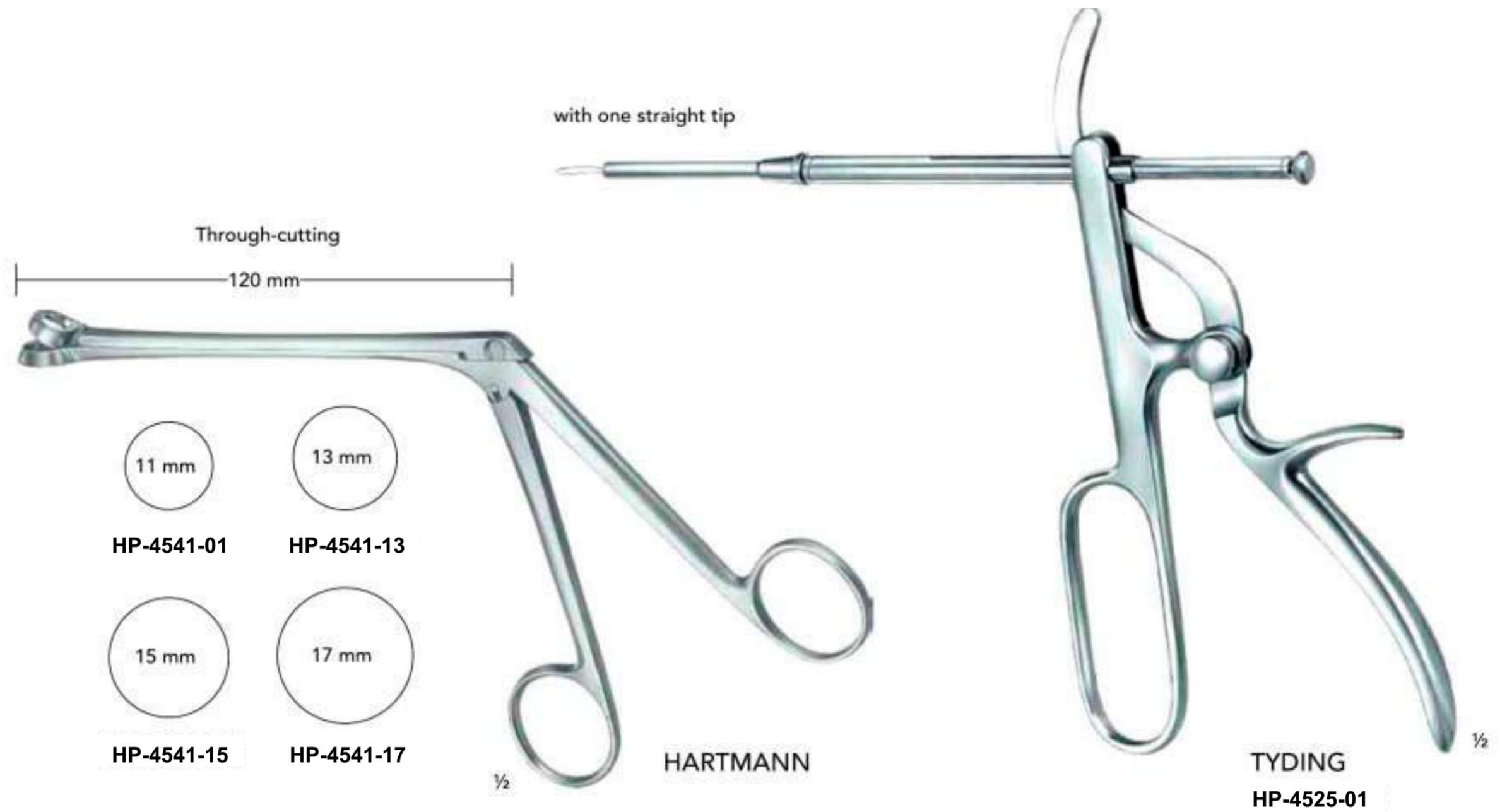



**BRUENINGS**  
 22 cm/8<sup>3</sup>/<sub>4</sub>" HP-584-20  
 32 cm/12<sup>3</sup>/<sub>4</sub>" HP-584-30  
 41 cm/16<sup>1</sup>/<sub>4</sub>" HP-584-40



**BRUENINGS**  
 HP-9587-20  
 18 cm/7"



**HUBER**  
 HP-9581-01



**FRAENKEL**  
 HP-9600-01



**SEIFFERT**  
 HP-9604-01



**FRAENKEL**  
 HP-9608-01



**SCHEINMANN**  
 HP-9611-01



**SCHEINMANN**  
 HP-9613-01



**BRUENINGS**  
 Fig. 2 HP-9616-02  
 Fig. 3 HP-9616-03



**BRUENINGS**  
 Fig. 2 HP-9618-02  
 Fig. 3 HP-9618-03



**LANGE**  
 HP-9624-01

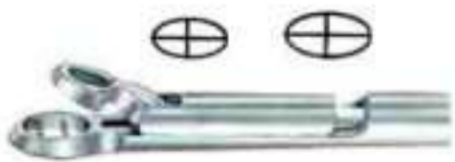

**KRAUSE**  
 Fig. 1 HP-9628-01  
 Fig. 2 HP-9628-02



**KRAUSE**  
 HP-9632-01

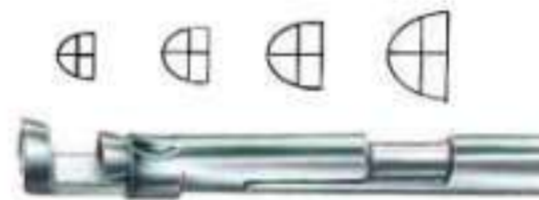

**CORDES**  
 Fig. 1 HP-9637-01  
 Fig. 2 HP-9637-02  
 Fig. 3 HP-9637-03  
 Fig. 4 HP-9637-04



**SCHUMACHER**  
 HP-9639-01



**CORDES**  
 Fig. 1 HP-9643-01  
 Fig. 2 HP-9643-02



**CORDES**  
 HP-9647-01



**ROSENBERG**  
 HP-9657-01



Plane, with fixed handle



18.5 cm/7¼"

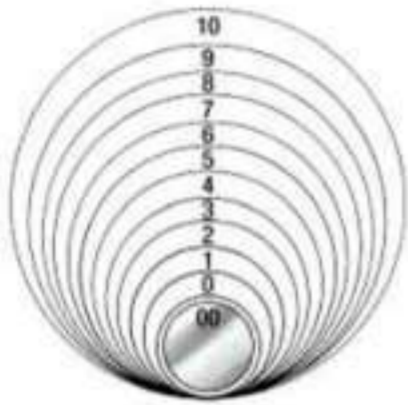
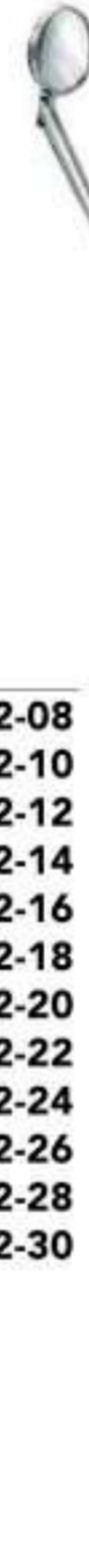
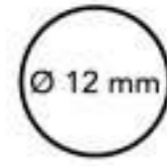

Fig. 00	Ø 8 mm	VI-4781-08
Fig. 0	Ø 10 mm	VI-4781-10
Fig. 1	Ø 12 mm	VI-4781-12
Fig. 2	Ø 14 mm	VI-4781-14
Fig. 3	Ø 16 mm	VI-4781-16
Fig. 4	Ø 18 mm	VI-4781-18
Fig. 5	Ø 20 mm	VI-4781-20
Fig. 6	Ø 22 mm	VI-4781-22
Fig. 7	Ø 24 mm	VI-4781-24
Fig. 8	Ø 26 mm	VI-4781-26
Fig. 9	Ø 28 mm	VI-4781-28
Fig. 10	Ø 30 mm	VI-4781-30

Moveable mirror



MICHEL  
27 cm/7½"



HP-4789-12  
Fig. 1



HP-4789-14  
Fig. 2

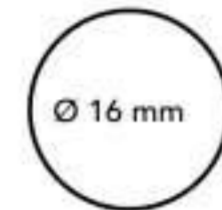

HP-4789-16  
Fig. 3

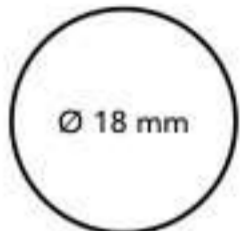

HP-4789-18  
Fig. 4

Rhodium front coated

Fig. 00	Ø 8 mm	VI-4782-08
Fig. 0	Ø 10 mm	VI-4782-10
Fig. 1	Ø 12 mm	VI-4782-12
Fig. 2	Ø 14 mm	VI-4782-14
Fig. 3	Ø 16 mm	VI-4782-16
Fig. 4	Ø 18 mm	VI-4782-18
Fig. 5	Ø 20 mm	VI-4782-20
Fig. 6	Ø 22 mm	VI-4782-22
Fig. 7	Ø 24 mm	VI-4782-24
Fig. 8	Ø 26 mm	VI-4782-26
Fig. 9	Ø 28 mm	VI-4782-28
Fig. 10	Ø 30 mm	VI-4782-30

Plane, without handle



13.5 cm/5¼"



Fig. 00	Ø 8 mm	VI-4785-08
Fig. 0	Ø 10 mm	VI-4785-10
Fig. 1	Ø 12 mm	VI-4785-12
Fig. 2	Ø 14 mm	VI-4785-14
Fig. 3	Ø 16 mm	VI-4785-16
Fig. 4	Ø 18 mm	VI-4785-18
Fig. 5	Ø 20 mm	VI-4785-20
Fig. 6	Ø 22 mm	VI-4785-22
Fig. 7	Ø 24 mm	VI-4785-24
Fig. 8	Ø 26 mm	VI-4785-26
Fig. 9	Ø 28 mm	VI-4785-28
Fig. 10	Ø 30 mm	VI-4785-30

Rhodium front coated

Fig. 00	Ø 8 mm	VI-4786-08
Fig. 0	Ø 10 mm	VI-4786-10
Fig. 1	Ø 12 mm	VI-4786-12
Fig. 2	Ø 14 mm	VI-4786-14
Fig. 3	Ø 16 mm	VI-4786-16
Fig. 4	Ø 18 mm	VI-4786-18
Fig. 5	Ø 20 mm	VI-4786-20
Fig. 6	Ø 22 mm	VI-4786-22
Fig. 7	Ø 24 mm	VI-4786-24
Fig. 8	Ø 26 mm	VI-4786-26
Fig. 9	Ø 28 mm	VI-4786-28
Fig. 10	Ø 30 mm	VI-4786-30



HP-4794-11  
11 cm/4¼"



HP-4798-12  
12.5 cm/5"



**FRAENKEL**  
HP-4519-18  
18 cm/7"



**HP-4814-01**  
Fig. 1

**HP-4814-02**  
Fig. 2

**HP-4814-03**  
Fig. 3

**HP-4814-04**  
Fig. 4

**JURASZ**  
23 cm/9"

13.5 mm



**NAGER**  
HP-4624-19  
19 cm/17 1/2"

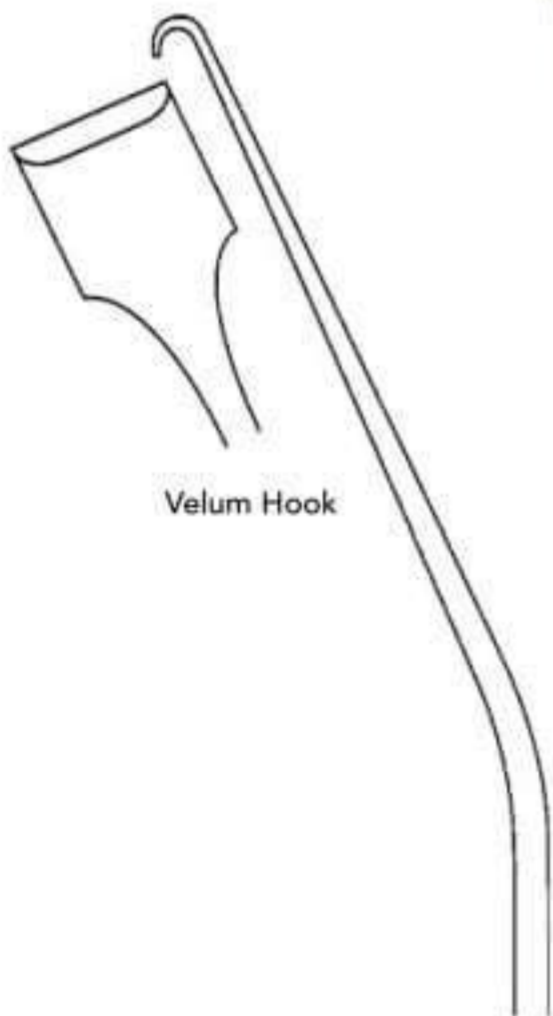

Velum Hook



Arch palate hook

**HOFER**  
HP-4644-24  
24 cm/9 1/2"



**REICHERT**  
HP-4624-24  
24 cm/9 1/2"

3 mm

3 mm



**JACKSON**  
HP-4022-22  
22 cm/8 3/4"

**HP-4122-22**

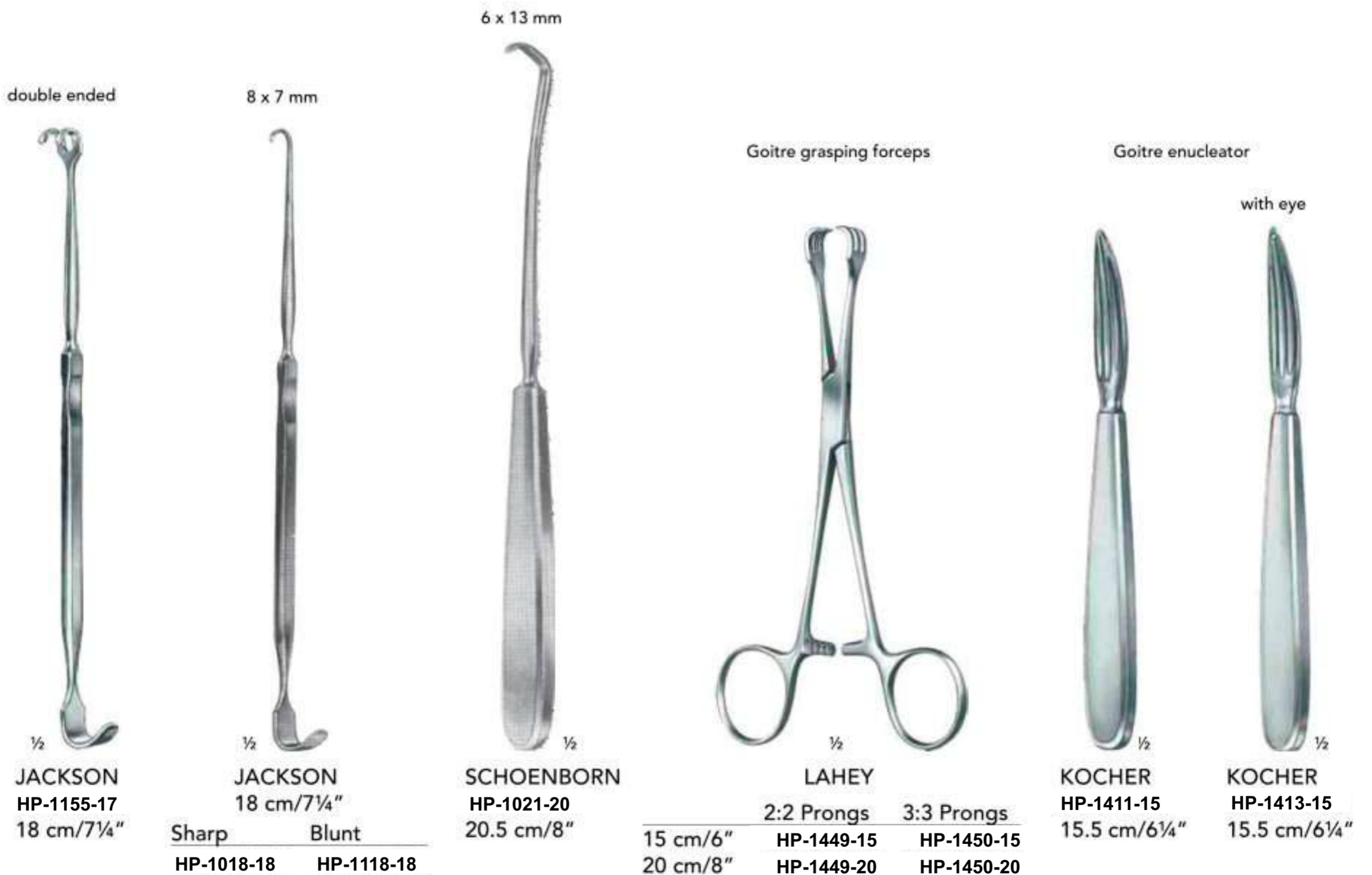
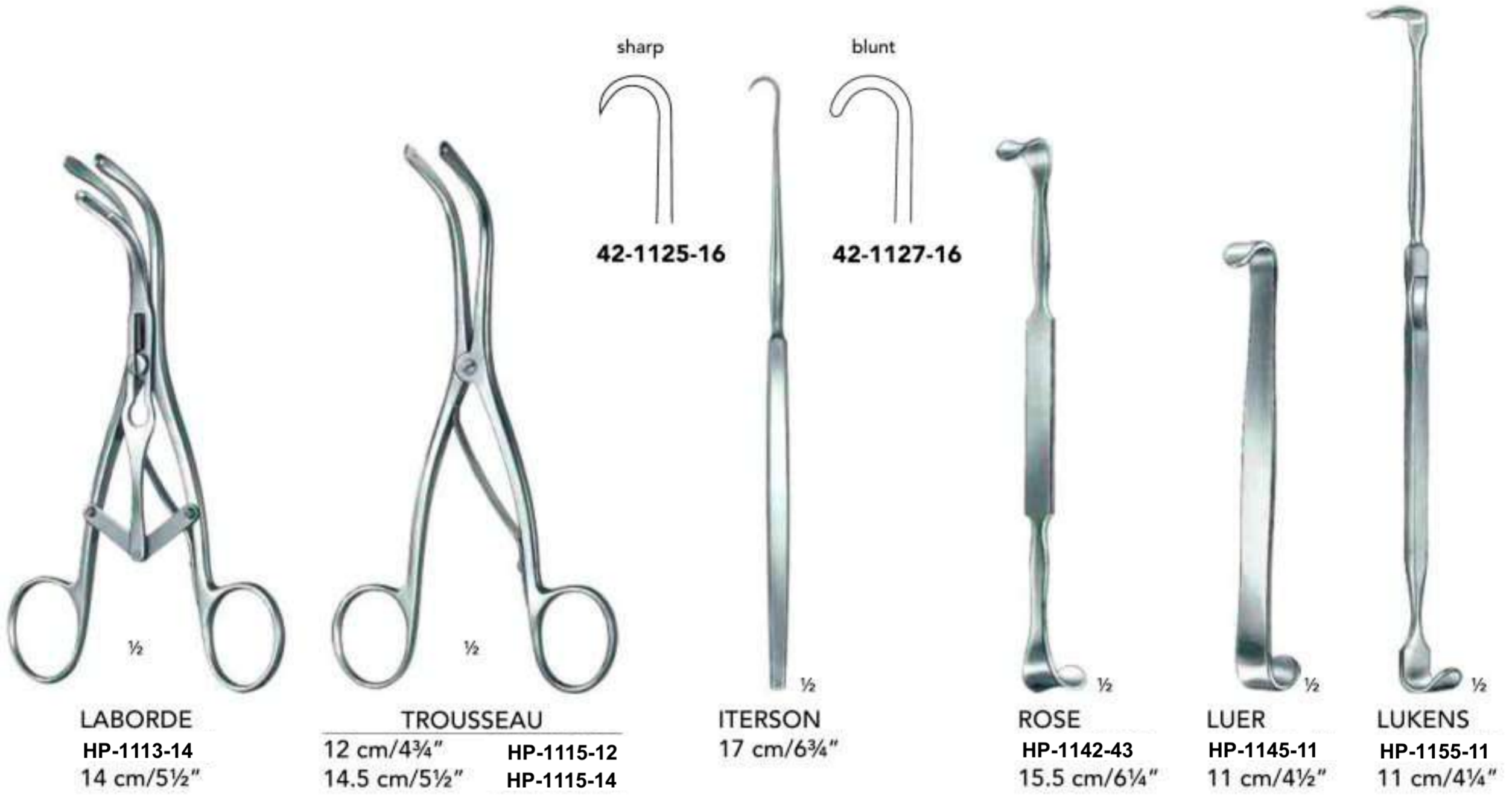



## Microlaryngology

- Chest Supports
- Cotton Carriers
- Injection Cannulas
- Light Guide Carriers
- Microlaryngology Forceps
- Microlaryngology Instruments
- Microlaryngology Needle Holders
- Microlaryngology Scissors
- Operating Laryngoscopes
- Suction Tubes
- Teeth Protectors

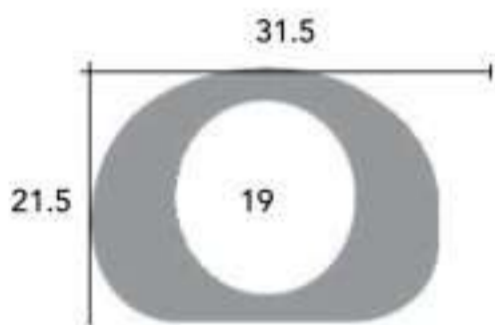
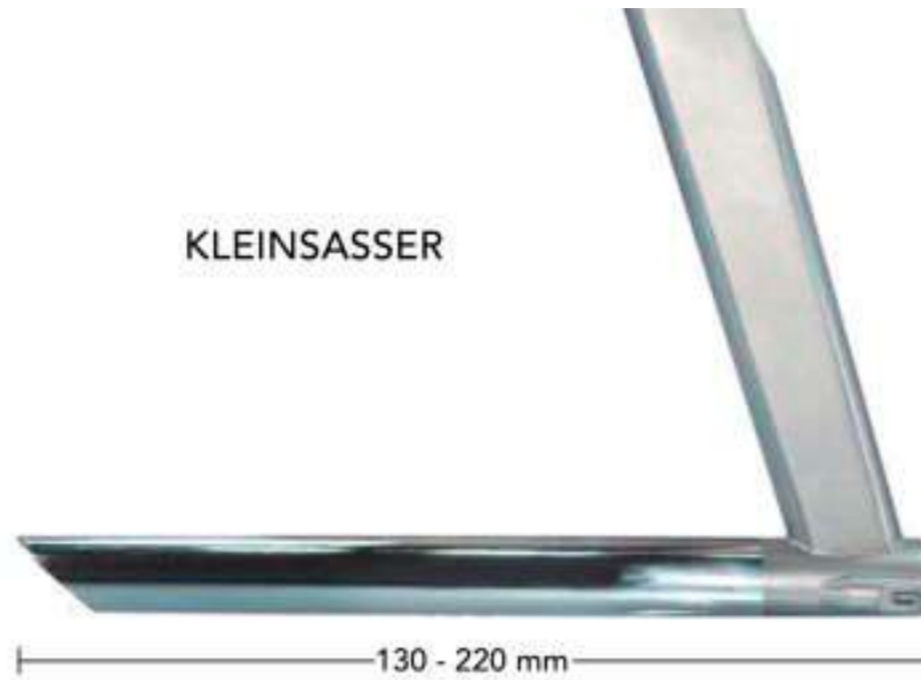

**HP-8201-17**  
17 cm/6¾"  
Adult X - Large

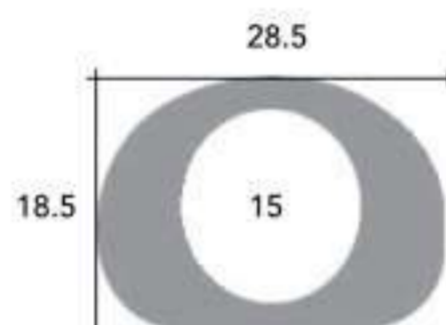

**HP-8202-17**  
17 cm/6¾"  
Adult Large

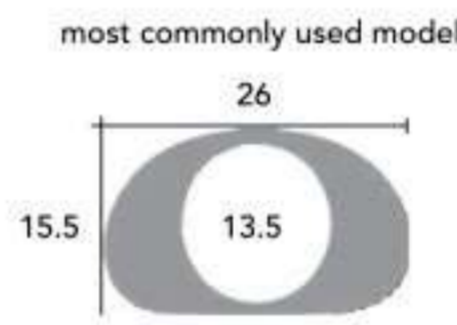

most commonly used model  
**HP-8203-17**  
17 cm/6¾"  
Adult Medium

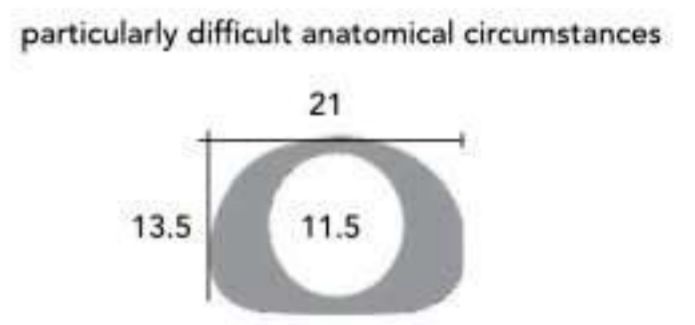

particularly difficult anatomical circumstances  
**HP-8204-17**  
18 cm/7"  
Adult Small

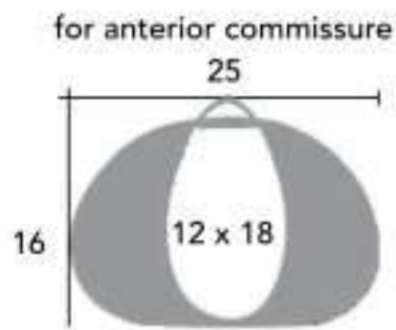

**HP-8205-18**  
18 cm/7"  
Adult Medium

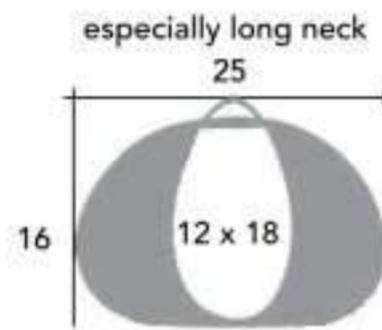

**HP-8206-22**  
22 cm/8¾"  
Adult Medium

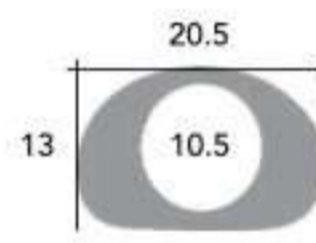

**HP-8207-15**  
15 cm/6"  
Children Small

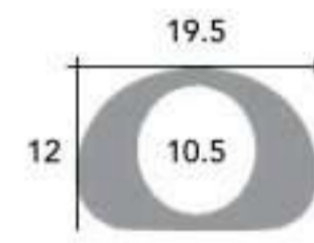

**HP-8208-13**  
13 cm/5"  
Infant Small



**HP-8222-14**



**HP-8232-12**



**HP-8241-08**



Spreadable

130 - 220 mm

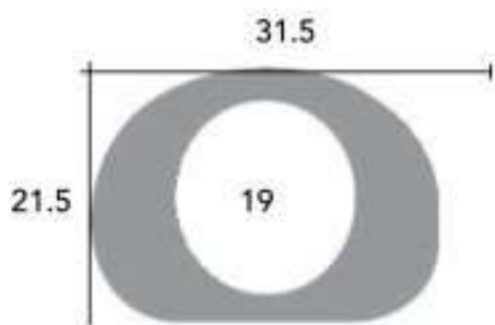

**HP-8211-17**  
17 cm/6¾"  
Adult X - Large

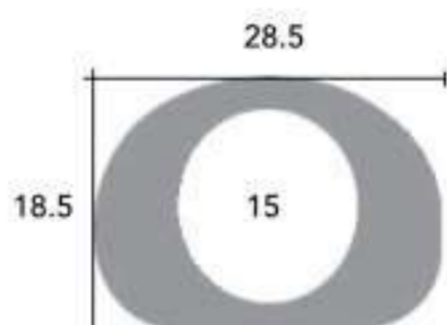

**HP-8212-17**  
17 cm/6¾"  
Adult Large

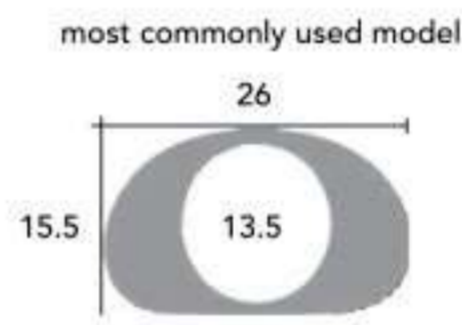

most commonly used model  
**HP-8213-17**  
17 cm/6¾"  
Adult Medium

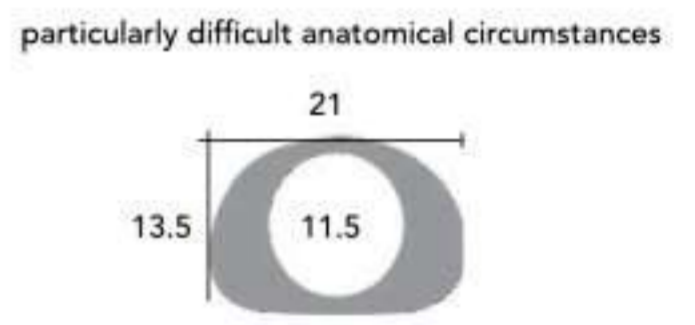

particularly difficult anatomical circumstances  
**HP-8214-18**  
18 cm/7"  
Adult Small

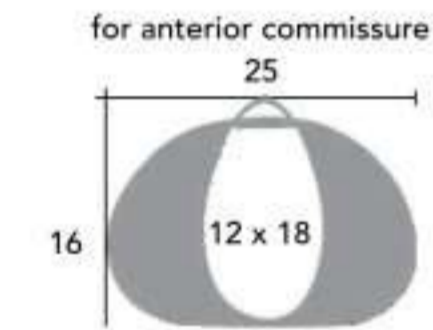

**HP-8215-18**  
18 cm/7"  
Adult Medium

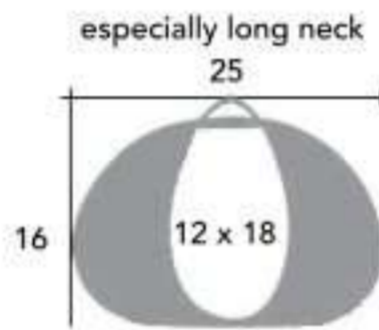

**HP-8216-22**  
22 cm/8¾"  
Adult Medium

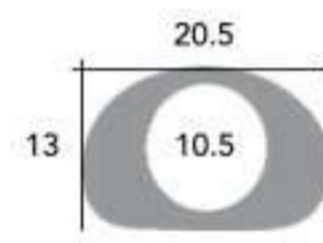

**HP-8217-15**  
15 cm/6"  
Children Small

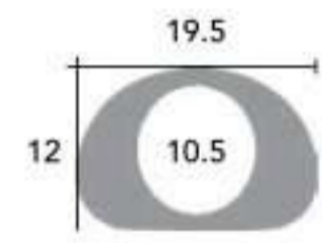

**HP-8218-13**  
13 cm/5"  
Infant Small



**HP-8222-14**



**HP-8232-12**



**HP-8241-08**

**KLEINSASSER Chest Support**

With adjustment wheel, Ring Diameter Ø 9.5 mm

	Working length	for
HP-8110-24	24 cm/9½"	Children
HP-8120-34	34 cm/13½"	Adults



with adjustment wheel

**Support Rod Only, With ring**

	Working length	for
HP-8115-24	24 cm/9½"	Children
HP-8125-24	34 cm/13½"	Adults



**Holder Only**

	for
HP-8115-99	Chest Support





**HOLINGER Operating Laryngoscope**  
Complete with light guide

	Use for	Handles	Working Length
HP-8551-12	Babies	Small	12.5 cm/5"
HP-8551-17	Children	Small	17 cm/6¾"
HP-8551-18	Adult	Large	18 cm/7"



**JACKSON Operating Laryngoscope**  
Complete with light guide

	Use for	Handles	Working Length
HP-8561-12	Babies	Small	12.5 cm/5"
HP-8561-17	Children	Small	17 cm/6¾"
HP-8561-18	Adult	Large	18 cm/7"





Microsurgery Forceps - Finger Movable

	Ø 2 mm	Grasping Forceps	
	HP-8621-02	Straight	
	HP-8622-02	Upwards	
	HP-8623-02	Curved right	
	HP-8624-02	Curved left	
	Ø 2 mm	Scissors	
	HP-8631-02	Straight	
	HP-8632-02	Upwards 45°	
	HP-8633-02	Curved right	
	HP-8634-02	Curved left	
	HP-8635-02	Curved horizontal	
Ø 4 mm	Ø 2 mm	Cup Shaped Forceps	
HP-8601-04	HP-8601-02	Straight	
HP-8602-04	HP-8602-02	Upwards	
HP-8603-04	HP-8603-02	Curved right	
HP-8604-04	HP-8604-02	Curved left	

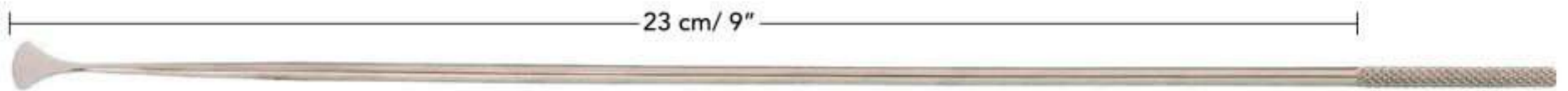

HP-8251-01	knife, oval, straight	
HP-8251-02	knife, oval, 45°	
HP-8251-03	sickel knife, curved	
HP-8251-04	sickel knife, straight	
HP-8251-05	knife, golf stick shaped	
HP-8251-06	knife, round, vertical cutting	
HP-8251-07	hook, blunt	
HP-8251-08	hook, sharp	
HP-8251-09	hook, with probe end 90°	
HP-8251-10	needle, curved to right	
HP-8251-11	needle, curved to left	
HP-8251-12	elevator, with suction channel	
HP-8251-13.	knot pusher / tier	

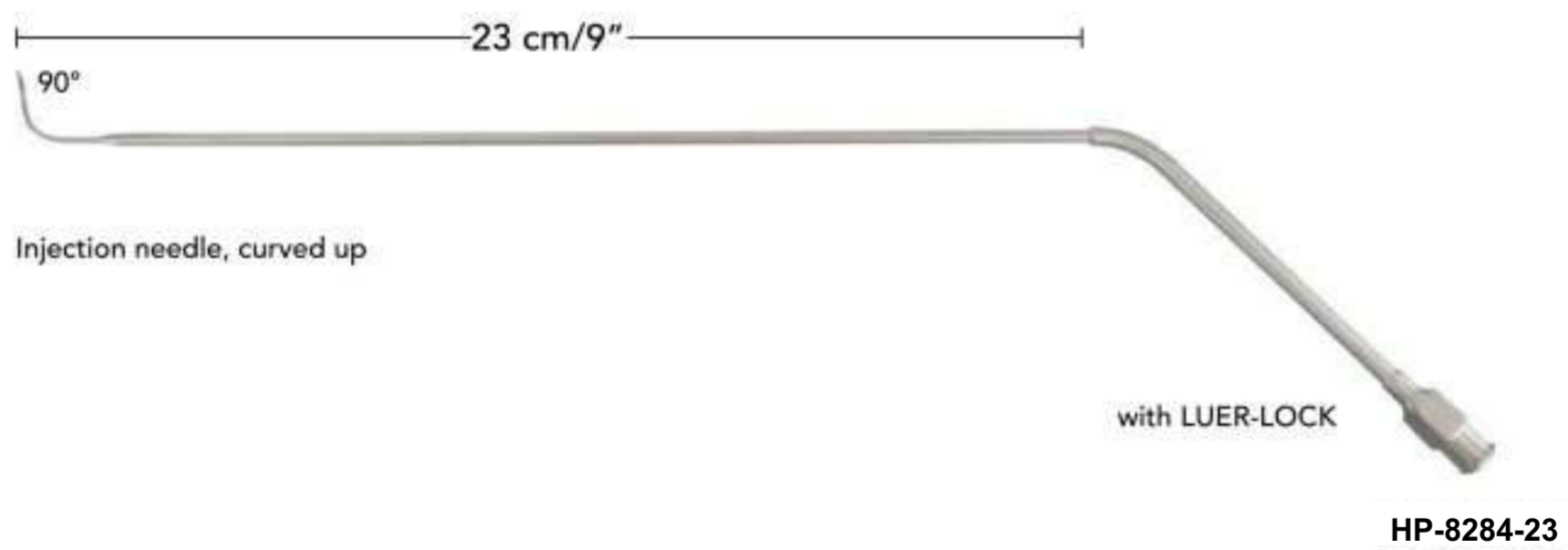
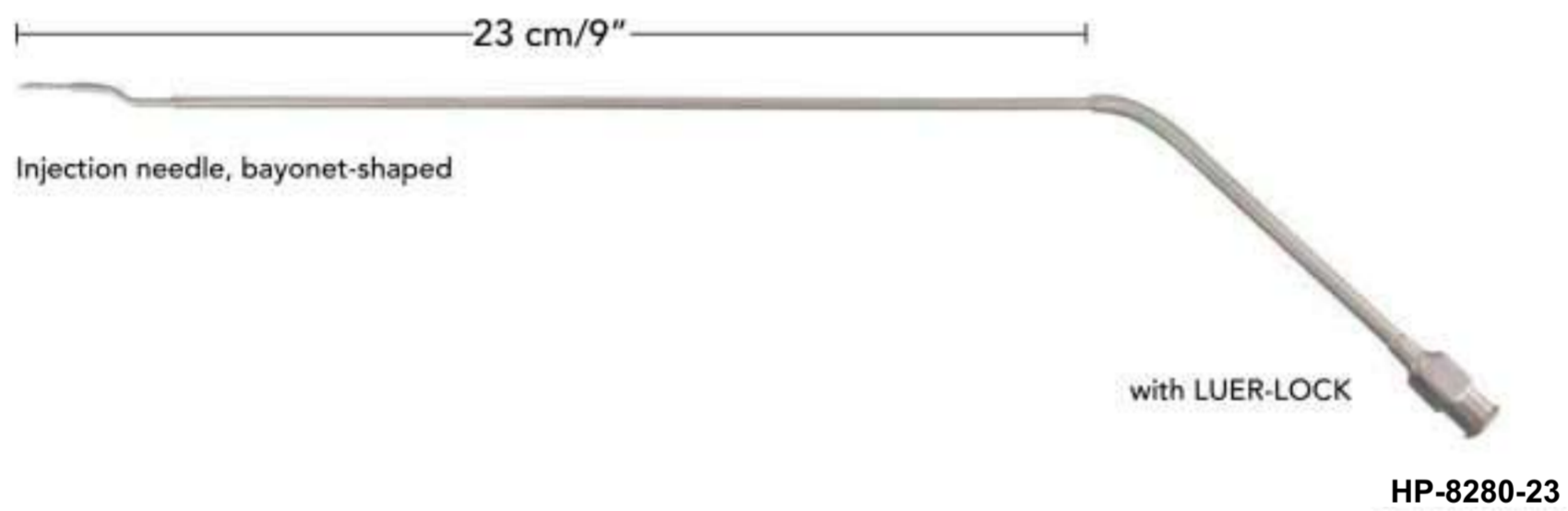
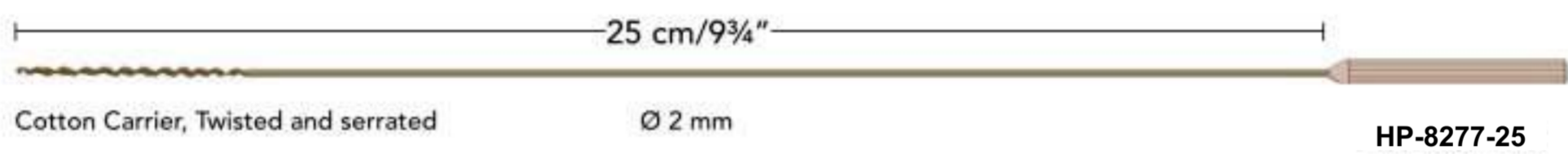
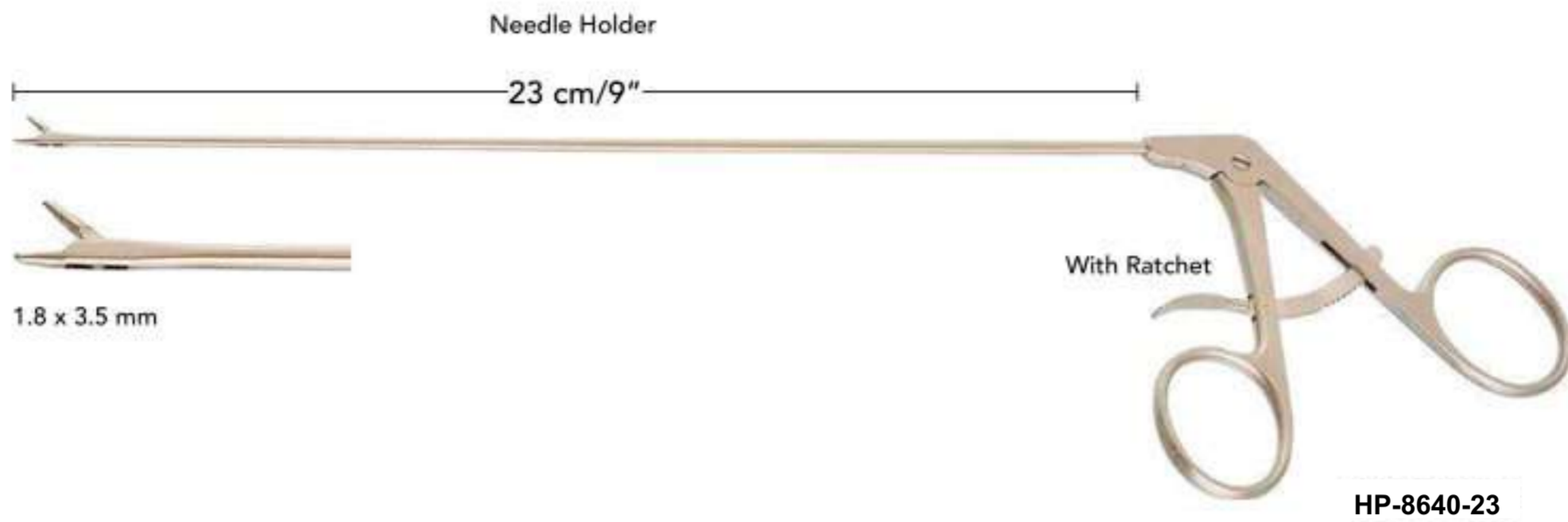

## Oral & Maxilo Facial

- Bone Contouring Forceps
- Cheek Retractor
- Chest Support
- Extra Oral Retractors
- Intra Oral Retractors
- Lip & Cheek Vestibulum Retractors
- Mandibular Retractors
- Mouthgags
- Multi Purpose Retractors
- Osteotomes
- Periosteal Elevators
- Ramus Retractors
- Soft Tissue Retractors



HP-4224-04  
Fram only



HP-4224-01  
Fig. 1

HP-4224-02  
Fig. 2

HP-4224-03  
Fig. 3

DINGMANN  
HP-4224-00  
Complete Set



HP-4222-01  
Fig. 1

HP-4222-02  
Fig. 2

HP-4222-03  
Fig. 3



McIVOR  
HP-4222-00  
Complete set

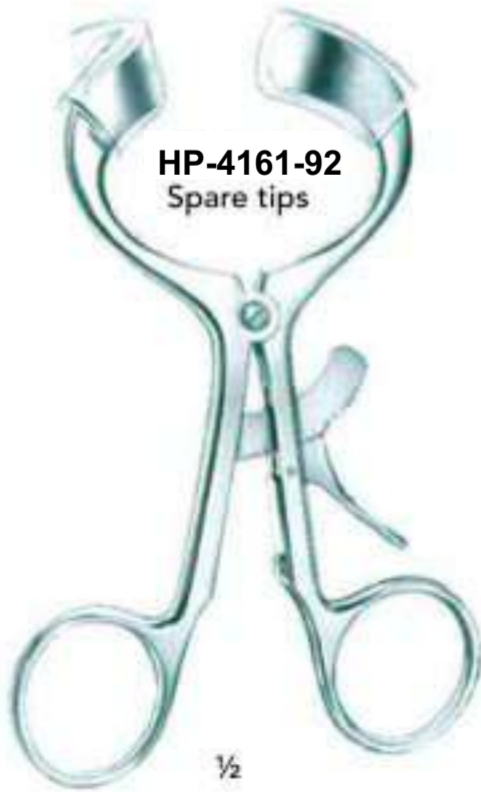
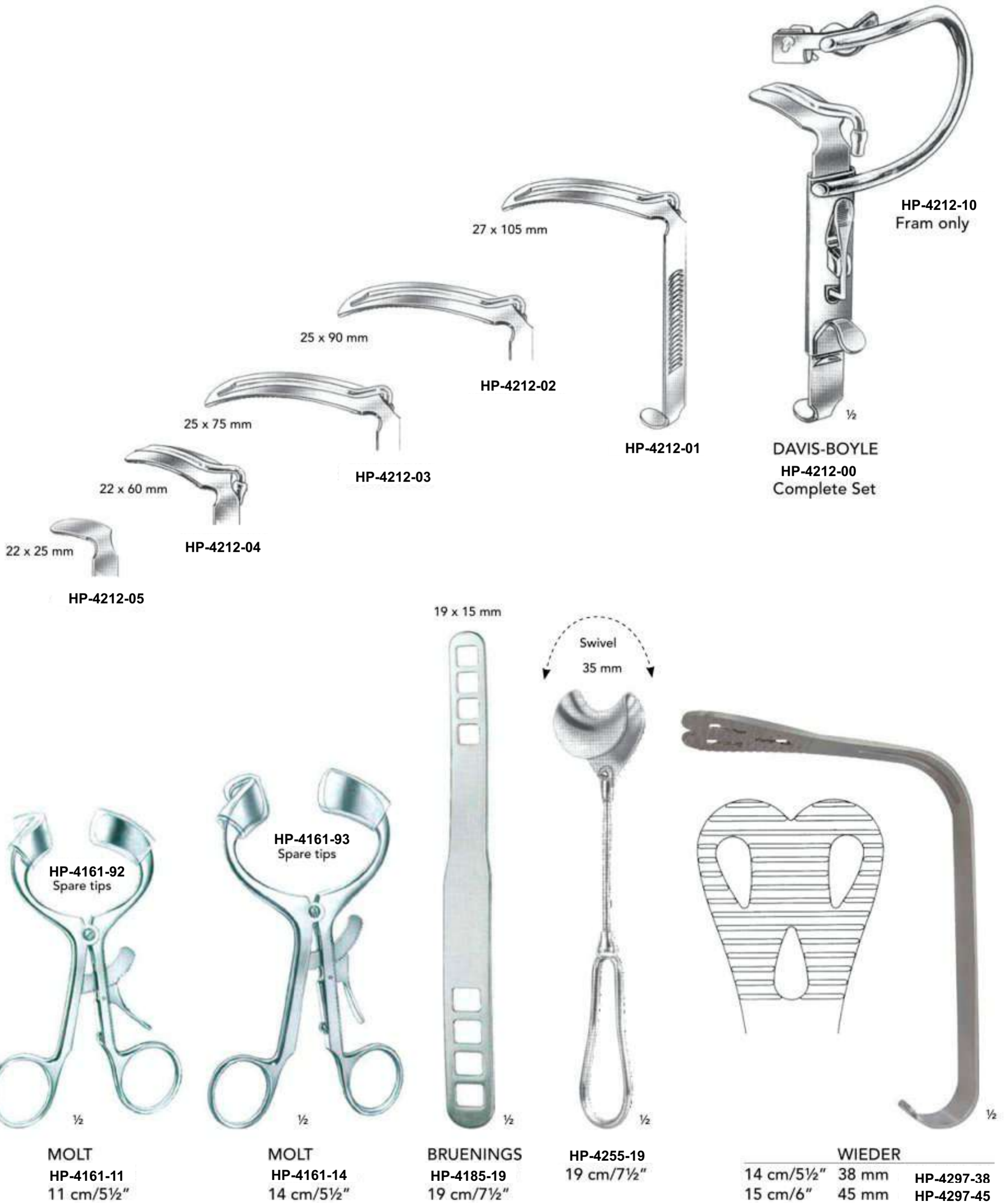

HP-4161-92  
Spare tips

MOLT  
HP-4161-11  
11 cm/5 1/2"

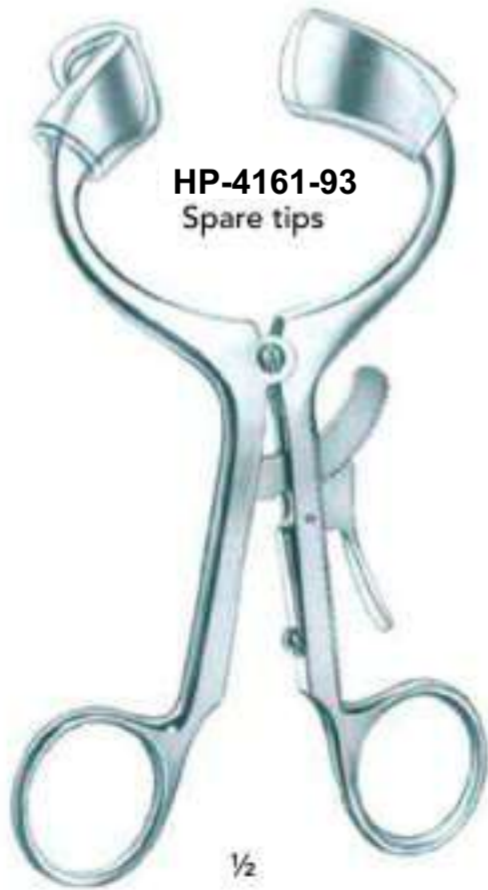

HP-4161-93  
Spare tips

MOLT  
HP-4161-14  
14 cm/5 1/2"



BRUENINGS  
HP-4185-19  
19 cm/7 1/2"



HP-4255-19  
19 cm/7 1/2"

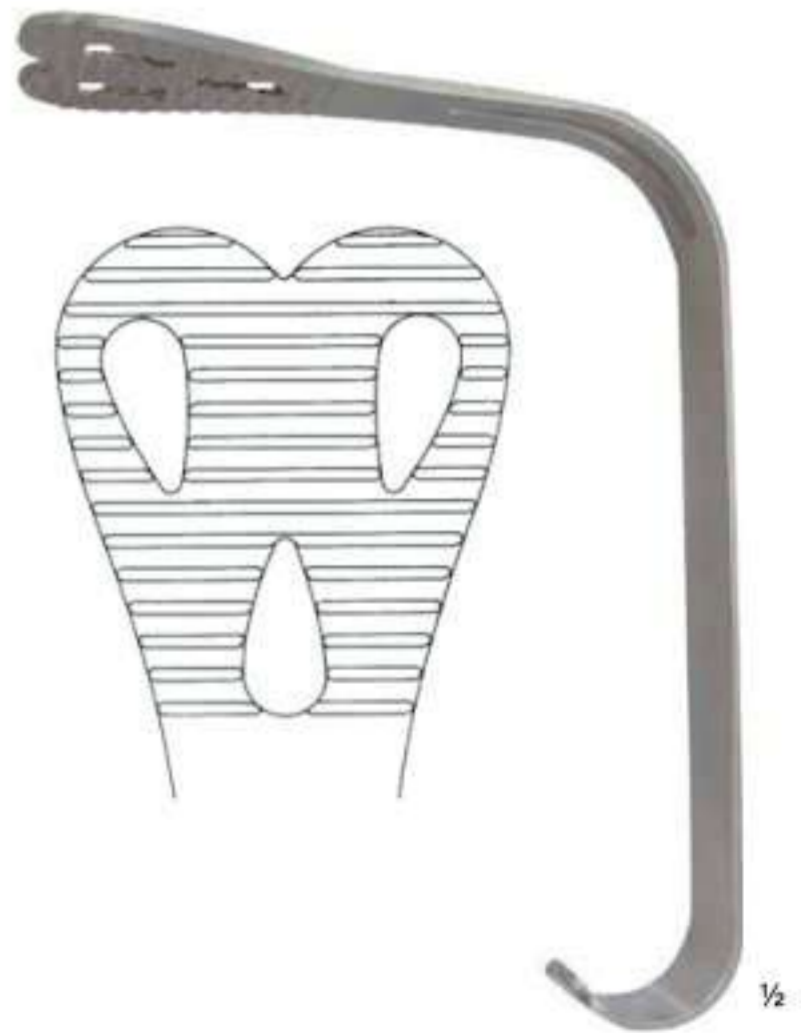

WIEDER		
14 cm/5 1/2"	38 mm	HP-4297-38
15 cm/6"	45 mm	HP-4297-45

Beveled edge



**OBWEGESER**  
18 cm/7"



**HP-1130-06**  
6 mm



**HP-1130-09**  
9 mm



**HP-1130-07**  
7 mm



**HP-1130-11**  
11 mm

Flat edge



**OBWEGESER**  
18 cm/7"



**HP-1132-06**  
6 mm



**HP-1132-09**  
9 mm



**HP-1132-07**  
7 mm



**HP-1132-11**  
11 mm



**BOIES**  
**HP-1282-19**  
19.5 cm/8"

Ramus periosteal stripper



**OBWEGESER**  
20.5 cm/8"



**HP-1152-05**  
5 mm

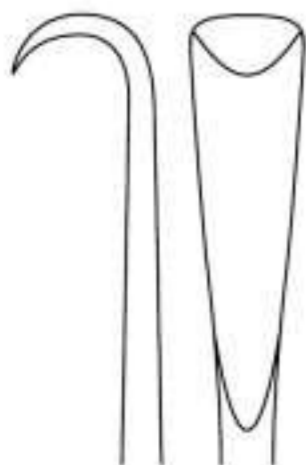

**HP-1152-09**  
9 mm

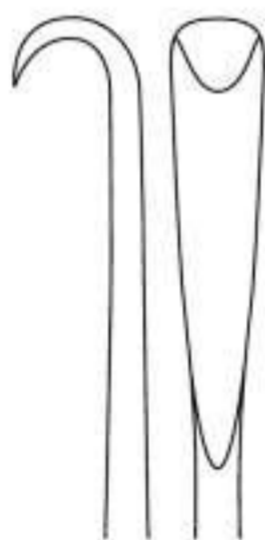

**HP-1152-07**  
7 mm

Ramus periosteal stripper V-notched



**OBWEGESER**  
17.5 cm/7"



**HP-1150-07**  
7 mm

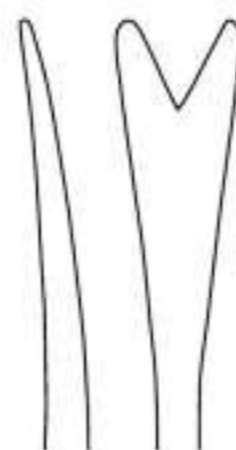

**HP-1150-09**  
9 mm

Mandibular stripper/inferior border raspatory

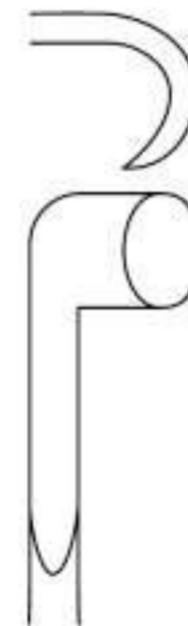

**HP-1140-01**  
left

10 mm



**HP-1140-02**  
right



**OBWEGESER**  
18 cm/7"

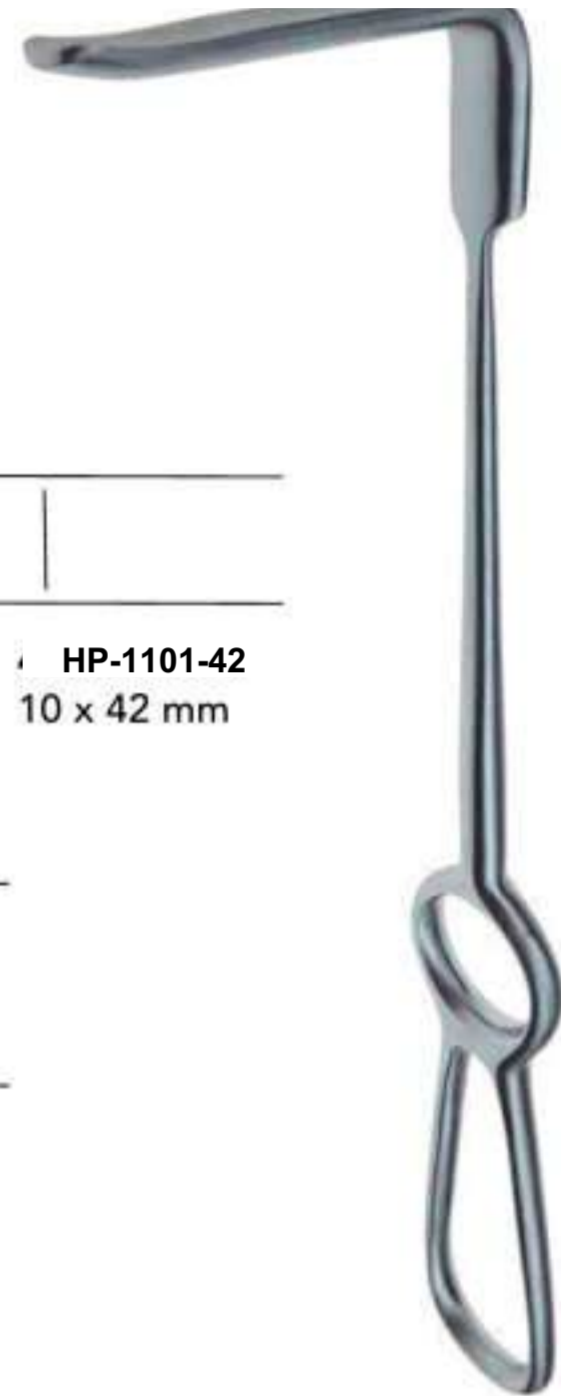
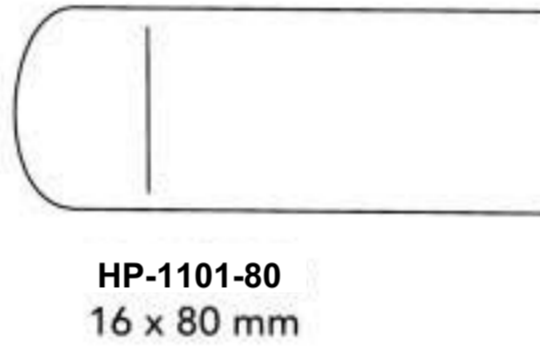
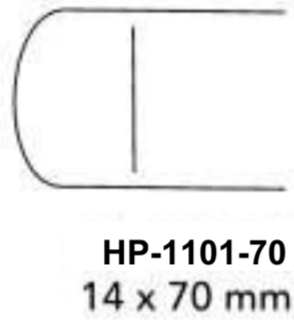
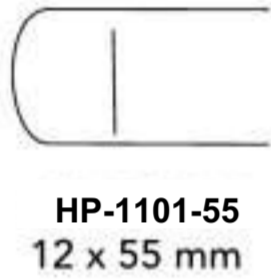
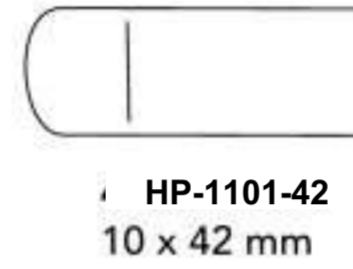
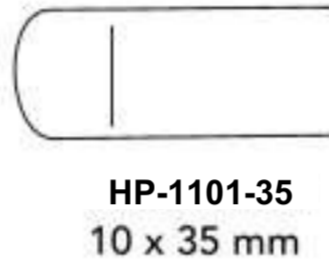
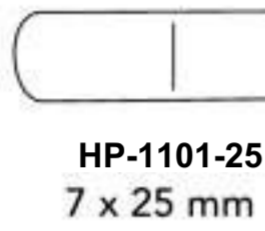
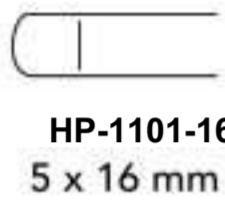
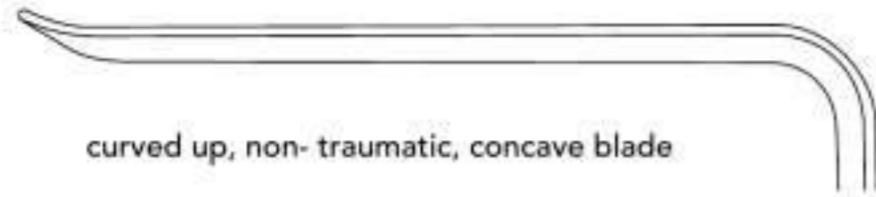

**OBWEGESER**  
22 cm/8<sup>3</sup>/<sub>4</sub>"

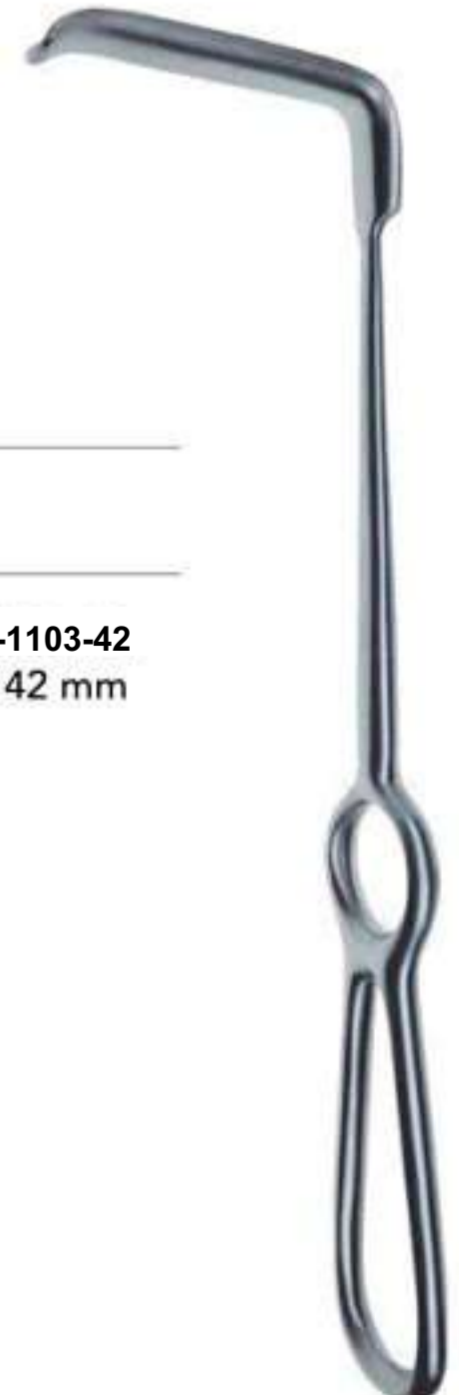
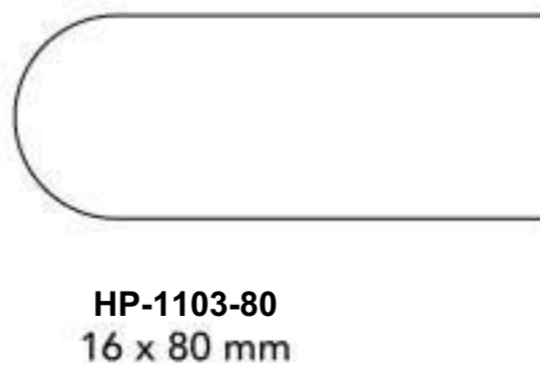
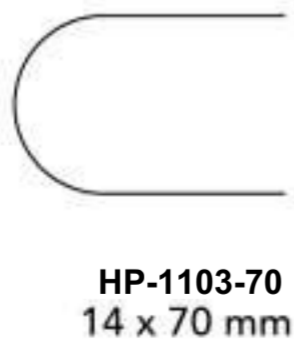
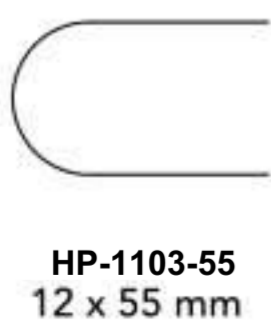
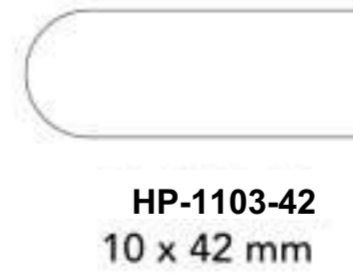
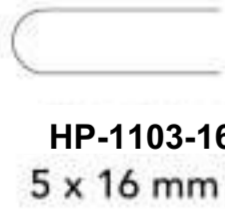
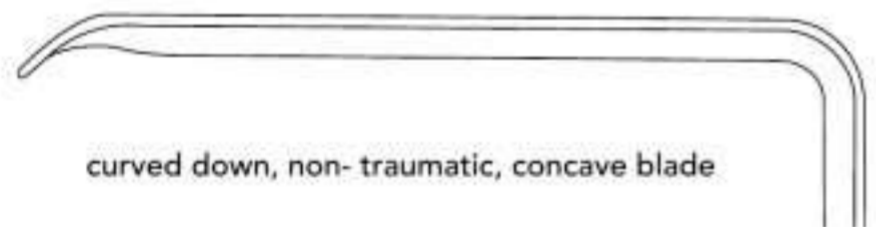

**OBWEGESER**  
22 cm/8<sup>3</sup>/<sub>4</sub>"



Mandibular channel retractors

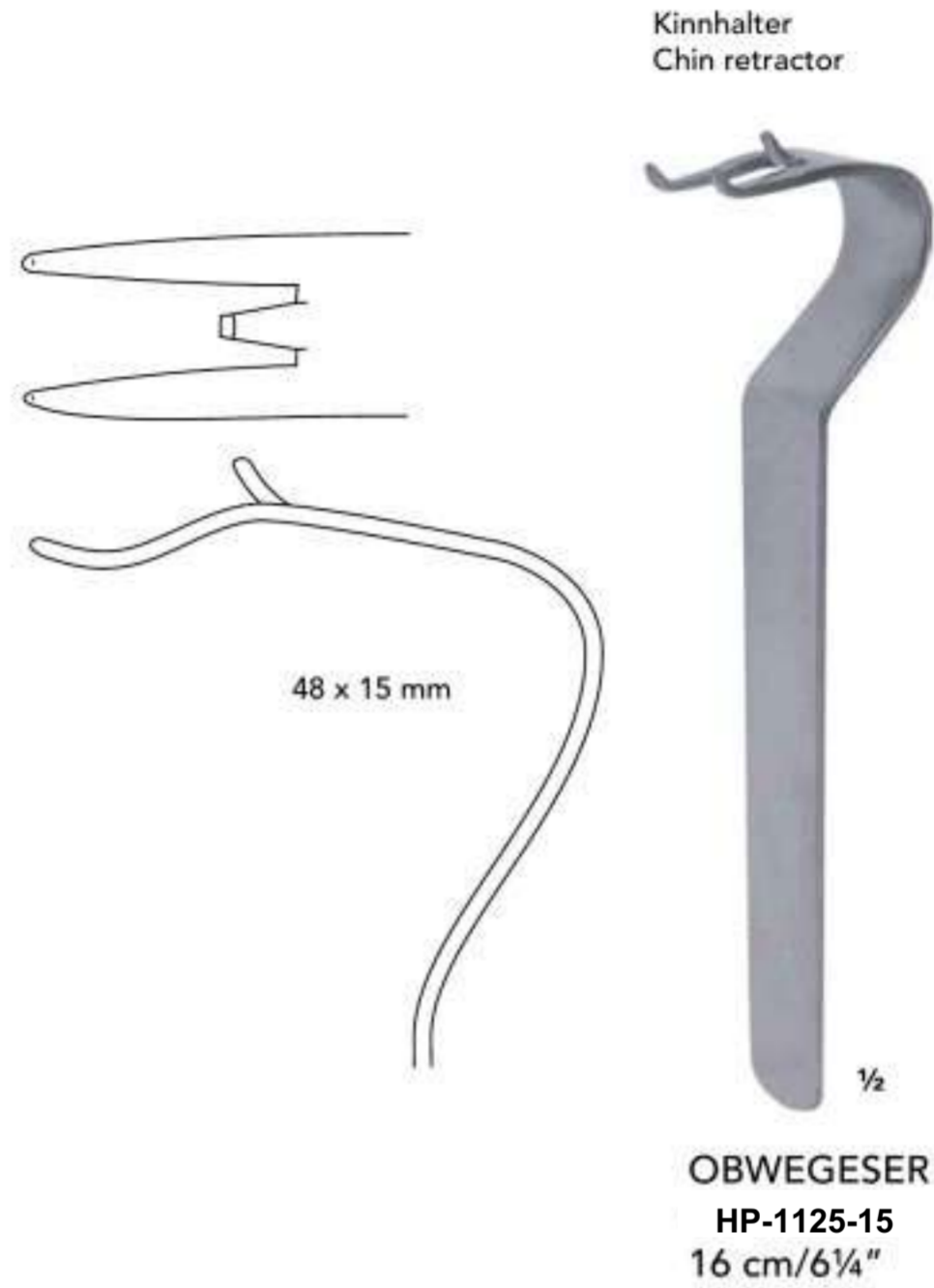
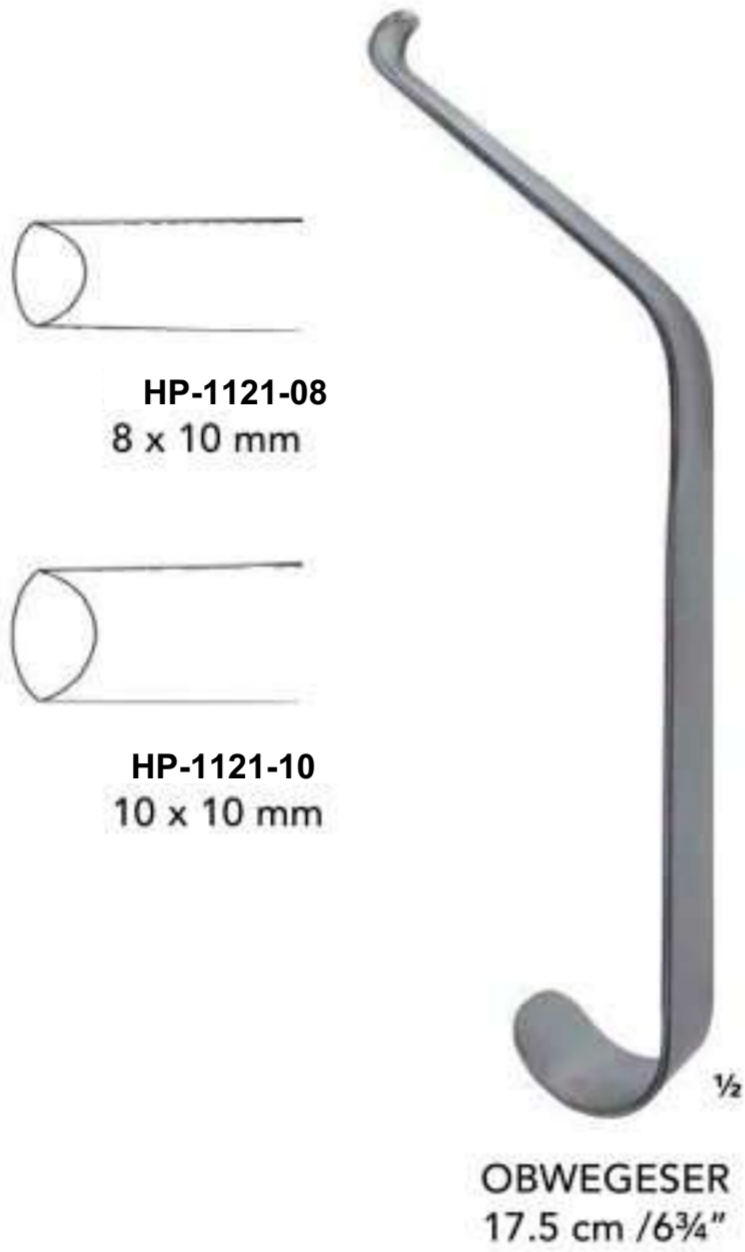

Mandibular retractors

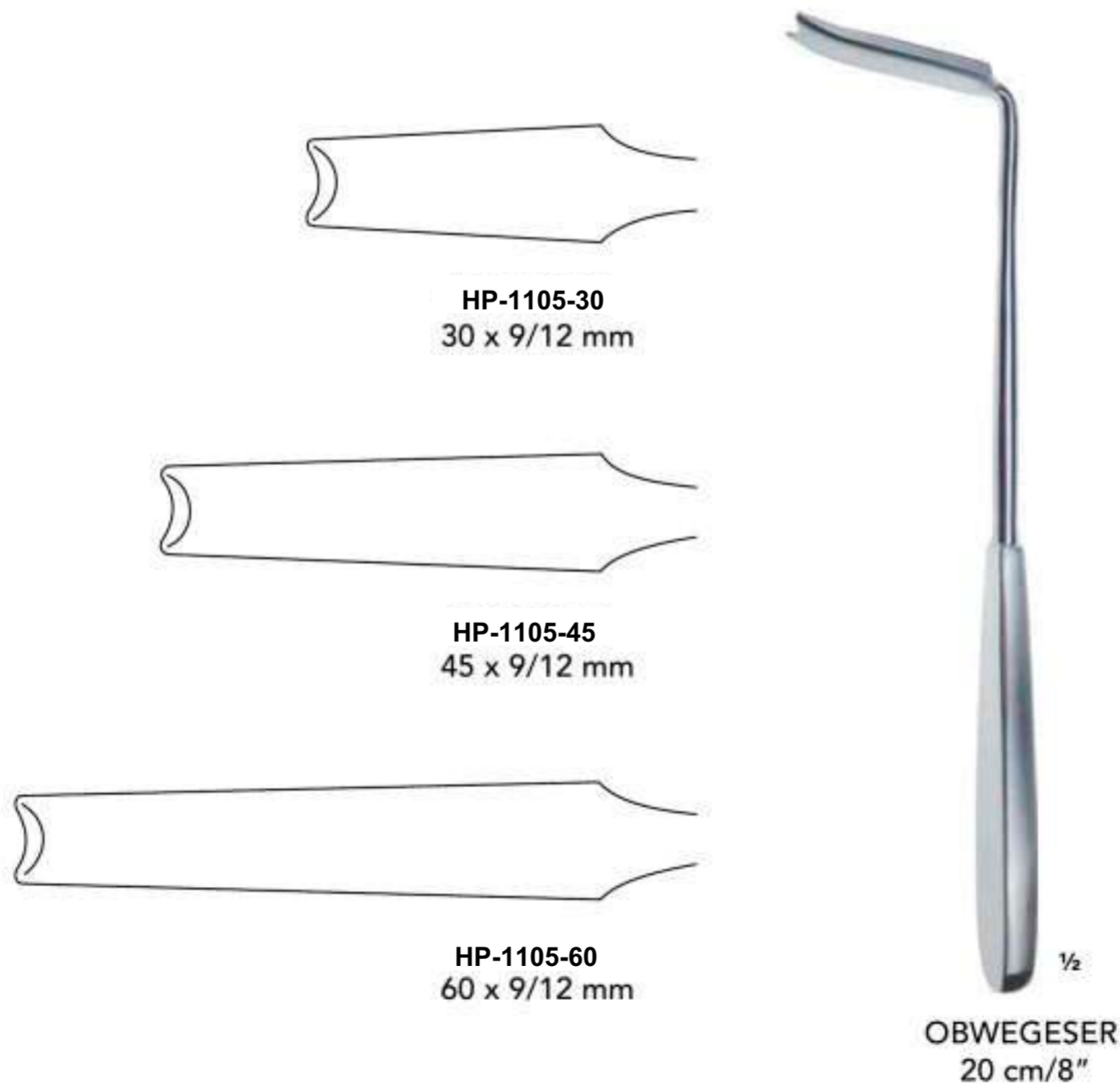

**Ramus Retractors**

**Oral & Maxili Facial**

Ramus retractor

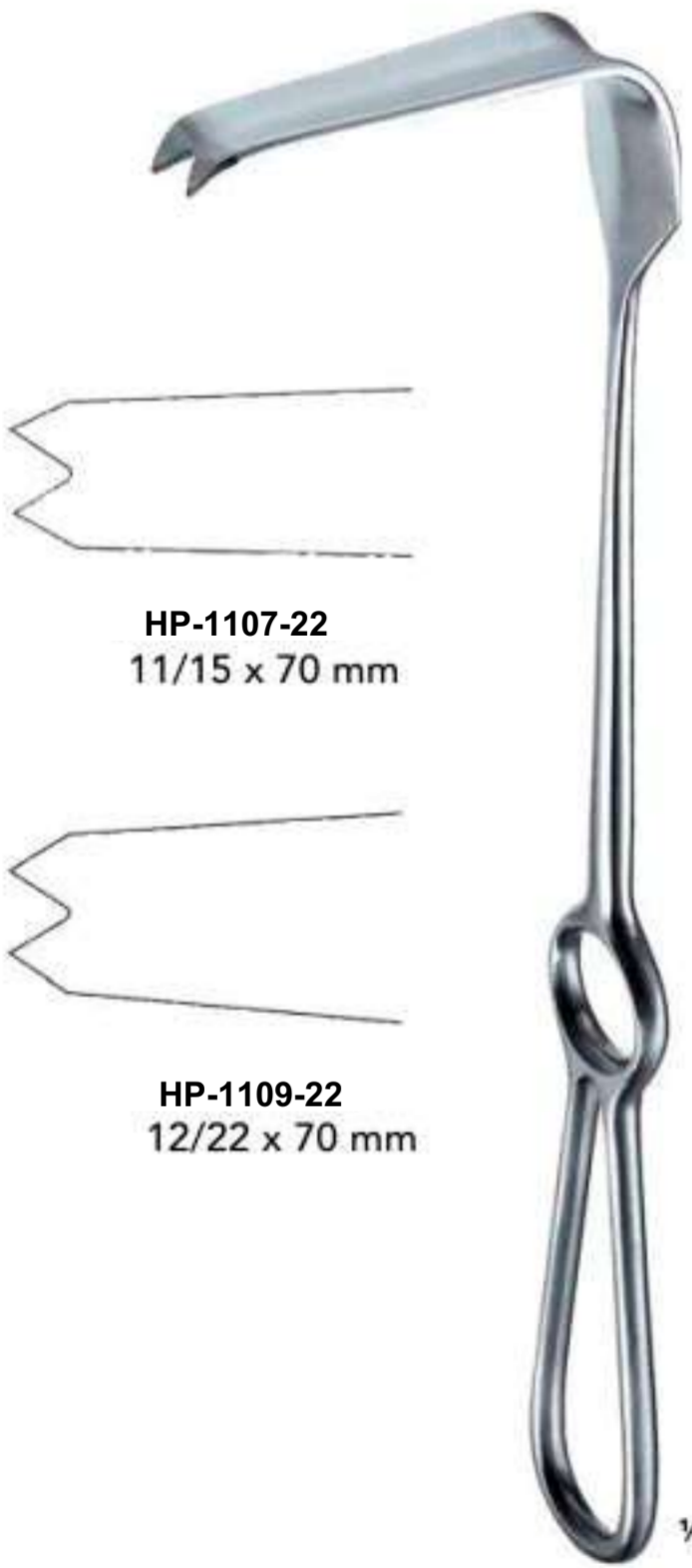

**HP-1107-22**  
11/15 x 70 mm

**HP-1109-22**  
12/22 x 70 mm

**OBWEGESER**  
24.5 cm/9¾"

Notched alveolar retractor

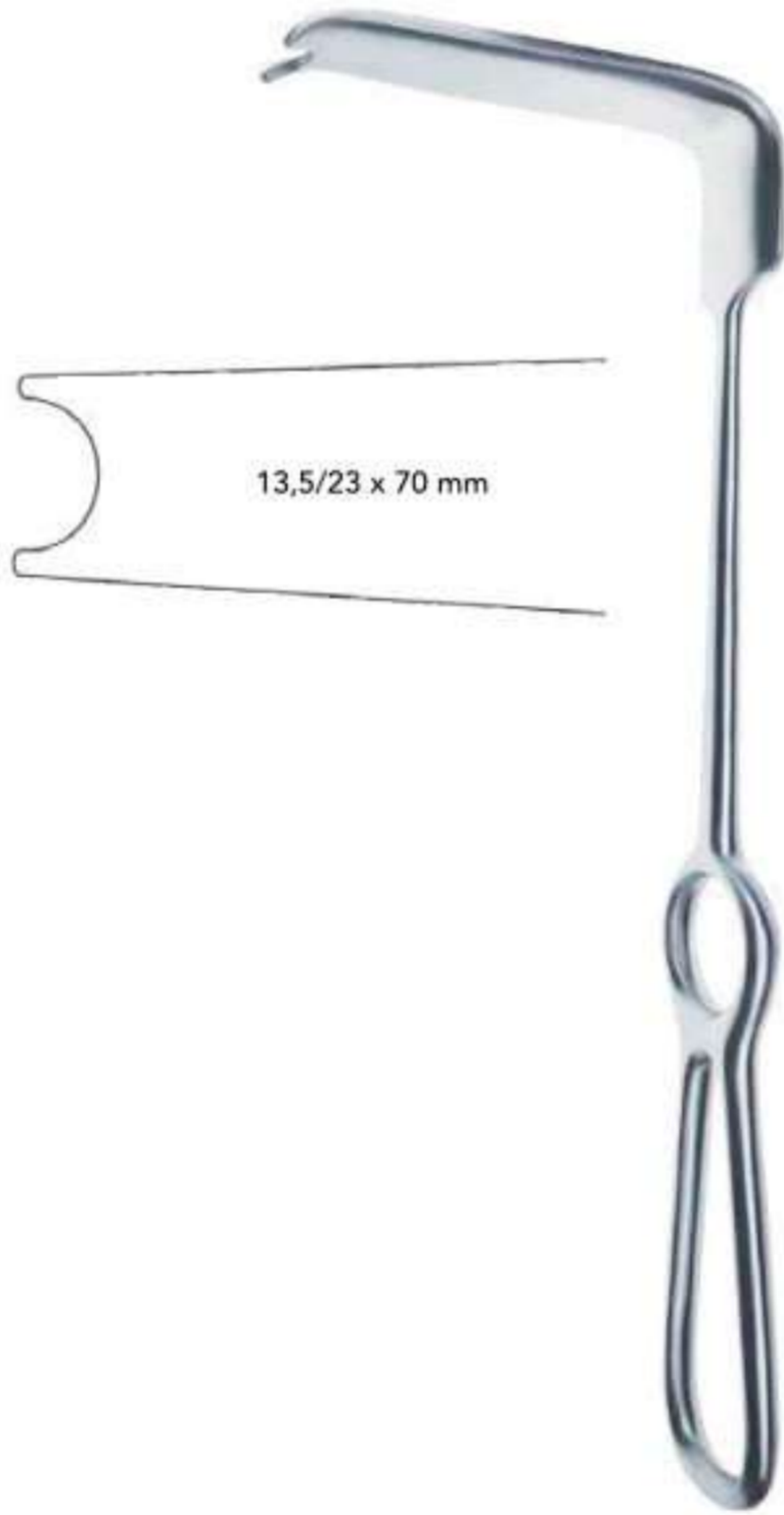

13,5/23 x 70 mm

**OBWEGESER**  
**HP-1111-22**  
22 cm/9"

Nasal spine retractor



10/23 x 40 mm

**OBWEGESER**  
**HP-1113-22**  
24.5 cm/9¾"

Osteotomes for alveolar process

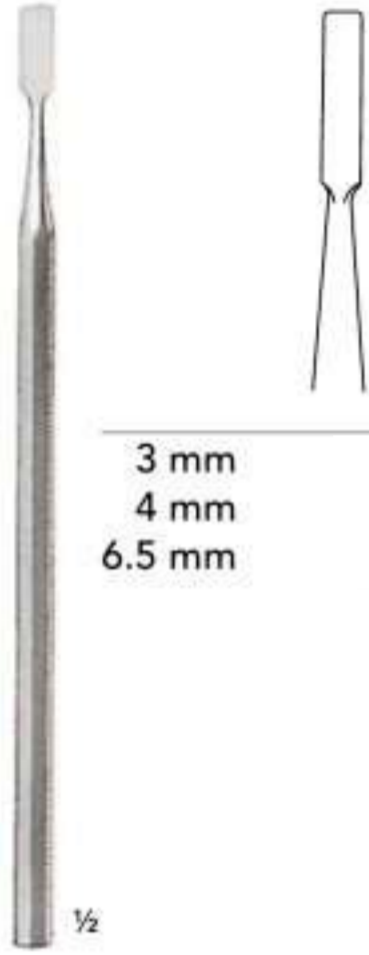

3 mm HP-1668-03  
4 mm HP-1668-04  
6.5 mm HP-1668-06

OBWEGESER  
15.5 cm/6"

Osteotomes

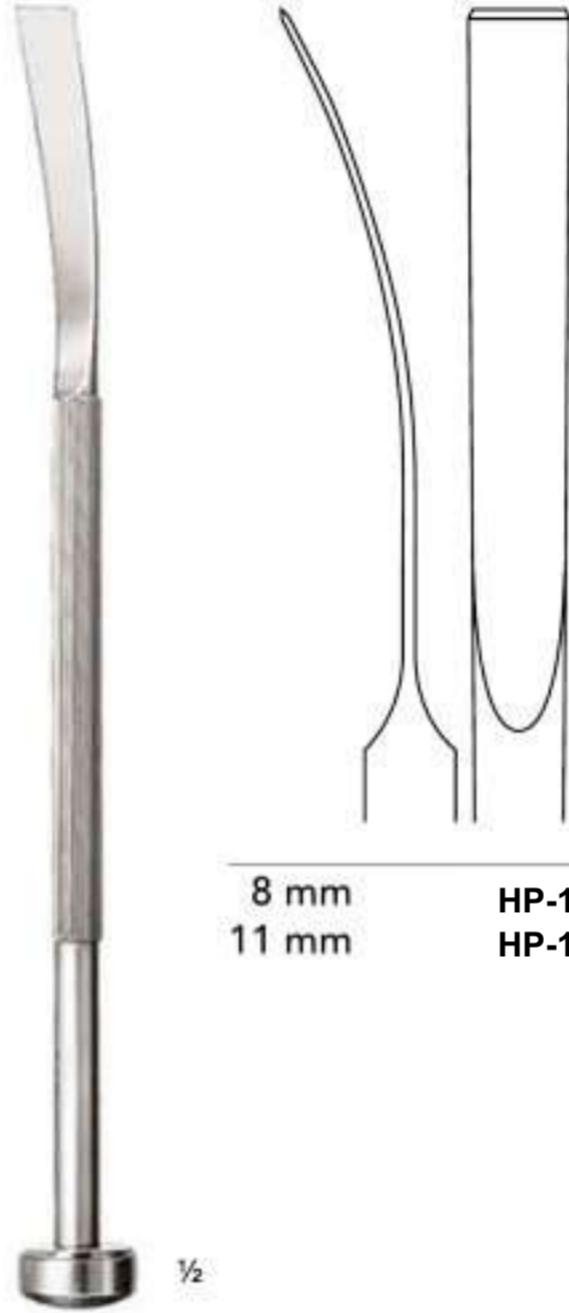

8 mm HP-1667-08  
11 mm HP-1667-11

OBWEGESER  
21 cm/8¼"

Maxillary mobilizer

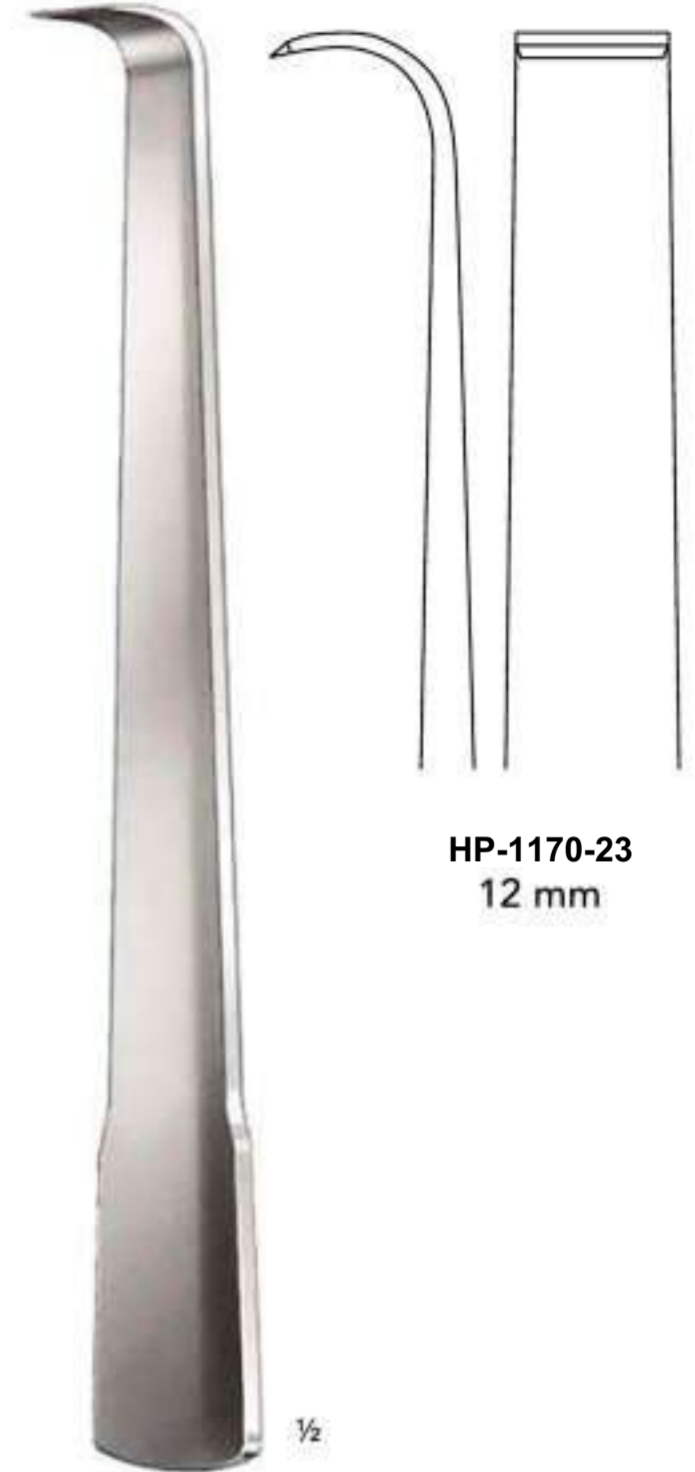

HP-1170-23  
12 mm

OBWEGESER  
23 cm/9"

convex / concave



HP-1220-01  
12 x 30 mm

Bone contouring forceps  
½

OBWEGESER  
17 cm/6¾"

concave / convex



HP-1220-02  
13.5 x 30 mm

Bone contouring forceps  
½

OBWEGESER  
17.5 cm/7"

flat / flat

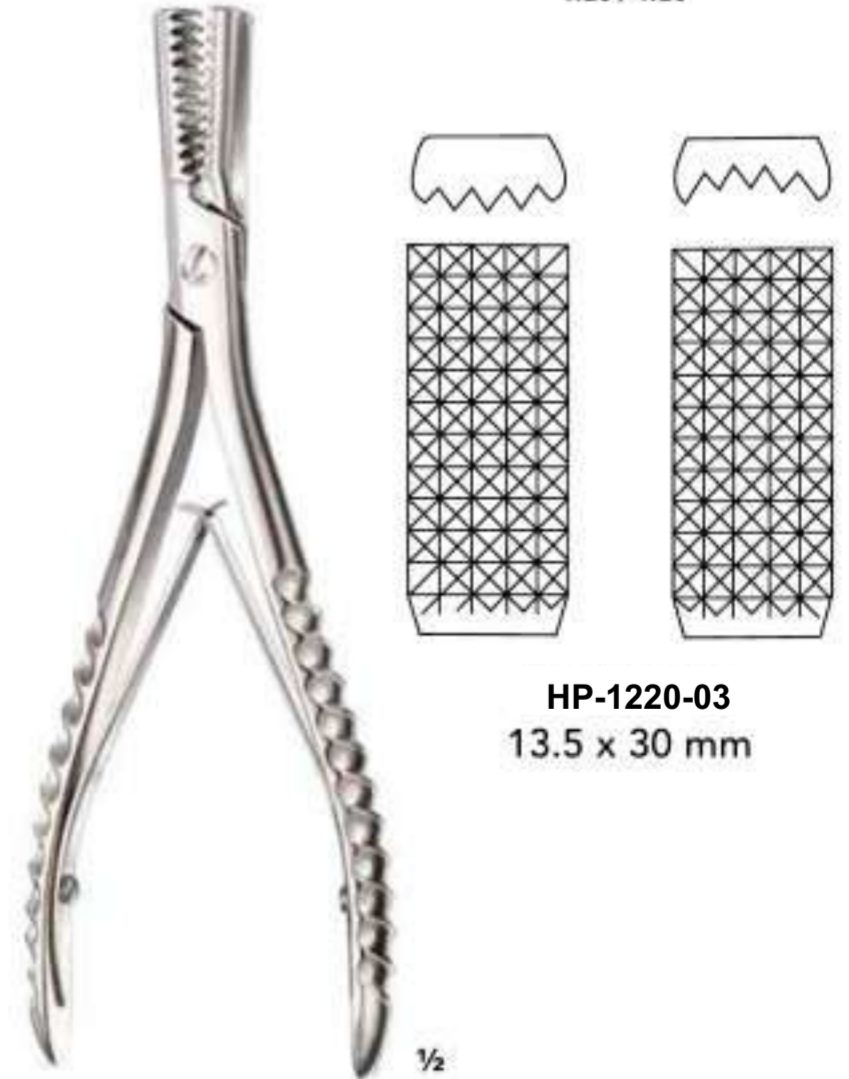

HP-1220-03  
13.5 x 30 mm

OBWEGESER  
17.5 cm/7"

Extra oral Signotch Retractors

9,5 mm x 16 mm



1/2

**HP-1501-23**  
23 cm/10"



1/2

**HP-1503-23**  
23 cm/10"

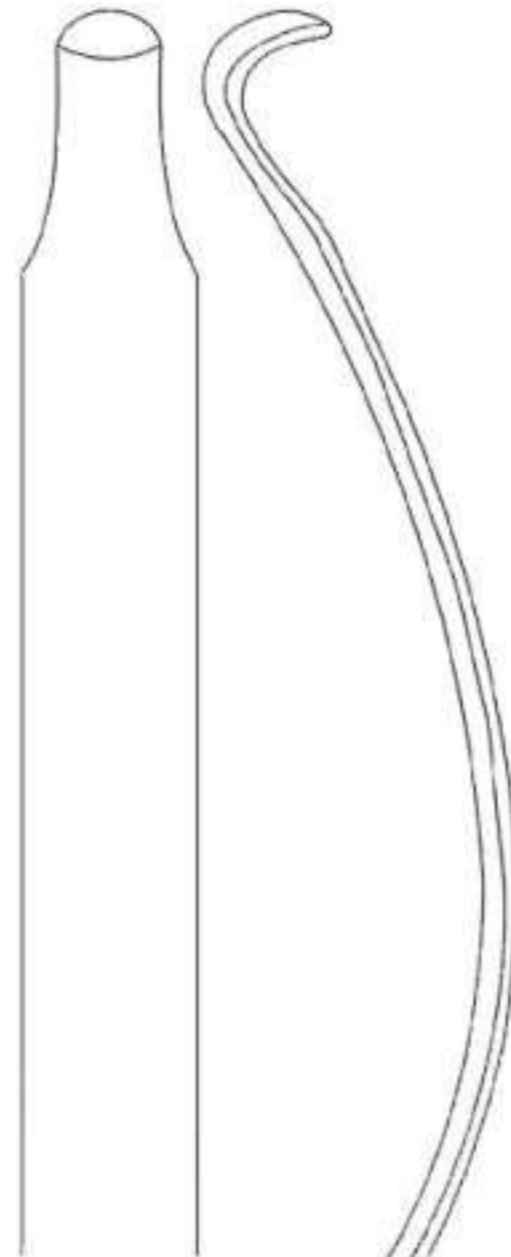

1/2

**ECKELT**  
**HP-1504-25**  
25.5 cm/10"



1/2

**ECKELT**  
**HP-1505-25**  
25.5 cm/10"

for right cheek



1/2

**BAUER**  
**HP-1509-21**  
21 cm/8 1/4"

for left cheek



1/2

**BAUER**  
**HP-1511-21**  
21 cm/8 1/4"

26,5 mm x 16 mm

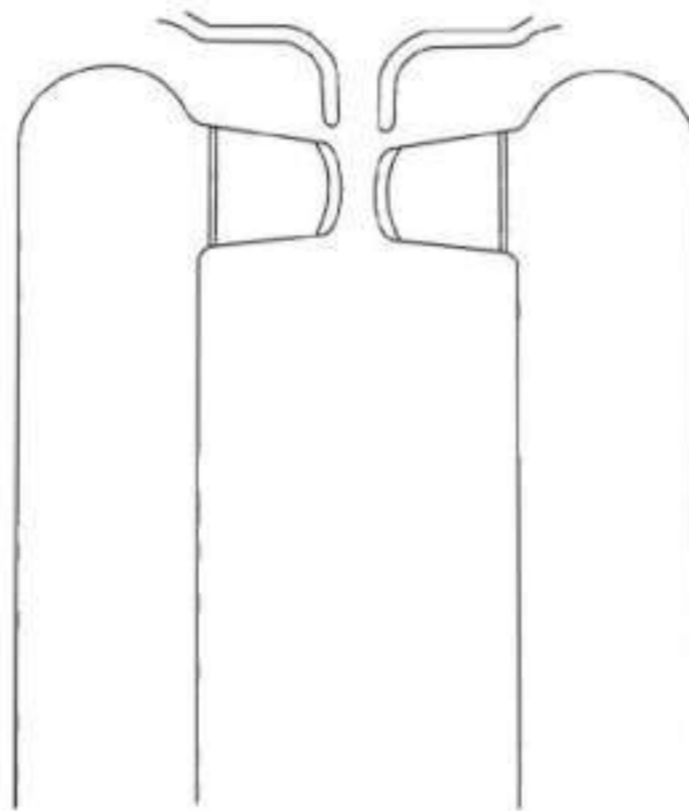

for right cheek



1/2

**BAUER**  
**HP-1513-24**  
24.5 cm/9"

for left cheek



1/2

**BAUER**  
**HP-1515-24**  
24.5 cm/9"

25,5 mm

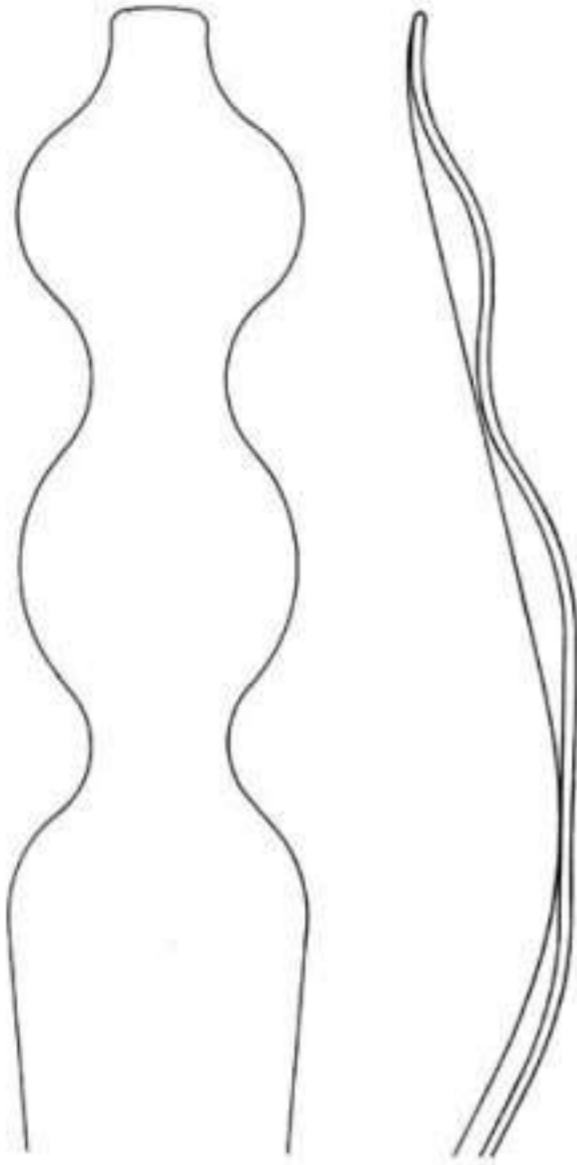

for LeFort osteotomies



**PETRI-PTERYGOID**  
**HP-1505-23**  
23 cm/9"



**PETRI-PTERYGOID**  
**HP-1507-23**  
23 cm/9"

12,5 mm / 27 mm

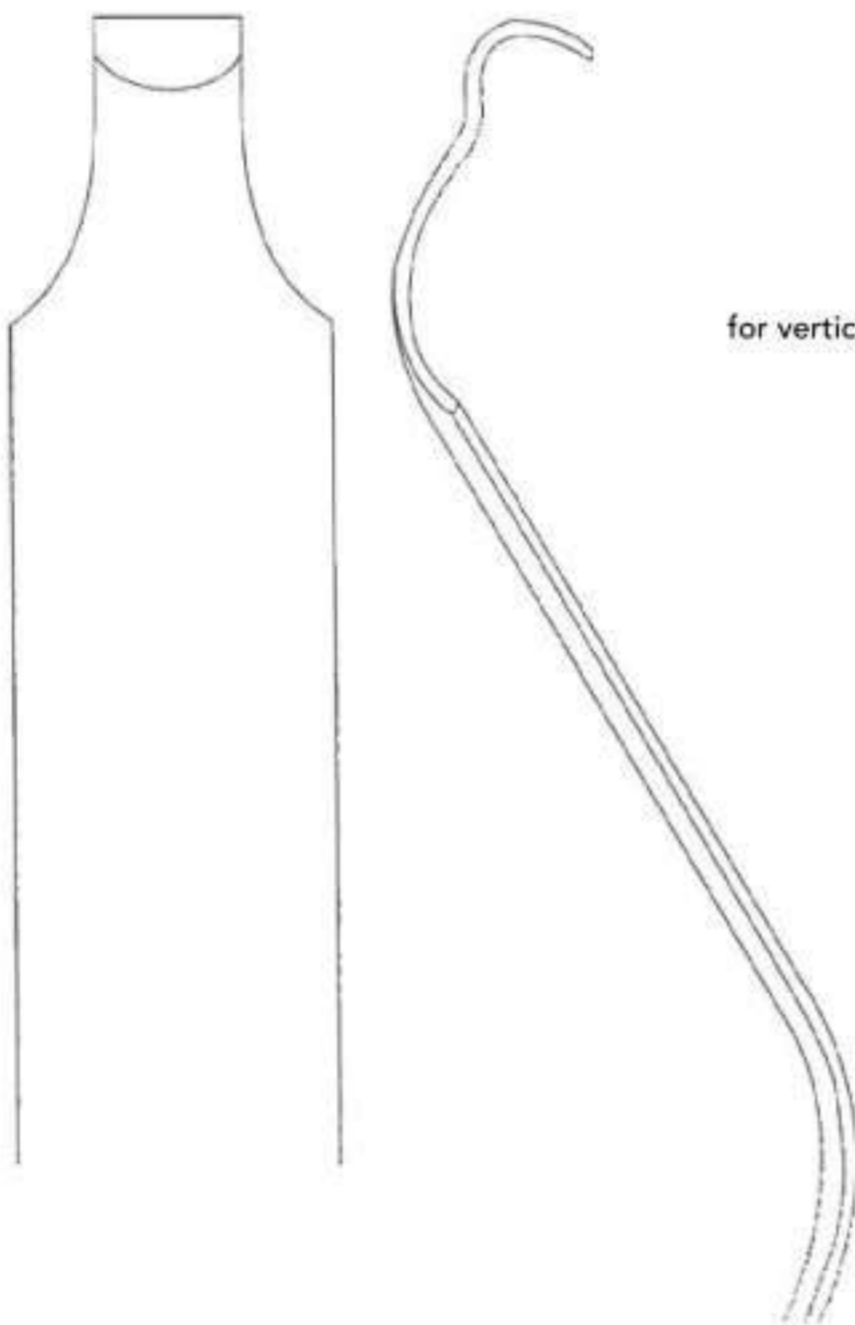

for vertical osteotomies



**LEVASSEUR-MERRIL**  
**HP-1517-25**  
25 cm/9¾"



**LEVASSEUR-MERRIL**  
**HP-1519-25**  
25 cm/9¾"

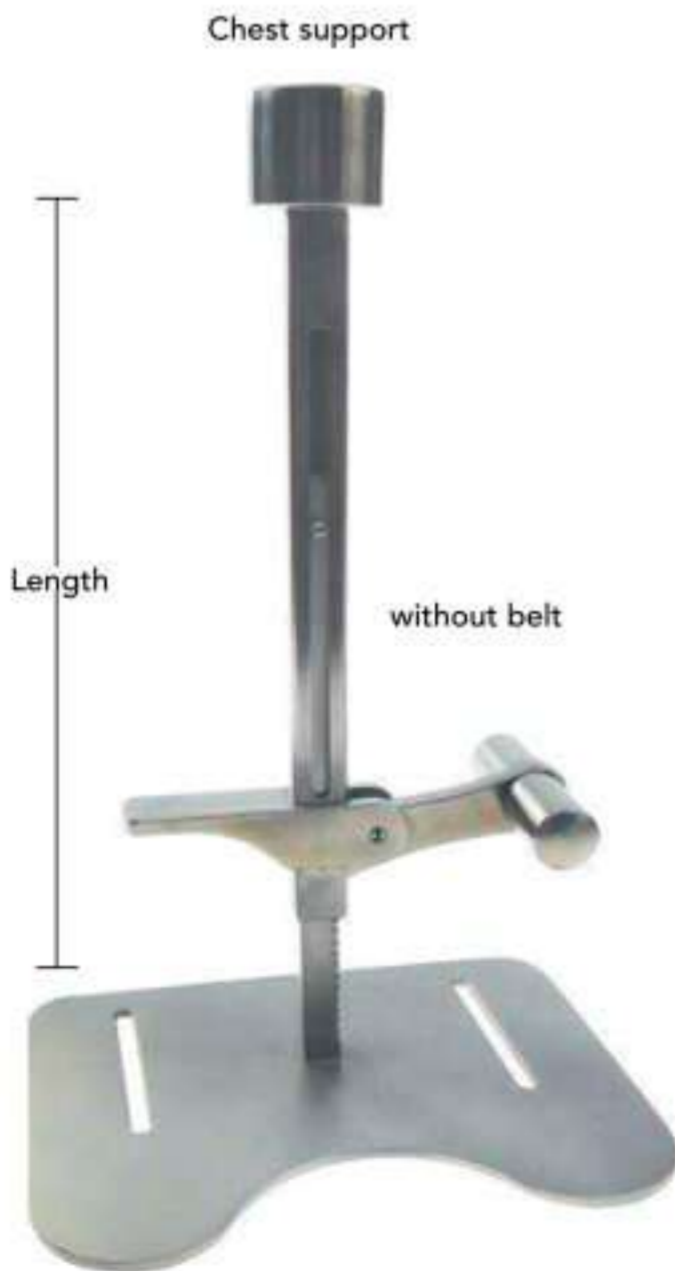
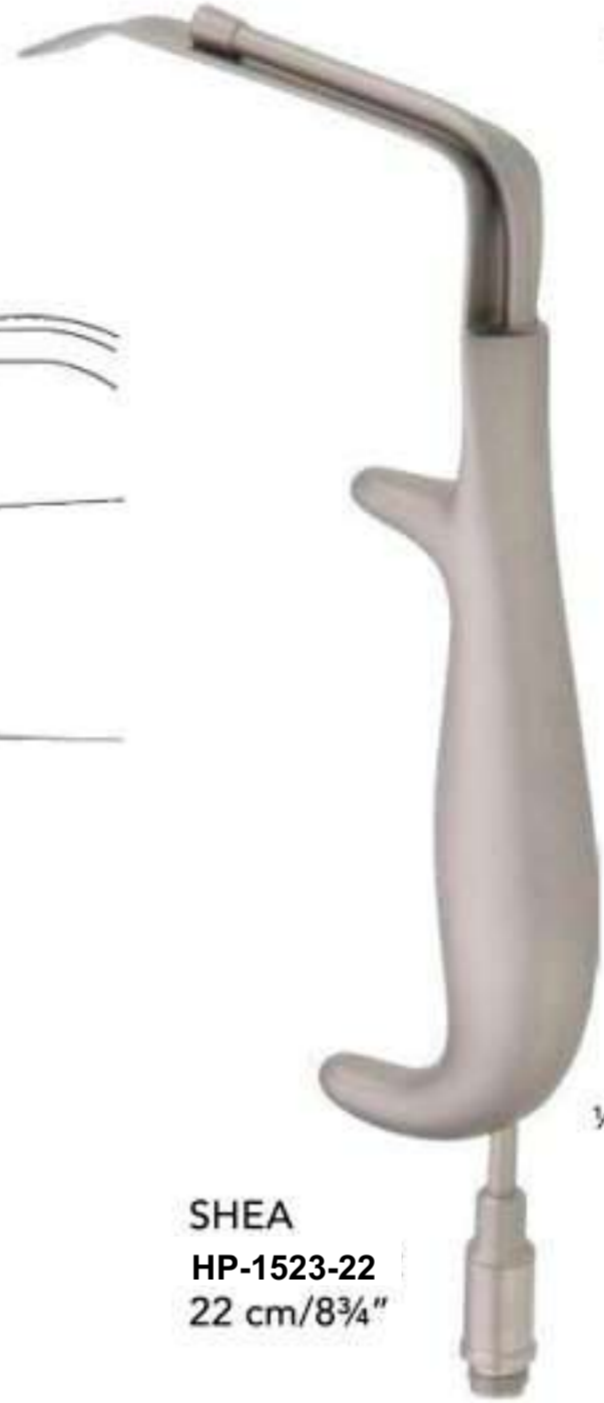
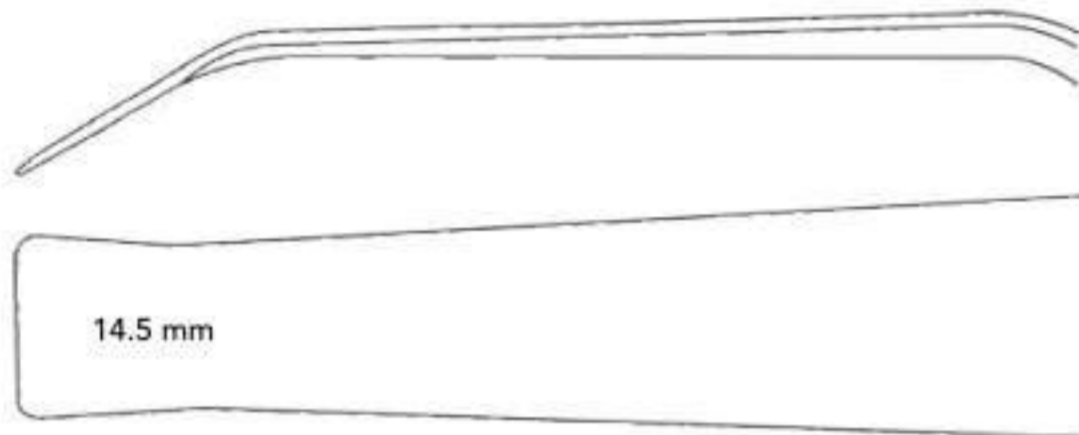

Length	NEGUS
85 mm	HP-4408-85
140 mm	HP-4408-40



HP-1199-15  
15 cm/6"



HP-1197-21  
21 cm/8 1/4"



HP-1198-26  
26 cm/10 1/4"

Our Range of Best Selling Instruments

# ENT INSTRUMENTS CATALOGUE



+92 (326) 877 8787



[www.healproinstruments.com](http://www.healproinstruments.com)



[info@healproinstruments.com](mailto:info@healproinstruments.com) | [healprohealthproduct@gmail.com](mailto:healprohealthproduct@gmail.com)



MuradPur New Abadi, Near Police Station, Sialkot - 51310 Pakistan

